

# NAMUR Interface 3 Port Solenoid Valve

# VFN200N Series



The interface surface complies with NAMUR.

- Can be directly installed on the industrial valve actuator that complies with NAMUR.



## How to Order

VFN212 N - 5 D Z - 02 F - - -

NAMUR Interface

Voltage

1	100 VAC, 50/60 Hz
2	200 VAC, 50/60 Hz
3	110 to 120 VAC, 50/60 Hz
4	220 VAC, 50/60 Hz
5	24 VDC
6	12 VDC
7	240 VAC, 50/60 Hz

For other rated voltages, please contact SMC.

Electrical entry

G	Grommet
E	Grommet terminal
T	Conduit terminal
D	DIN terminal
DO	DIN terminal (Without connector)
Y <sup>(Note)</sup>	DIN terminal
YQ <sup>(Note)</sup>	DIN terminal (Without connector)

Note) Conforming to DIN 43650, Form B

Thread type

Nil	Rc (PT)
F	G (PF)
N	NPT

Solenoid

Nil	Single solenoid
D	Double solenoid

Manual override

Nil	Non-locking push type (Flush)
A	Non-locking push type (Extended)
B	Locking type (Tool required)

Light/Surge voltage suppressor

Nil	None
Z	With light/surge voltage suppressor
S <sup>(Note)</sup>	With surge voltage suppressor

Note) Available for grommet type only.

Nil	—
Q	CE/UKCA marked product

## Specifications

### Symbol

Single solenoid

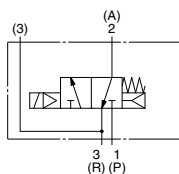

Double solenoid

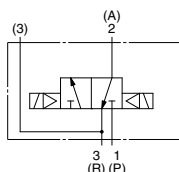

Valve specifications		Valve construction	Rubber seal	
		Fluid	Air	
		Valve type	Normally closed	
		Max. operating pressure	0.9 MPa (130 psi)	
		Min. operating pressure	0.15 MPa (22 psi)	
		Ambient and fluid temperature	-10 to +60°C Note 1)	
		Lubrication	Not required Note 2)	
		Pilot valve manual override	Non-locking push type (Flush/Extended)/Locking type (Tool required)	
		Enclosure	Dustproof	
		Port size	1/4	
		Cv factor (Effective area)	Refer to "Flow Rate Characteristics" table below.	
		Weight	Refer to "Weight" table below.	
		Other	Cylinder ports should be NAMUR hole pattern.	
Electrical specifications		Coil rated voltage	12, 24 VDC, 100, 110 to 120, 200, 220, 240 VAC (50/60 Hz)	
		Allowable voltage fluctuation	-15 to +10% of rated voltage	
		Coil insulation type	Class B or equivalent	
		Apparent power AC (Power consumption)	Inrush	5.0 VA/60 Hz, 5.6 VA/50 Hz
		Power consumption DC	Holding	2.3 VA (1.5 W)/60 Hz, 3.4 VA (2.1 W) 9/50 Hz
		Electrical entry	1.8 W	
			Grommet, Grommet terminal, Conduit terminal, DIN terminal	

Note 1) Use dry-air at low temperature.

Note 2) Use turbine oil No.1 (ISO VG32), if lubricated.

## Flow Rate Characteristics

		Flow rate characteristics					
		1→2 (P→A)			2→3 (A→R)		
		C	b	Cv	C	b	Cv
2-position	Single solenoid	2.68	0.40	0.72	5.41	0.31	1.38
	Double solenoid	2.68	0.40	0.72	5.41	0.31	1.38

## Weight

Model	Weight (g)
VFN212N-5D-02F	240
VFN212N-5D-02F-D	380

# VFN200N Series

## Dimensions

### DIN terminal

VFN212N-□<sup>D</sup>(Y)□□-02□-□

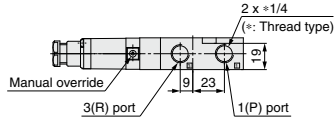
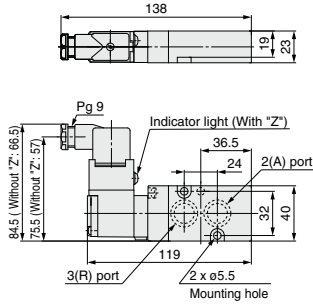
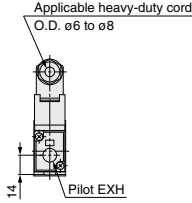

### DIN terminal

VFN212N-□<sup>D</sup>(Y)□□-02□-D-□

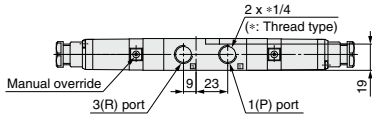
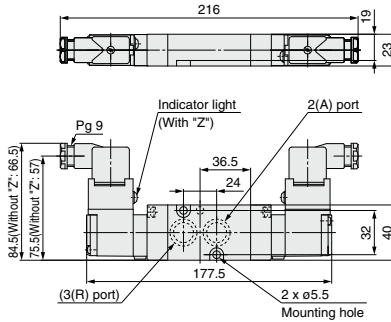
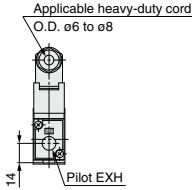

### Grommet

VFN212N-□G□□-02□-□-□

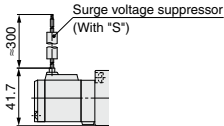

### Conduit terminal

VFN212N-□T□□-02□-□-□



### Grommet terminal

VFN212N-□E□□-02□-□-□

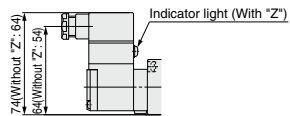
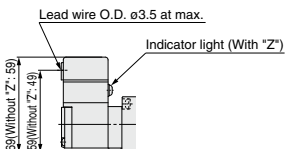

**NAMUR Mounting Pattern**

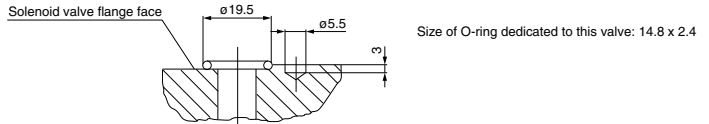
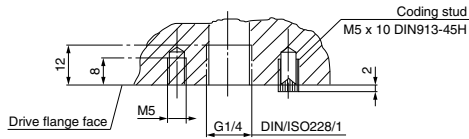
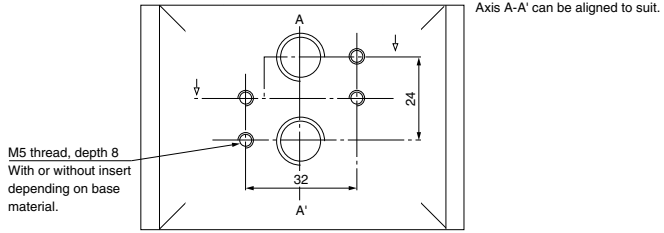

The solenoid valve can be attached with 2 mounting bolts.  
The positioning of the coding stud hole is left up to the manufacturer and thus also determines the location of the coding stud.

<b>IP</b>
<b>IW</b>
<b>1301</b>
<b>AW</b>
IL1 <input type="checkbox"/>
IL2 <input type="checkbox"/>
<b>IT</b>
CP <input type="checkbox"/>
<b>IS</b>
<b>VFN</b>
IN- T <input type="checkbox"/>