

# Compact Regulator

## ARX20 Series

2.0 MPa compatible, piston type compact regulator



- Compatible with inlet supply pressure of 2.0 MPa
- Compact type (face to face dimensions 35 mm, overall length 80 mm)
- Piston type
- 3 out ports for convenient use
- Employs a knob shape for easy operation
- Ideal for discharge pressure adjustment on a small compressor
- Ideal for pressure adjustment of air blowing applications

ARJ

AR425  
to 935

ARX

AMR

ARM

ARP

IR□-A

IR

IRV

VEX

SRH

SRP

SRF

ITV

IC

ITVH

ITVX

PVQ

VY1

VBA  
VBAT

AP100

# Compact Regulator

# ARX20 Series

## How to Order

**ARX2** 0 —    01   

**Regulator for 2 MPa**

**Regulating pressure range**

<b>0</b>	0.05 to 0.85 MPa
<b>1</b> Note 1)	0.05 to 0.30 MPa

**Thread type**

<b>Nll</b>	Rc
<b>N</b>	NPT
<b>F</b>	G

**Port size**

<b>01</b>	1/8
<b>02</b>	1/4

**Option**

<b>Nll</b>	None		
<b>B</b>	Bracket	1348112	
<b>G</b>	Pressure gauge Note 2)	ARX20- Nll F <input type="checkbox"/>	G36-10-01 G46-10-02
		ARX21- Nll F <input type="checkbox"/>	G36-4-01 G46-4-02
	ARX20-N <input type="checkbox"/>	G36-P10-N01-X30 G46-P10-N02-X30	
	ARX21-N <input type="checkbox"/>	G36-P4-N01-X30 G46-P4-N02-X30	
<b>P</b>	Panel nut	1348110A	

**Option combination numbers**

<b>B</b>	<b>BG</b>	* Panel nut is also included with B.
<b>G</b>	<b>GP</b>	
<b>P</b>		

Note 1) Compared with ARX20, ARX21 is the product which adjusting spring has only been changed.

It is not the product, which does not allow the pressure more than 0.3 MPa.

Note 2) Pressure gauges are shipped together, (but not assembled).

## Specifications



Symbol



Model		ARX20
<b>Regulator construction</b>		Piston type regulator
<b>Relief mechanism</b>		Relieving type
<b>Port size</b>		Rc 1/8, 1/4
<b>Pressure gauge port size</b>		Rc 1/8, 1/4
<b>Proof pressure</b>		3.0 MPa
<b>Maximum operating pressure</b>		2.0 MPa
<b>Regulating pressure range</b>	<b>Standard type</b>	0.05 to 0.85 MPa
	<b>Low pressure type</b>	0.05 to 0.3 MPa
<b>Fluid</b>		Air
<b>Ambient and fluid temperature</b>		-5 to 60°C (No freezing)
<b>Weight</b>		110 g

## Flow Rate Characteristics (Representative Value)

### ARX20-01

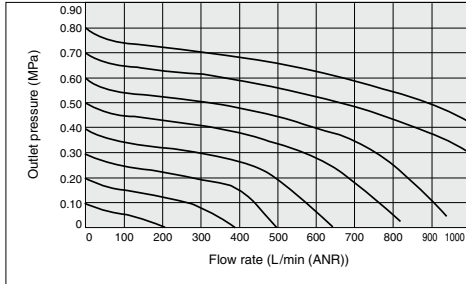

### ARX20-02

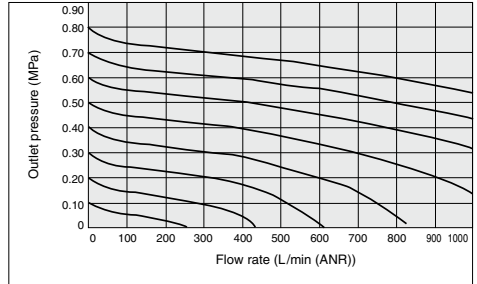

Inlet pressure: 2.0 MPa

### ARX21-01

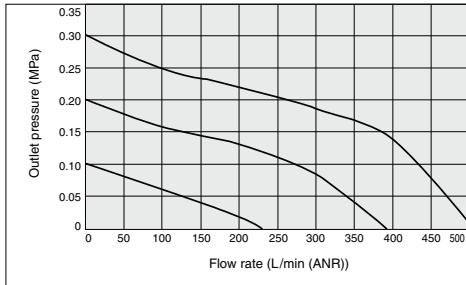

### ARX21-02

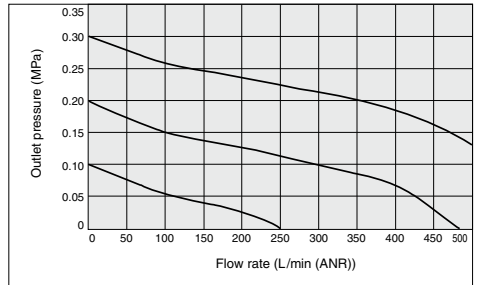

## Pressure Characteristics (Representative Value)

### ARX20

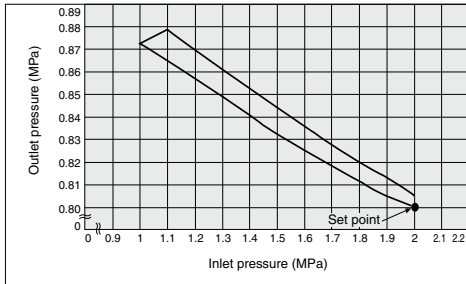

### ARX21

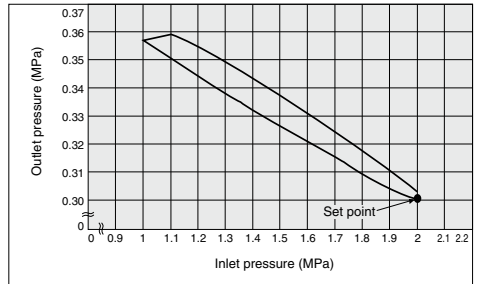

ARJ

AR425  
to 935

ARX

AMR

ARM

ARP

IR□-A

IR

IRV

VEX

SRH

SRP

SRF

ITV

IC

ITVH

ITVX

PVQ

VY1

VBA  
VBAT

AP100

# ARX20 Series

## Construction

### Symbol

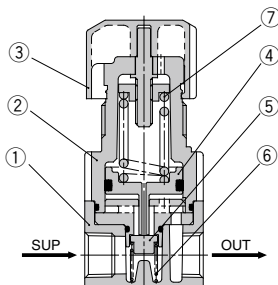
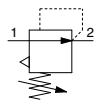

### Component Parts

No.	Description	Material	Note
1	Body	ADC	Chromate treated
2	Bonnet	POM	

### Replacement Parts

No.	Description	Material	Part no.
3	Knob	POM	1348102#1
4	Piston assembly	POM, NBR	1348104A
5	Valve	Brass, NBR	1348114#1
6	Valve spring	Stainless steel	1348109
7	Adjusting spring	Steel wire	1348108 (For 0.85 MPa) 1348108-1 (For 0.3 MPa)

## Dimensions

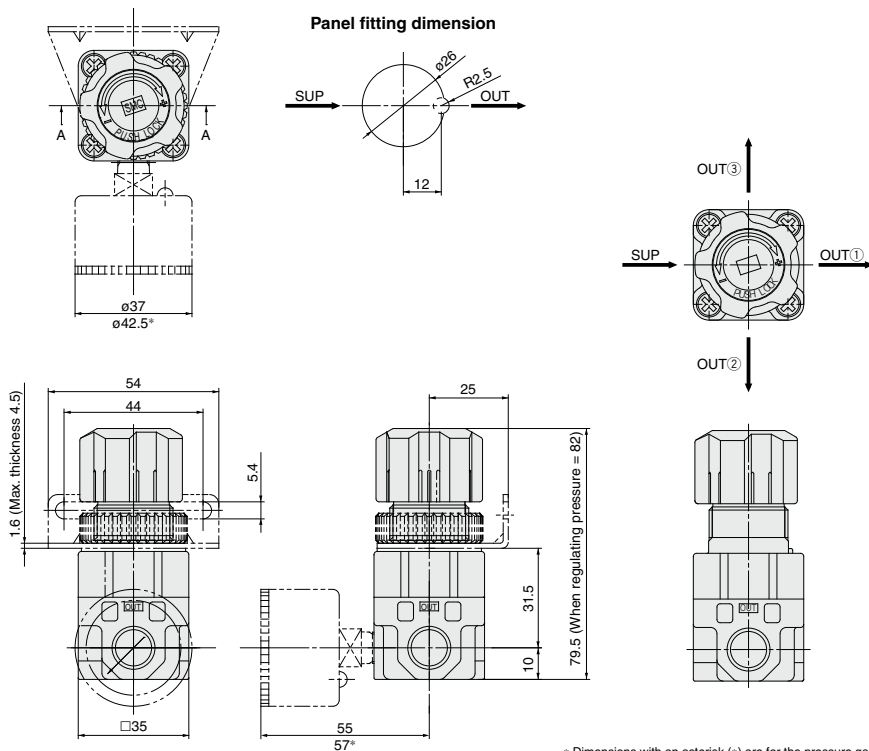

\* Dimensions with an asterisk (\*) are for the pressure gauge G46.

**Option**

**Panel Nut**

Part no.	1348110A
Material	POM, NBR (Gasket)

**Dimensions**

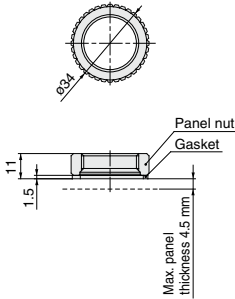

\* Install the gasket underneath the panel and bracket (bonnet side).  
Tighten the panel nut by hand without the use of tools.

**Bracket**

Part no.	1348112#1
Material	SPCC (Zinc chromated)

**Dimensions**

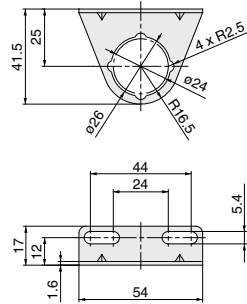

**⚠ Precautions**

Be sure to read this before handling the products.  
Refer to back page 50 for Safety Instructions and pages 387 to 391 for Precautions on every series.

**Design and Selection**

**⚠ Warning**

- 1. Confirm the set pressure range.**  
Be sure to install safety devices in locations where output pressure above the set pressure range could lead to damage or malfunction of equipment in the outlet side.
- 2. Residual pressure relief without inlet pressure.**  
When the inlet pressure is relieved with the outlet pressure in a low pressure setting state, it may not be possible to eliminate the outlet pressure (residual pressure relief). Provide a residual pressure relief circuit when reliable elimination of the outlet pressure must be performed.

**⚠ Caution**

- 1. When operating at an inlet pressure lower than the inlet pressure used in the flow rate characteristics graph, the pressure drop on the outlet side may be greater. Therefore, be sure to conduct testing using the actual equipment.**  
For pressure control equipment selection, refer to page 123 in the "Product Selection Guide."

**Mounting**

**⚠ Caution**

- 1. To set the correct pressure**  
1) Set the pressure by increasing from a lower pressure to the desired setting, and lock the knob after the pressure is set.  
2) Make connections after confirming the "SUP" mark which indicates the air inlet. Reversed connections will cause malfunction.

ARJ

AR425  
to 935

ARX

AMR

ARM

ARP

IR□-A

IR

IRV

VEX

SRH

SRP

SRF

ITV

IC

ITVH

ITVX

PVQ

VY1

VBA  
VBAT

AP100