

5 Port Solenoid Valve

Direct Operated Poppet Type

VK3000 Series

Rubber Seal



C: 0.54 dm³/(s·bar)

(Passage {4/2 → 5/3 (A/B → R1/R2)})

**Compact: Width 18 x
Length 68 (mm)**

Low power consumption

4 W DC (Standard type)

2 W DC (Low wattage type)

Suitable for copper-free applications

All the parts in contact with fluid are non-copper materials

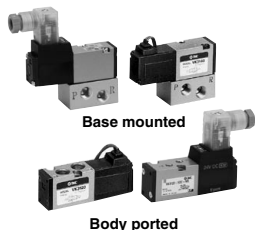

Symbol

Body ported

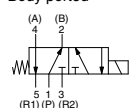

Base mounted

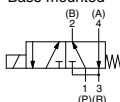

Mounting with VK300

The VK300 series can be mounted on the same manifold base VV5K3 of VK3000 series. For details, refer to the page 1422.

Used as a 3 Port Valve

The VK3000 series can be used as 3 port valve, as a N.C. or N.O. type, by plugging either "A" or "B" cylinder Port. Make sure not to plug the exhaust port "R".

Plug position	B port	A port
Type of actuation	N. C.	N. O.
JIS symbol		

Specifications

Type of actuation	Direct operated type 2 position single solenoid
Fluid	Air
Ambient and fluid temperature	-10 to 50°C (No freezing)
Response time (at the pressure of 0.5 MPa) (1)	10 ms or less (Standard), 15 ms or less (Low wattage type)
Manual override	Non-locking push type
Lubrication	Not required (Use turbine oil Class 1 ISO VG32, if lubricated.)
Mounting orientation	Unrestricted
Impact/Vibration resistance (2)	300/50 m/s ²
Enclosure	Dustproof

Note 1) Based on dynamic performance test, JIS B 8419: 2010. (Coil temperature: 20°C, at rated voltage, without surge suppressor)

Note 2) Impact resistance: No malfunction occurred when it is tested with a drop tester in the axial direction and at the right angles to the main valve and armature in both energized and de-energized states every once for each condition. (Values at the initial period)

Vibration resistance: No malfunction occurred in a one-sweep test between 45 and 2000 Hz. Test was performed at both energized states in the axial direction and at the right angles to the main valve and armature. (Values at the initial period)

Solenoid Specifications

Electrical entry	Grommet (G), DIN terminal (D)	
Rated voltage (V)	AC	100, 110, 200, 220, 240
	DC	12, 24
Allowable voltage fluctuation	±10% of rated voltage	
Apparent power (AC) *	Inrush	9.5 VA/50 Hz, 8 VA/60 Hz
	Holding	7 VA/50 Hz, 5 VA/60 Hz
Power consumption (DC) *	W/o indicator light	4 W (Standard), 2 W (Low wattage)
	W/ indicator light	4.3 W (Standard), 2.3 W (Low wattage)
Surge voltage suppressor	AC	Varistor
	DC	Diode (12 VDC or less: Varistor)
Indicator light	AC	Neon bulb
	DC	LED

* At the rated voltage

Flow Rate Characteristics/Weight

Valve model	Operating pressure range (MPa)	Port size	Flow rate characteristics						Weight (g)	
			1 → 4/2 (P → A/B)			4/2 → 5/3 (A/B → R1/R2)				
			C [dm ³ /(s·bar)]	b	Cv	C [dm ³ /(s·bar)]	b	Cv		
Body ported	0 to 0.7	M5 x 0.8	0.45	0.37	0.12	0.43	0.37	0.12	90	
			1/8	0.84	0.10	0.19	0.40	0.33		0.10
		M5 x 0.8	0.38	0.30	0.09	0.40	0.34	0.10		130
			1/8	0.48	0.11	0.11	0.35	0.38		
Base mounted (with sub-plate)	0 to 0.7	1/8	0.63	0.10	0.14	0.54	0.12	0.12	130	
			0.50	0.12	0.11	0.48	0.19	0.12		

VV061

VV100

V100

S070

VQD

VQD-V

VK

VT

How to Order

Note) AC-type models that are CE/UKCA-compliant have DIN terminals only.

Rated voltage	Valve option	
	Nil	Y
1 100 VAC, 50/60 Hz	●	—
2 200 VAC, 50/60 Hz	●	—
3 110 VAC, 50/60 Hz	●	—
4 220 VAC, 50/60 Hz	●	—
5 24 VDC	●	●
6 12 VDC	●	●
7 240 VAC, 50/60 Hz	●	—

Note 1) AC-type models that are CE/UKCA-compliant have DIN terminals only.
 Note 2) For other rated voltages, please consult with SMC.



Body ported

VK3120

Base mounted

VK3140

CE/UKCA-compliant	Electrical entry			
	G: Grommet (Lead wire length: 300 mm)	H: Grommet (Lead wire length: 600 mm)	D: DIN terminal	DO*: DIN terminal (Without connector)
DC	●	●	●	●
AC	—	—	●	●

* For connector part number, refer to page 1429.

Port size (P, A and B port)

M5	M5 x 0.8
01	1/8

* R1, R2: M5

Option

Nil	None
F	With bracket (Not assembled)

Option Part No.

Description	Part no.	Note
Bracket	VK300-43-2A	With screw



Valve option

Nil	Standard
Y*	For low wattage (2 W DC)

* Applicable voltage: 12 and 24 VDC

Light/Surge voltage suppressor

Nil	None	CE/UKCA-compliant
S	With surge voltage suppressor	●
Z	With light/surge voltage suppressor (Type D only)	●

Note) AC-type models that are CE/UKCA-compliant have DIN terminals only.

* Since the indicator light is built in the connector, thus, "DOZ" is not available.

Port size

Nil	Without sub-plate
01	1/8 (With sub-plate)

Thread type

Nil	Rc
F	G
N	NPT
T	NPTF

Construction

Symbol

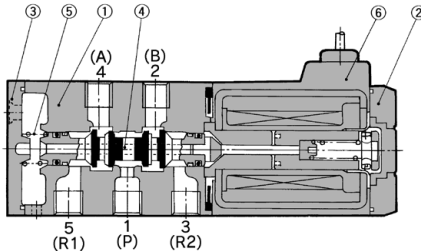
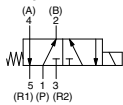

Component Parts

No.	Description	Material	Note
1	Body	Aluminum die-casted	Platinum silver
2	Cover	Resin	Black
3	End cover	Resin	Black
4	Spool valve assembly	Aluminum, NBR	
5	Return spring	Stainless steel	
6	Molded coil	Resin	Black

VK3000 Series Manifold Specifications



Specifications

Valve stations	1 to 20	
Piping method	Common SUP, Common EXH	Body ported, Base mounted
	Common SUP, Individual EXH	Body ported

Note) For 9 stations or more, supply air both sides of the R port.
The common exhaust type should exhaust from both of the R port.

Note) CE/UKCA-compliant:
For DIN terminal only



Common SUP/Common EXH

Type 20: Body ported (A, B port top ported)

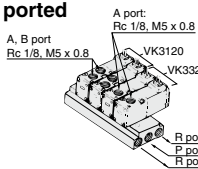

How to Order

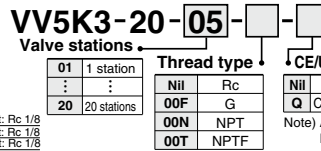

Applicable solenoid valve
VK3120□-□□□-M5(-Q)
VK3120□-□□□-01(-Q)
VK332□-□□□-M5(-Q)
VK332□-□□□-01(-Q)

Applicable blanking plate assembly
VK3000-7-1A

Type 40: Base mounted (A, B port bottom ported)

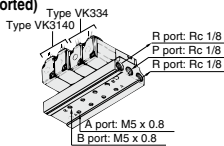

How to Order

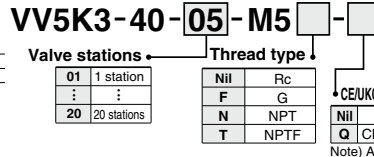

Applicable solenoid valve
VK3140□-□□□(-Q)
VK334□-□□□(-Q)

Applicable blanking plate assembly
VK3000-7-1A

Type 41: Base mounted (A, B port side ported)

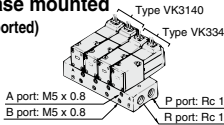

How to Order

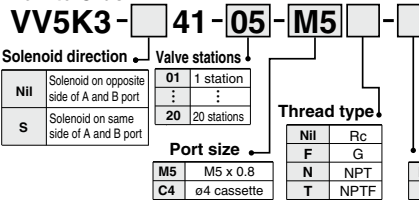

Applicable solenoid valve
VK3140□-□□□(-Q)
VK334□-□□□(-Q)

Applicable blanking plate assembly
VK3000-7-1A

Type S41

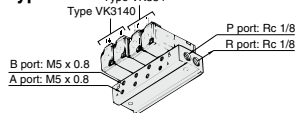

Type 42: Base mounted (A, B port side ported)

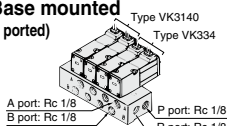

How to Order

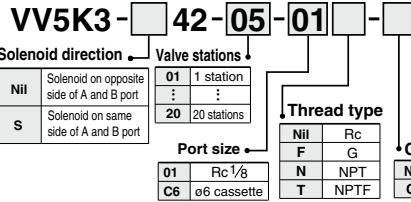

Applicable solenoid valve
VK3140□-□□□-M5(-Q)
VK334□-□□□(-Q)

Applicable blanking plate assembly
VK3000-7-1A

Type S42

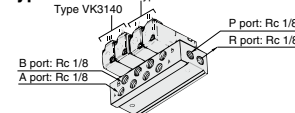

Common SUP/Common EXH

Type 21: Body ported (A, B port top ported)

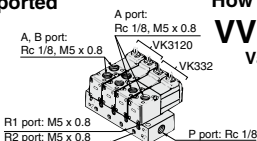

How to Order

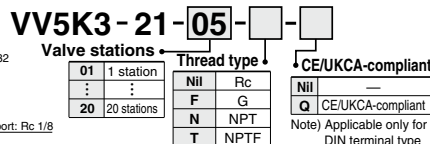

Applicable solenoid valve
VK3120□-□□□-M5(-Q)
VK3120□-□□□-01(-Q)
VK332□-□□□-M5(-Q)
VK332□-□□□-01(-Q)

Applicable blanking plate assembly
VK3000-7-1A

- VV061
- VV100
- V100
- S070
- VQD
- VQD-V
- VK
- VT

VK3000 Series

Combinations of Solenoid Valve, Manifold Gasket and Manifold Base

5 port body ported: VK3120

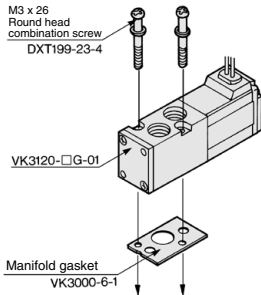

Applicable base
VV5K3-20(-Q)
VV5K3-21(-Q) } Manifold base

5 port base mounted: VK3140

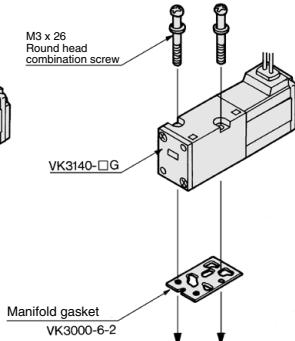

Applicable base
VK3000-9-1 Sub-plate
VV5K3-40(-Q)
VV5K3-(S)41(-Q)
VV5K3-(S)42(-Q) } Manifold base

	Body ported	Base mounted
Manifold gasket Screw assembly	VK3000-6-1A	VK3000-6-2A



Caution

Mounting Screw
Tightening Torques

M3: 0.6 N·m

Combination of Blanking Plate Assembly and Manifold Base

Blanking plate assembly: VK3000-7-1A

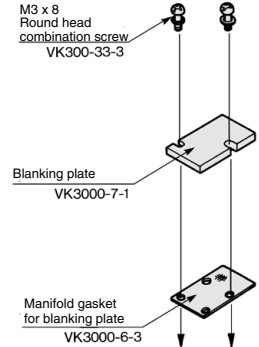

Applicable base: In common for all types
of VV5K3 (-Q) models



Caution

Mounting Screw
Tightening Torques

M3: 0.6 N·m

Note) Mounting direction is not flexible. Make sure to mount them in the right direction.

Mixed Mounting of VK300 and Manifold Base of VK3000 Series

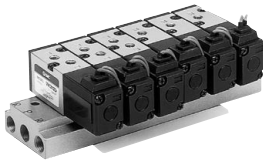

Type VV5K3-20

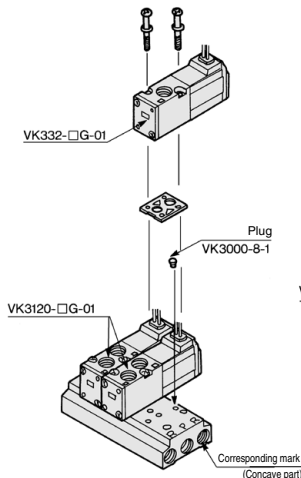

Type VV5K3-40

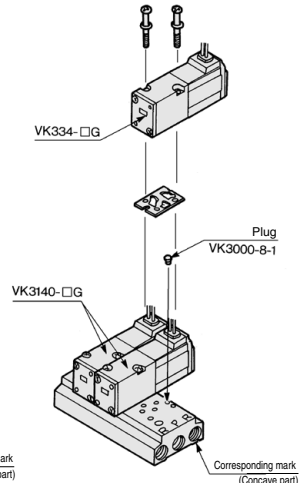

1. In the case of VV5K3-20/40

When installing the 3 port valve on the manifold base, plug the "R" port at the corresponding mark side with the rubber plug (VK3000-8-1) as shown in the figures on the right.

2. Other manifold

3 port valve can be mounted without any work.

Note 1) Remove the plug if changing the 3 port valve to a 5 port valve.

Note 2) In case a 3 port valve VK300 is mounted on the manifold base for a 5 port valve VK3000, switching type is normally closed (N.C.). If requiring a normally open type (N.O.), plug the "A" port on the 5 port valve.

Note 3) "A" port of a 3 port valve for base mounted type becomes "A" port of a 5 port valve. Plug that "A" port to avoid mistaking "B" port for the "A" port.



Caution

Mounting Screw
Tightening Torques

M3: 0.6 N·m

5 Port Solenoid Valve Direct Operated Poppet Type **VK3000 Series**

Dimensions: Body Ported

Grommet: VK3120-□G-M5
Port size: M5

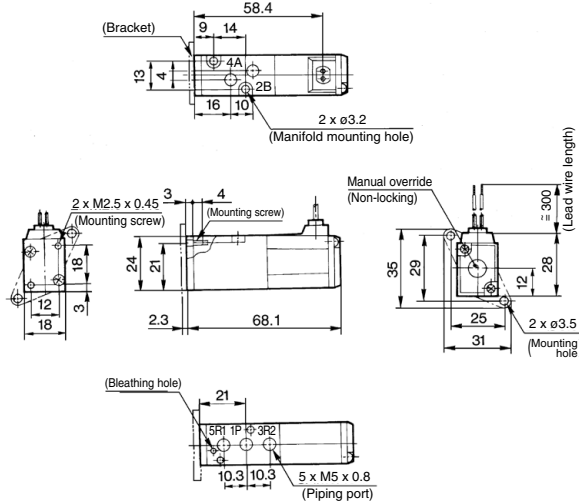

DIN terminal: VK3120-□D-M5

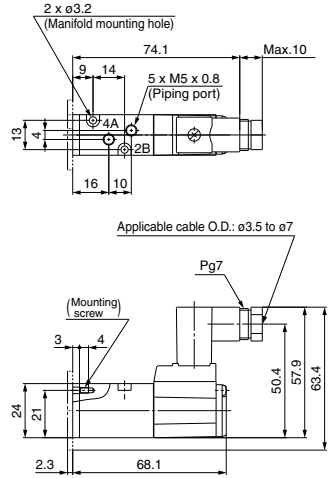

Refer to grommet type for other dimensions.

Grommet: VK3120-□G-01
Port size: Rc 1/8

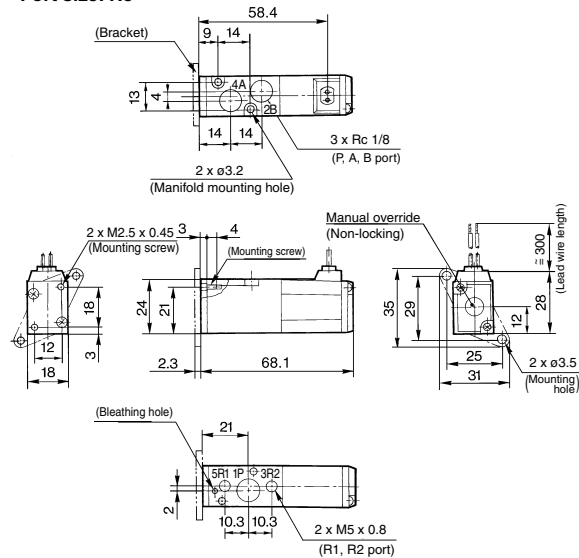

DIN terminal: VK3120-□D-01

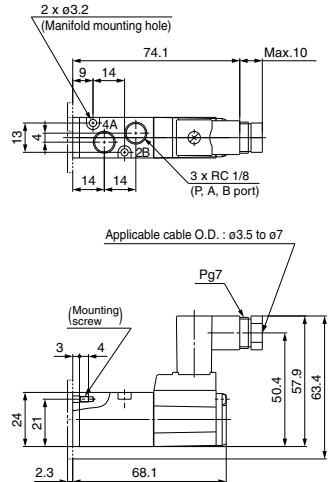

Refer to grommet type for other dimensions.

VV061
VV100
V100
S070
VQD
VQD-V
VK
VT

VK3000 Series

Dimensions: Base Mounted

Grommet: VK3140-□G-01

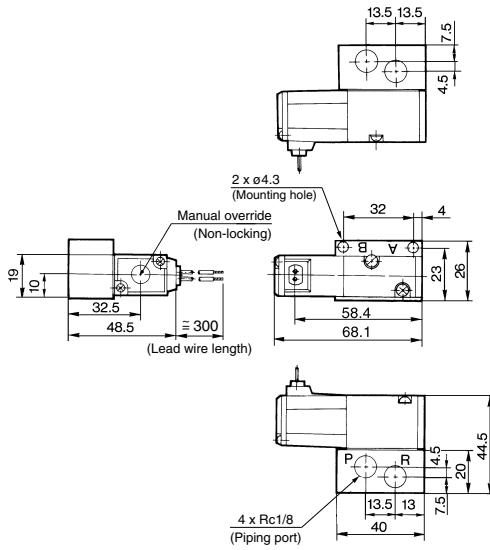

DIN terminal: VK3140-□D-01

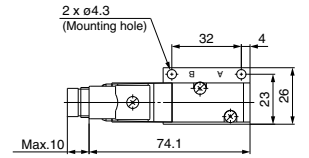

Applicable cable O.D.: $\phi 3.5$ to $\phi 7$

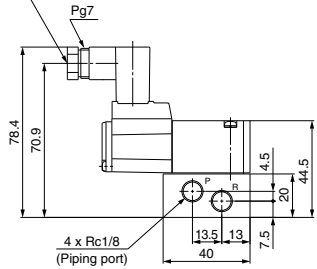

Refer to grommet type for other dimensions.

Type 20 Manifold/Body ported (Top ported)

VV5K3-20-Station

n1 = Number of VK3000
n2 = Number of VK300

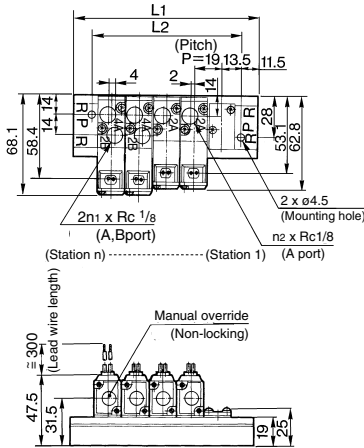

Grommet: G

DIN terminal: D

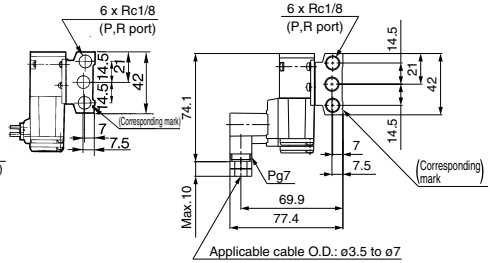

L Dimension

n: Stations

L \ n	1	2	3	4	5	6	7	8	9	10	11	12	13	14	15	16	17	18	19	20
L1	50	69	88	107	126	145	164	183	202	221	240	259	278	297	316	335	354	373	392	411
L2	27	46	65	84	103	122	141	160	179	198	217	236	255	274	293	312	331	350	369	388

Type 21 Manifold/Body ported (Top ported)

VV5K3-21-Station

Grommet: G

DIN terminal: D

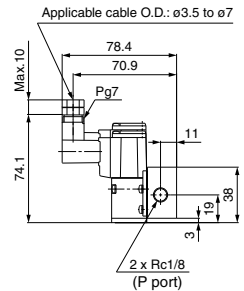
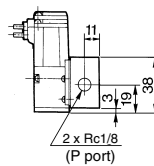
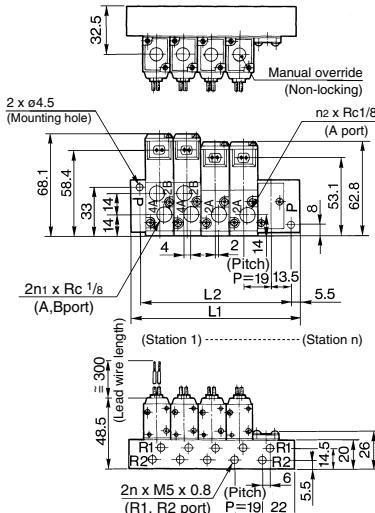

n1 = Number of VK3000
n2 = Number of VK300

L Dimension

n: Stations

L \ n	1	2	3	4	5	6	7	8	9	10	11	12	13	14	15	16	17	18	19	20
L1	38	57	76	95	114	133	152	171	190	209	228	247	266	285	304	323	342	361	380	399
L2	27	46	65	84	103	122	141	160	179	198	217	236	255	274	293	312	331	350	369	388

VV061

VV100

V100

S070

VQD

VQD-V

VK

VT

VK3000 Series

Type 40 Manifold/Base mounted (Bottom ported)

VV5K3-40-Station -M5

Grommet: G

DIN terminal: D

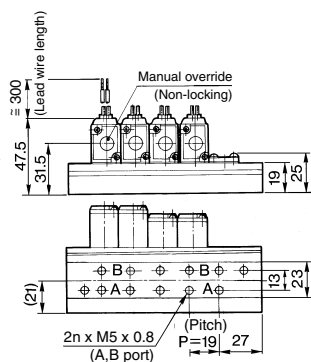
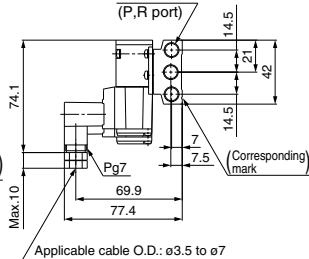
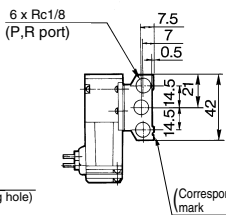
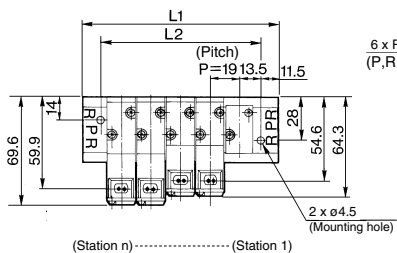

L Dimension

n: Stations

n	1	2	3	4	5	6	7	8	9	10	11	12	13	14	15	16	17	18	19	20
L ₁	50	69	88	107	126	145	164	183	202	221	240	259	278	297	316	335	354	373	392	411
L ₂	27	46	65	84	103	122	141	160	179	198	217	236	255	274	293	312	331	350	369	388

Type 41 Manifold/Base mounted (Side ported)

VV5K3-41-Station -M5

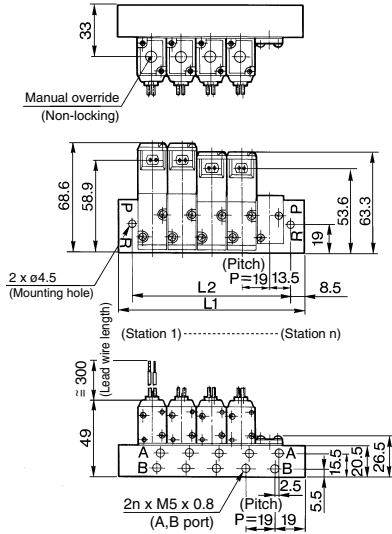

Grommet: G

DIN terminal: D

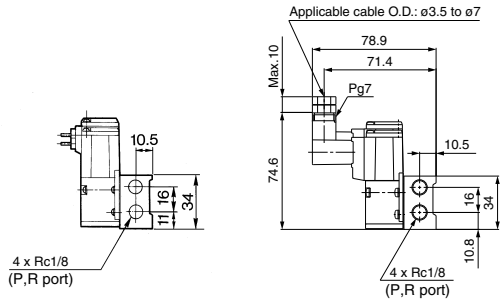

Built-in One-touch fitting: VV5K3-41-Station -C4

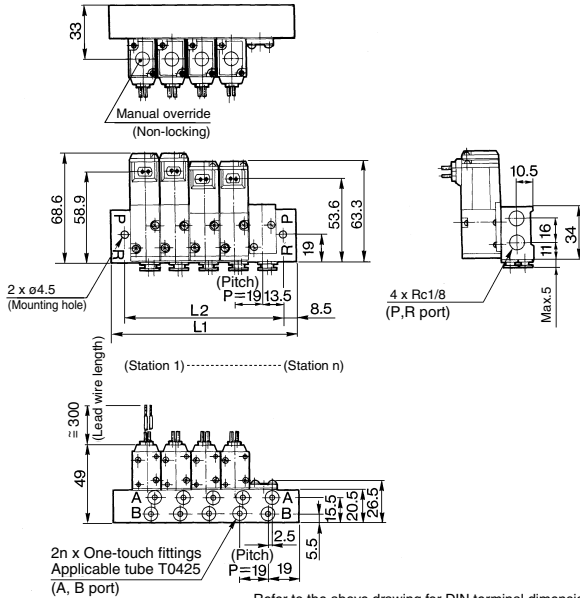

Solenoid is at the same side as A port:
VV5K3-S41-Station -□

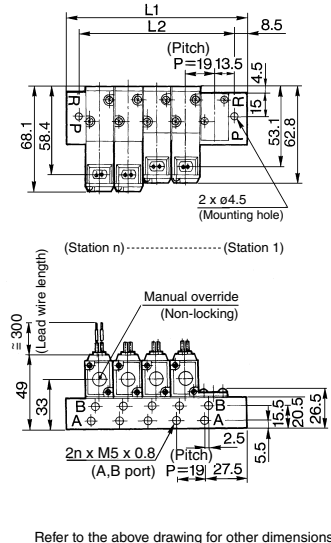

Refer to the above drawing for DIN terminal dimensions.

n	1	2	3	4	5	6	7	8	9	10	11	12	13	14	15	16	17	18	19	20
L1	44	63	82	101	120	139	158	177	196	215	234	253	272	291	310	329	348	367	386	405
L2	27	46	65	84	103	122	141	160	179	198	217	236	255	274	293	312	331	350	369	388

VV061

VV100

V100

S070

VQD

VQD-V

VK

VT

VK3000 Series

Type 42 Manifold/Base mounted (Side ported)

VV5K3-42-Station-01

Grommet: G

DIN terminal: D

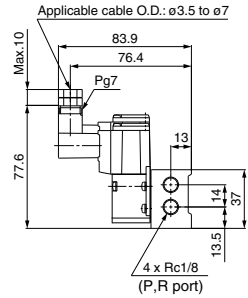
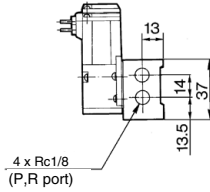
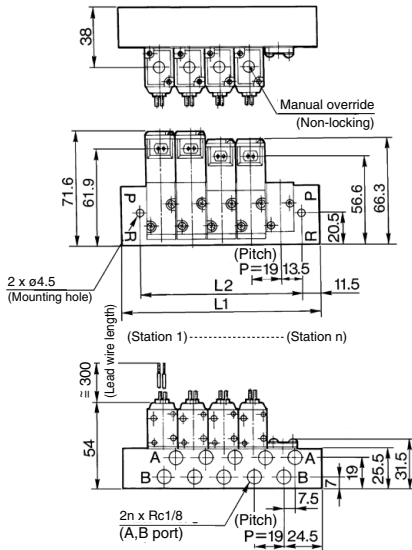

Built-in One-touch fitting: VV5K3-42-Station-C6

Solenoid is at the same side as A port:
VV5K3-S42-Station-□

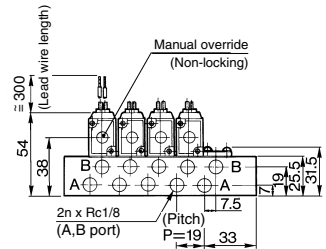
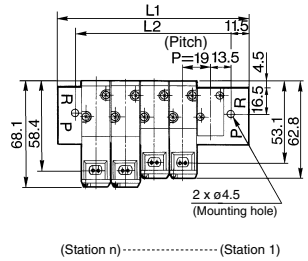
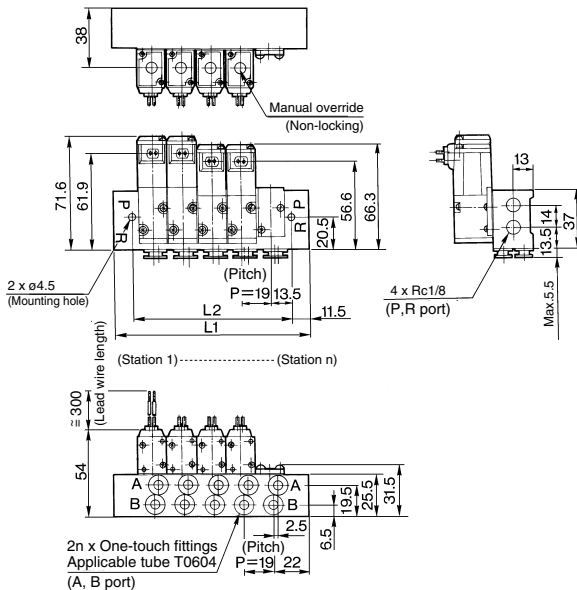

Refer to the above drawing for DIN terminal dimensions.

Refer to the above drawing for other dimensions.

n	1	2	3	4	5	6	7	8	9	10	11	12	13	14	15	16	17	18	19	20
L ₁	50	69	88	107	126	145	164	183	202	221	240	259	278	297	316	335	354	373	392	411
L ₂	27	46	65	84	103	122	141	160	179	198	217	236	255	274	293	312	331	350	369	388



VK3000 Series Specific Product Precautions

Be sure to read this before handling the products. Refer to back page 50 for Safety Instructions and pages 3 to 9 for 3/4/5 Port Solenoid Valve Precautions.

⚠ Caution

How to Wire DIN Terminal

• Connection

- Loosen the set screw and pull out the connector from the terminal block of the solenoid.
- Remove screw and insert screwdriver into the slit area near the bottom of terminal block to separate block and housing.
- Loosen the terminal screws (slotted screws) on the terminal block, insert the core of the lead wire into the terminal, and attach securely with the terminal screws.
- Tighten the ground nut to secure the cable.

⚠ Caution

Use caution in wiring because it will not meet the IP65 (enclosure) standard if you use the other cable than prescribed heavy-duty cable of size (ø3.5 to ø7). Tighten the ground nut and set screw within the specified range of torque.

• Change of electrical entry (Orientation)

After separating terminal block and housing, the cable entry direction can be changed by attaching the housing in the desired direction (4 directions in 90 increments).

* In the case of w/indicator light, avoid damaging the light with lead wire.

• Precautions

Plug a connector in or out vertically, never at an angle.

• Applicable cable

O.D. ø3.5 to ø7
(Reference)
0.5 mm² 2 core and 3 core wires
equivalent to JIS C 3306

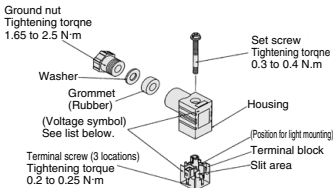

● Connector part no.: VK300-82-1

● Part no. of connector with light

Rated voltage	Voltage symbol	Part no.
100 VAC	100V	VK300-82-2-01
110 VAC	110V	VK300-82-2-03
200 VAC	200V	VK300-82-2-02
220 VAC	220V	VK300-82-2-04
240 VAC	240V	VK300-82-2-07
6 VDC	6V	VK300-82-4-51
12 VDC	12V	VK300-82-4-06
24 VDC	24V	VK300-82-3-05
48 VDC	48V	VK300-82-3-53

● Circuit with light

AC Circuit diagram 12 VDC or less Circuit diagram 24 VDC or more Circuit diagram

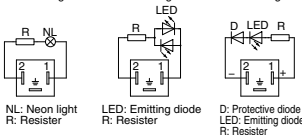

⚠ Caution

Light/Surge Voltage Suppressor

Rated voltage	Grommet type (G)	DIN terminal (D)	Part no. symbol
AC	Varistor	No.1 No.2	S
		None	Z
24 V 48 V	Diode	No.1(+) No.2(-)	S
		None	Z
6 V 12 V	Varistor	No.1 No.2	S
		None	Z

Precautions on connection for 24 VDC or more

Grommet type should be connected as following; Red lead wire for (+) side, Black lead wire for (-) side respectively.

With the DIN terminal, connect the positive (+) side to the connector's no. 1 terminal, and the negative (-) side to the no. 2 terminal. [Refer to the marks on the terminal board.]

* For 12 VDC or below, there is no positive (+) or negative (-) directionality.

• Grommet type

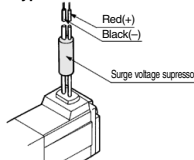

• DIN terminal

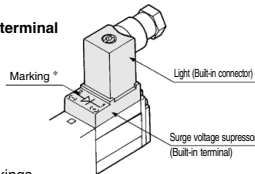

* Markings

For AC, 12 VDC or less

For 24 VDC or more

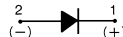

⚠ Warning

Valve Mounting Direction

When mounting a valve or spacer on the manifold base or sub-plate, etc., those mounting directions are determined. If mounted in the wrong direction, the equipment to be connected may cause malfunction. Refer to external dimensions in pages 1423 to 1428, and then mount it.

How to Calculate the Flow Rate

For obtaining the flow rate, refer to front matter.

VV061

VV100

V100

S070

VQD

VQD-V

VK

VT