

# 3 Port Solenoid Valve Pilot Operated Poppet Type VG342 Series

Rubber Seal



(Option)  
Note) CE/UKCA-compliant:  
For DIN terminal only

## Low power consumption

4 W DC (Standard type)  
1.8 W DC (Energy-saving type)

## No lubrication required

## Possible to use in vacuum or under low pressures

External pilot  
Vacuum: Up to  $-101.2$  kPa  
Low pressure: 0 to 0.2 MPa

## Changeable actuation: N.C., N.O., or external pilot

## Can be used as a selector or divider valve (External pilot)

### External Pilot

Use external pilot type in the following cases:

- For vacuum or for low pressure 0.2 MPa or less
- When having P port downsized in diameter
- When using A port as the atmospheric releasing port, e.g. air blower



### Symbol

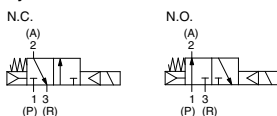

### External pilot

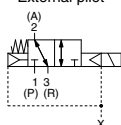

## How to Order

VG342  - 1 G  - 04  A -  -

### Valve type

Nil	Internal pilot
R	External pilot

### Rated voltage

1	100 VAC, 50/60 Hz
2	200 VAC, 50/60 Hz
3	110 VAC, 50/60 Hz
4	220 VAC, 50/60 Hz
5	24 VDC
6	12 VDC
7	240 VAC, 50/60 Hz

### Electrical entry

G	Grommet	CE/UKCA-compliant	—
D	DIN terminal	—	●

### Light/Surge voltage suppressor

Nil	None
S	With surge voltage suppressor (Only grommet type is only available.)
Z	With light/surge voltage suppressor (Except grommet type)

### CE/UKCA-compliant

Nil	—
Q	CE/UKCA-compliant (Note)

Note) Applicable only for DIN terminal type

### Pilot valve option

Nil	Standard type
Y	Energy-saving type (DC only)
E	Continuous duty type

### Passage symbol

Nil	External pilot
A	N.C. (Normally closed)
B	N.O. (Normally open)

### Thread type

Nil	Rc
F	G
N	NPT
T	NPTF

### Port size

04	1/2
06	3/4
10	1

## How to Order Pilot Valve Assembly

VO307  - 1 G  1 - X84 -

### Pilot valve option

Nil	Standard type
Y	Energy-saving type (DC only)
E	Continuous duty type

### Rated voltage

1	100 VAC, 50/60 Hz
2	200 VAC, 50/60 Hz
3	110 VAC, 50/60 Hz
4	220 VAC, 50/60 Hz
5	24 VDC
6	12 VDC
7	240 VAC, 50/60 Hz

### CE/UKCA-compliant

Nil	—
Q	CE/UKCA-compliant (Note)

Note) Applicable only for DIN terminal type

### Pilot valve assembly for VG342

### Light/Surge voltage suppressor

Nil	None
S	With surge voltage suppressor (Only grommet type is available.)
Z	With light/surge voltage suppressor (Except grommet type)

### Electrical entry

G	Grommet	CE/UKCA-compliant	—
D	DIN terminal	—	●

# VG342 Series

## ⚠ Caution

### Light/Surge Voltage Suppressor

#### AC, 100 V or more

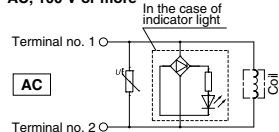

#### 48 VDC or less

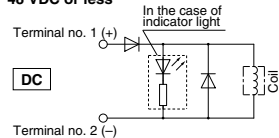

### Electrical Connection

In the case of DIN terminal (with light/surge voltage suppressor), the connection is as follows. Connect each to the power supply side.

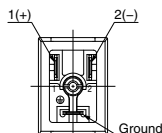

### How to Change Passage State

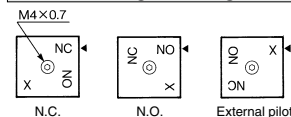

When changing the passage state, confirm that pressure has been removed from the valve.

Unscrew the M4 x 0.7 hexagon socket head cap screw in the changeover plate and match the ◀ mark on the adapter plate with the character on the changeover plate. Piping is as follows.

### Mounting Screw Tightening Torques

M4: 1.4 N·m

### Piping

Passage	Port	P	A	R
N.C.		Inlet	Outlet	Exhaust side (Plug, in case of 2 port valve)
N.O.		Exhaust side (Plug, in case of 2 port valve)	Outlet	Inlet
External		Universal porting (Piping of inlet pressure side is possible anywhere)		

Note 1) In the case of internal pilot, confirm that a plug is inserted to X port. If not, insert a R 1/8 plug.

Note 2) In the case of external pilot, supply air pressure from X port.

Confirm the safety sufficiently and conduct carefully when changing the passage state or restarting after changes.

## Specifications

Type of actuation	In common between N.C. and N.O.	
Fluid	Air	
Operation	Internal pilot type	External pilot type
Operating pressure range	0.2 to 0.9 MPa	-101.2 kPa to 0.9 MPa
External pilot operating pressure range	—	Same as the operating pressure (Min. 0.2 MPa)
Response time <sup>(1)</sup>	30 ms or less (at the pressure of 0.5 MPa)	
Max. operating frequency	5 c/s (Min. operating frequency: 1 c/30 days based on JIS B 8374-1981)	
Ambient and fluid temperature	-10 to 50°C (No freezing)	
Lubrication	Not required (Use turbine oil Class 1 ISO VG32, if lubricated.)	
Manual override	Push type (Non-locking)	
Mounting orientation	Unrestricted	
Impact/Vibration resistance (m/s <sup>2</sup> ) <sup>(2)</sup>	150/50	
Weight	1.0 kg	

Note 1) Based on dynamic performance test JIS B 8419: 2010. (Coil temperature 20°C, at rated voltage, without surge voltage suppressor)

Note 2) Impact resistance: No malfunction occurred when it is tested with a drop tester in the axial direction and at the right angles to the main valve and armature in both energized and de-energized states every once for each condition. (Values at the initial period)

Vibration resistance: No malfunction occurred in a one-sweep test between 45 and 1000 Hz. Test was performed at both energized and de-energized states in the axial direction and at the right angles to the main valve and armature. (Values at the initial period)

## Flow Rate Characteristics

Port size	Flow rate characteristics											
	1 → 2 (P → A)		2 → 3 (A → R)		2 → 1 (A → P)		3 → 2 (R → A)					
	C (dm <sup>3</sup> /s/bar)	b	Cv	C (dm <sup>3</sup> /s/bar)	b	Cv	C (dm <sup>3</sup> /s/bar)	b	Cv	C (dm <sup>3</sup> /s/bar)	b	Cv
1/2	26	0.38	7.0	27	0.37	7.4	27	0.36	7.3	25	0.37	6.8
3/4	38	0.30	9.8	38	0.32	9.8	40	0.22	9.8	40	0.20	9.6

Port size	Effective area (mm <sup>2</sup> )	
	1 → 2 (P → A)	2 → 3 (A → R)
1	210	235

## Pilot Valve Assembly Specifications

Electrical entry	Grommet (G), DIN terminal (D)	
Lead wire color	100 VAC: Blue, 200 VAC: Red, 24 VDC: Red/Black	
Enclosure	Dusttight	
Coil rated voltage (V)	AC (50/60 Hz)	100, 200, 110, 220, 240
	DC	24, 12
Allowable voltage fluctuation	-15 to +10% of rated voltage	
Apparent power VA (Hz)	AC	Inrush Holding 12.7 (50), 10.7 (60) 7.6 (50), 5.4 (60)
Power consumption	DC	Without indicator light: 4 W With indicator light: 4.2 W

## Energy-saving type: VG342□-□□□-□□□-Y (-Q)

Use "Energy-saving type" if low power consumption is required for electronic control.  
\* DC only

Specifications different from standard are as follows.

Power consumption	DC	Without indicator light: 1.8 W With indicator light: 2 W
-------------------	----	---

## Continuous duty type: VG342□-□□□-□□□-E (-Q)

Use "Continuous duty type" if energizing the valve for a long time.

Specifications different from standard are as follows.

Apparent power VA (Hz)	AC	Inrush Holding 7.9 (50), 6.2 (60) 5.8 (50), 3.5 (60)
Power consumption	DC	Without indicator light: 1.8 W With indicator light: 2 W

## DIN Connector part number

Standard	B1B09-2A
CE/UKCA-compliant	GM209NJ-B17



# VG342 Series

## Dimensions

### Grommet (G)

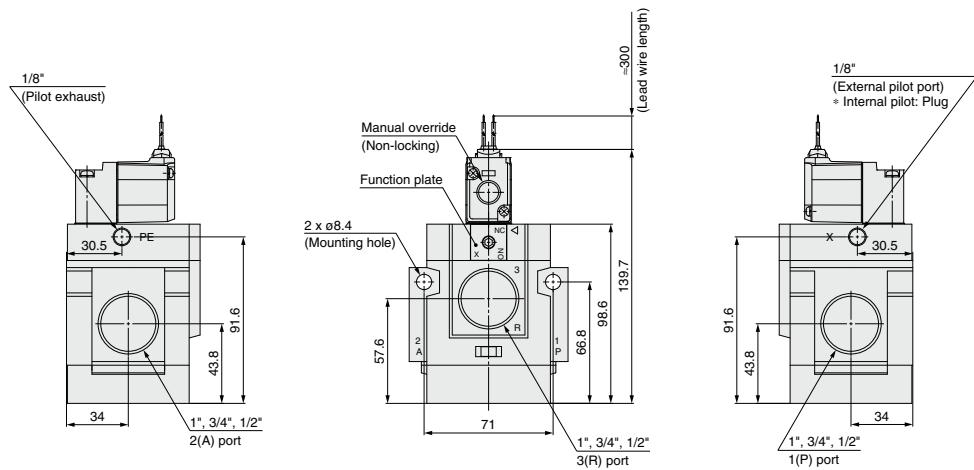
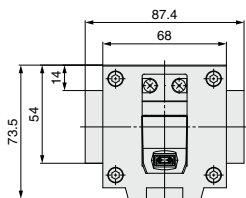

# 3 Port Solenoid Valve Pilot Operated Poppet Type **VG342 Series**

## Dimensions

### DIN terminal (D)

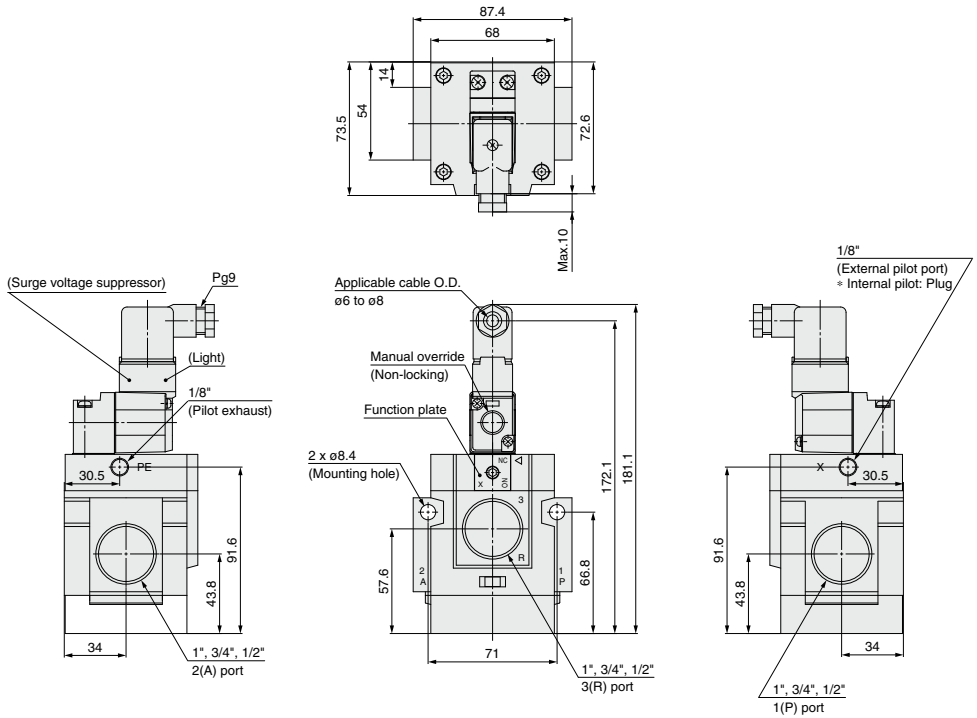

SYJ

VQZ

VP

VG

VP3