

Air-blow Module

LLB1 Series (Produced upon receipt of order)

Reduced piping man-hours/space-saving
 Integration of devices in compact space
 Parts in contact with fluid: Grease-free

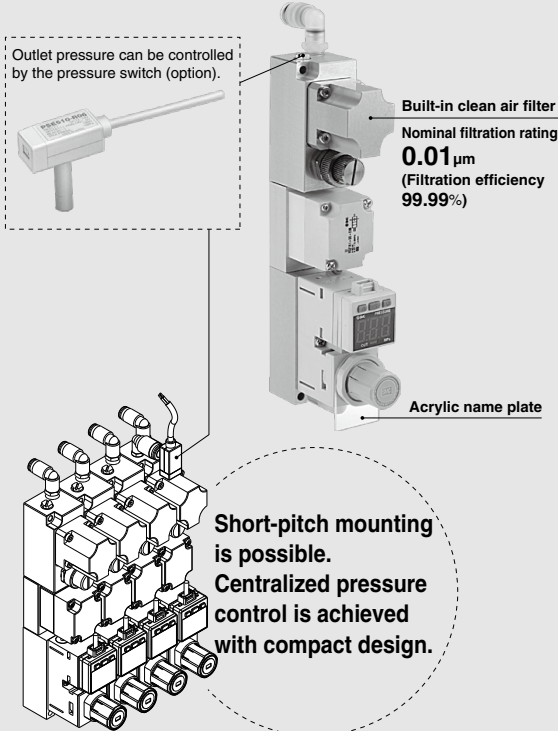

Available in 3 patterns.

Variations

Regulator + (Digital pressure switch)	ON/OFF valve	Restrictor + Filter + Pressure switch
—	—	●
—	●	●
●	●	●

Regulator + Digital pressure switch + ON/OFF valve + Restrictor + Filter

ON/OFF valve + Restrictor + Filter

Restrictor + Filter

Applications

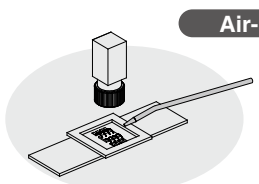

Air-blow

N₂ blow to prevent lead frame oxidation.
 N₂ blow to prevent detection camera blur.

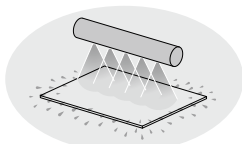

Prevents traces of water droplets.
 Air-knife

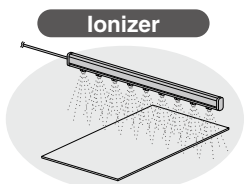

Ionizer

Supplies main pressure to the ionizer.

- HAA
- HAW
- AT
- IDF
- IDU
- IDF
- FS
- IDFA
- IDFB
- IDH
- ID
- IDG
- IDK
- AMG
- AFF
- AM
- AMD
- AMH
- AME
- AMF
- ZFC
- SF
- SFD
- LLB**
- AD
- GD

Air-blow Module

LLB1 Series

(Produced upon receipt of order)

How to Order

LLB1 - C4 - [] - [] - [] - F - X1

Fitting size

C4	ø4 One-touch fitting
C6	ø6 One-touch fitting

Fitting type

Nil	Straight
L	Elbow

Regulator

Nil	Without regulator
R	Without pressure gauge
RN	Digital pressure switch, NPN open collector
RP	Digital pressure switch, PNP open collector
RG	With pressure gauge

Restrictor + Filter

F	Without pressure switch
F1	With pressure switch

* Used to check the differential pressure of the clean filter, etc.

ON/OFF valve

Nil	Without 2 port solenoid valve
V5	24 VDC/2.9 W
V5E	24 VDC/1.8 W
V6	12 VDC/2.9 W

Set pressure range ^{Note 1)}

Nil	0.05 to 0.6 MPa specification (standard)
5	0.05 to 0.35 MPa specification ^{Note 2)}

Note 1) There is no need to enter the symbol, when "without regulator" is selected.
Note 2) A pressure gauge with a full span of 0.4 MPa is provided.

Variations

Regulator + (Digital pressure switch)	ON/OFF valve	Restrictor + Filter + Pressure switch	Weight (g)
			254
—	●	●	356
●	●	●	565

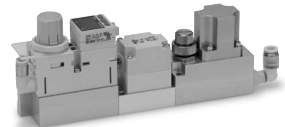

Regulator + Digital pressure switch +
ON/OFF valve + Restrictor + Filter



ON/OFF valve + Restrictor + Filter



Restrictor + Filter

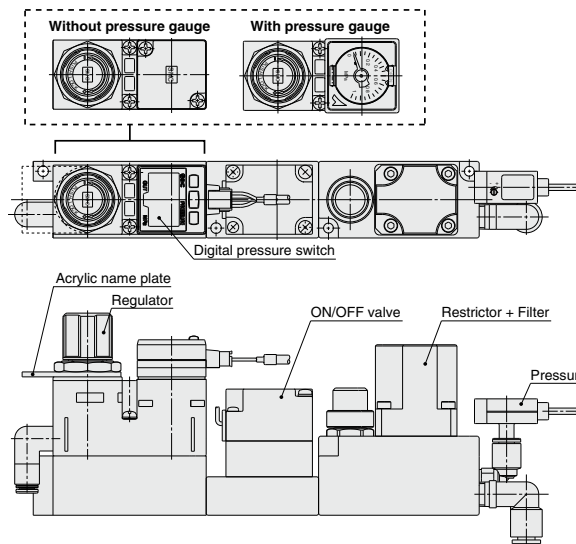

Specifications

Air-blow Module Common Specifications

Fluid		Air, N ₂ gas
Maximum operating pressure		0.7 MPa
Set pressure range		0.05 to 0.6 MPa (0.05 to 0.35 MPa) ^{Note 3)}
Withstand pressure		1.0 MPa
Fluid temperature		5 to 45°C (No freezing)
Ambient temperature		
Flow range ^{Note 1)}		Up to 100 L/min (ANR)
Nominal filtration rating ^{Note 2)}		0.01 μm (Filtration efficiency 99.99%)
Fluid contact space material	Body	AL
	Bushing	AL
	Seal	HNBR
Fitting material	Straight ø4	POM, Stainless steel, PBT, NBR (Fluorine coated)
	Straight ø6	POM, Stainless steel, Brass (Electroless nickel plated), NBR (Fluorine coated)
	Elbow	POM, Stainless steel, Brass (Electroless nickel plated), PBT, NBR (Fluorine coated)
Applicable tubing material		PFA, Polyolefin, Soft polyolefin, Polyurethane ^{Note 4)}

Note 1) The maximum flow rate varies depending on set pressure. Refer to "Flow Rate Characteristics" for detail.

Note 2) According to SMC measurement conditions.

Note 3) The upper limit value of the set pressure range of each product number can be changed.

Note 4) Due to the softness of polyurethane tubing, it may fold when being inserted.

Hold the end of the tubing and insert it all the way in.

Regulator Unit Specifications

Regulator type		Direct acting
Relief mechanism		Relief type
Pressure gauge specifications	Display accuracy	±3%F.S. (Full Span)
	Calibration angle	230°
	Limit indicator	With limit indicator
Fluid contact space material	Body, Port plug	PBT
	Valve seat, Stem	POM
	Diaphragm	Weatherproof NBR
	Valve	Aluminum alloy (chromate), HNBR
	Valve spring	Stainless steel
	O-ring	HNBR
	Without pressure display	POM, HNBR
	With pressure gauge	Brass, HNBR
	Digital pressure switch	PPS, Silicone, HNBR

HAA
HAW

AT

IDF
IDU

IDF
FS

IDFA

IDFB

IDH

ID

IDG

IDK

AMG

AFF

AM

AMD

AMH

AME

AMF

ZFC

SF

SFD

LLB

AD

GD

Specifications

ON/OFF Valve Unit Specifications

Valve type		2 port poppet pilot operated
Ambient and fluid temperature		-10 to 50 ^{Note 1)}
Impact resistance/Vibration resistance		150/30 m/s ² ^{Note 2)}
Internal leakage cm ³ /min		15 or less
Exterior leakage cm ³ /min		15 or less
Mounting orientation		Free
Coil rated voltage		12 VDC, 24 VDC
Allowable voltage fluctuation		±10% rated voltage
Type of coil insulation		Equivalent to B type
Power consumption	V5, V6	Inrush: 2.9 W Holding: 0.6 W
	V5E	1.8 W
Electrical entry		Grommet
Flow rate characteristics	C [dm ³ /(s·bar)]	V5,V6: 1.4, V5E: 0.71
	b	V5,V6: 0.23, V5E: 0.25
	Cv	V5,V6: 0.33, V5E: 0.17
Minimum operating pressure differential		0.01 MPa ^{Note 3)}
Maximum operating pressure		0.6 MPa
Response time ^{Note 4)}	ON	10 ms or less (with power-saving circuit)
	OFF	15 ms or less (with power-saving circuit)
Fluid contact space material	Body	PBT
	Diaphragm	HNBR
	Armature/Fixed armature	Stainless steel

Note 1) Use dry air to prevent condensation when operating at low temperatures.

Note 2) Vibration resistance: No malfunction occurred in a one-sweep test between 8.3 and 2000 Hz. Test was performed at both energized and de-energized states to the axis and right angle directions of the main valve and armature (value at the initial state).

Impact resistance: No malfunction resulted from the impact test using a drop impact tester. The test was performed on the axis and right angle directions of the main valve and armature for both energized and de-energized states (value at the initial state).

Note 3) If a restrictor (nozzle, etc.) is mounted on the outlet side piping, the pressure differential when ON is smaller. Be sure that the pressure differential does not drop below 0.01 MPa.

Note 4) JIS 8375 (At supply pressure 0.5 MPa)

(Value of high response time is subject to change upon pressure, quality of air.)

Restrictor Unit Specifications

Cv factor	0.28
Number of needle rotations	8 rotations
Fluid contact space material	Stainless steel

Filter Unit Specifications

Nominal filtration rating ^{Note 1)}		0.01 μm (Filtration efficiency 99.99%)
Element withstand differential pressure ^{Note 2)}		0.5 MPa
Flow capacity		Up to 100 L/min (ANR)
Fluid contact space material	Filter case	PC, ABS
	Hollow fiber	PP, PET
	Potting	PU
	O-ring	FKM

Note 1) According to SMC measurement conditions.

Note 2) This means that the element does not break at 0.5 MPa. Refer to "Specific Product Precautions".

Component Parts

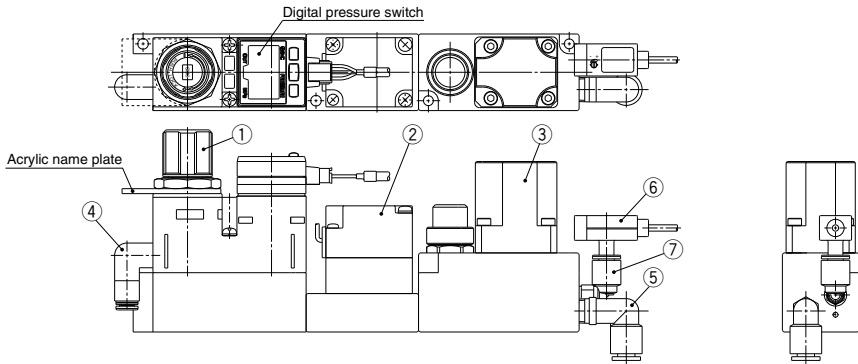

No.	Description	Individual part no.	Note	
1	Regulator assembly	Without pressure gauge	LVB1-1	
		Digital pressure switch NPN open collector	LVB1-2-1	For set pressure range 0 to 0.35 MPa LVB1-2-2
		Digital pressure switch PNP open collector	LVB1-3-1	For set pressure range 0 to 0.35 MPa LVB1-3-2
		With pressure gauge	LVB1-4-1	For set pressure range 0 to 0.35 MPa LVB1-4-2
2	ON/OFF valve	Acrylic name plate	136163-2	
		12 VDC	LVB1-5-1	
		24 VDC (2.9 W)	LVB1-5-2	
		24 VDC (1.8 W)	LVB1-5-3	
3	Regulator clean air filter assembly	LVB1-6		
4	In side One-touch fitting assembly	Replacement element	SFD-EL101	
		Straight	ø4	VVQ1000-50A-C4-X17
			ø6	VVQ1000-50A-C6-X17
		Elbow	ø4	VVQ1000-50A-L1C4-X17
ø6	VVQ1000-50A-L1C6-X17			
5	Out side One-touch fitting assembly	Straight	ø4	KPH04-01
			ø6	KPH06-01
		Elbow	ø4	KPL04-01
			ø6	KPL06-01
6	Pressure switch	PSE510-R06		
7	Fitting for pressure switch	KPGL06-M5-X193		

Flow Rate Characteristics Note) The flow rate characteristics are representative values.

Relationship between number of needle rotations and flow rate

Conditions ① ø6 pipe length
 In side = 600 mm
 Out side = 100 mm
 Measured under the conditions shown above.
 ② Measured in the regulator full open status.

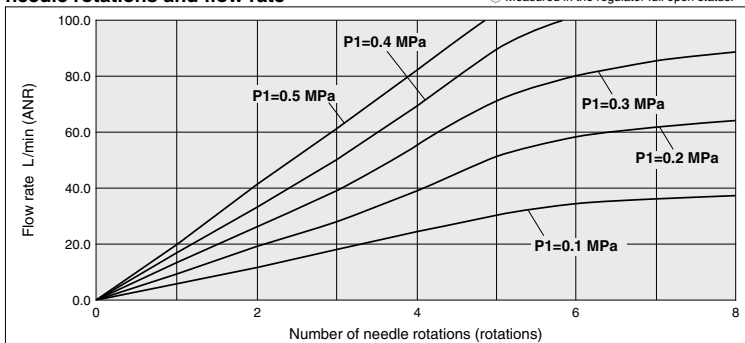

- HAA
- HAW
- AT
- IDF
- IDU
- IDF
- FS
- IDFA
- IDFB
- IDH
- ID
- IDG
- IDK
- AMG
- AFF
- AM
- AMD
- AMH
- AME
- AMF
- ZFC
- SF
- SFD
- LLB
- AD
- GD

LLB1 Series

Dimensions

LLB1-C₄^{C₆}□-F(1)-X1

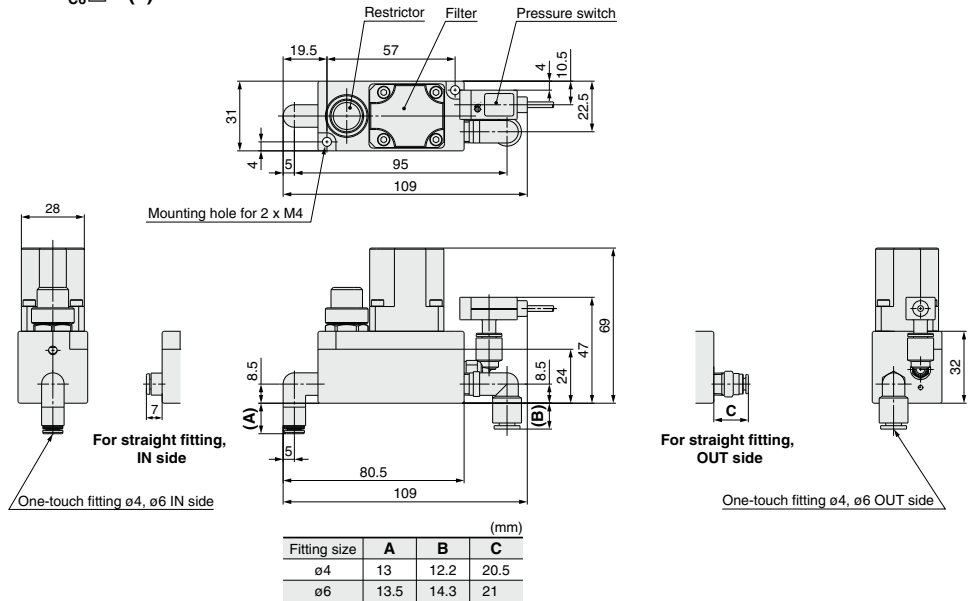

LLB1-C₄^{C₆}□-V₆⁵F(1)-X1

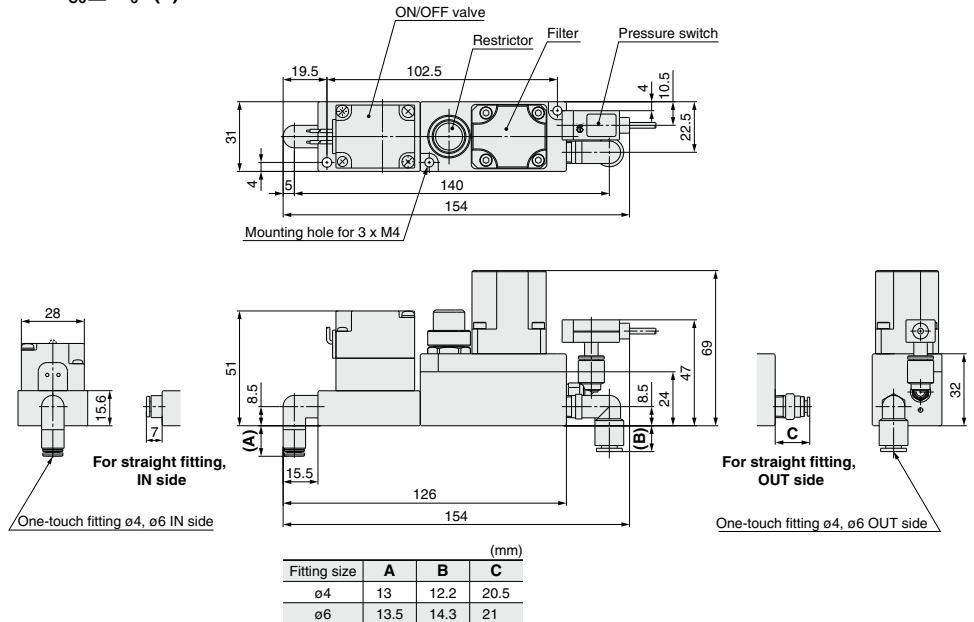

Dimensions

LLB1-C⁴□-R^N□V⁵F(1)-X1

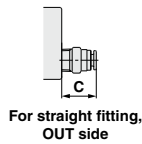
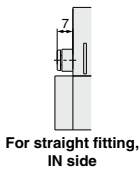
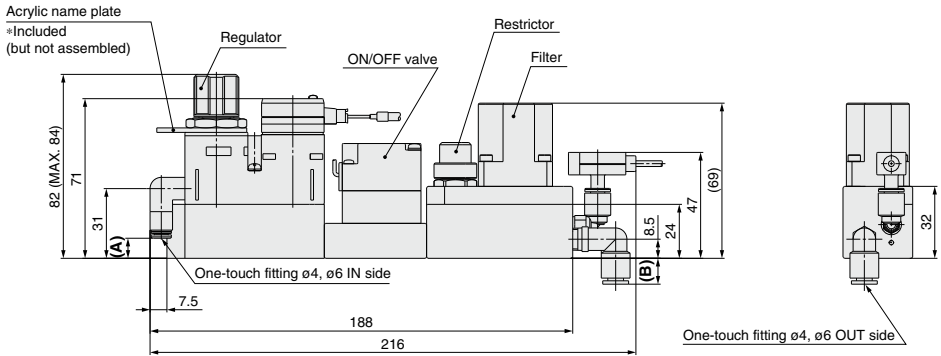
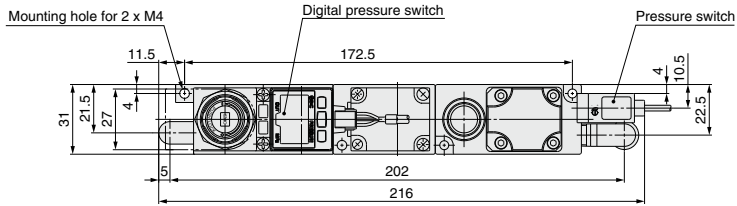

(mm)

Fitting size	A	B	C
ø4	9.5	12.2	20.5
ø6	9	14.3	21

- HAA
- HAW
- AT
- IDF
- IDU
- IDF
- FS
- IDFA
- IDFB
- IDH
- ID
- IDG
- IDK
- AMG
- AFF
- AM
- AMD
- AMH
- AME
- AMF
- ZFC
- SF
- SFD
- LLB**
- AD□
- GD

Digital pressure switch

Specifications

Rated pressure range	0 to 1 MPa
Set pressure range	- 0.1 to 1 MPa
Withstand pressure	1.5 MPa
Set pressure resolution	0.01 MPa
Power supply voltage	12 to 24 VDC, Ripple (p-p) $\pm 10\%$ or less (with power supply polarity protection)
Current consumption	55 mA or less (at no load)
Switch output	NPN or PNP open collector 1 output
Maximum load current	80 mA
Maximum applied voltage	30 V (at NPN output)
Residual voltage	1 V or less (with load current of 80 mA)
Response time	1s
Anti-chattering function	(0.25, 0.5, 2, 3)
Short circuit protection	With short-circuit protection
Repeatability	$\pm 1\%$ F.S. or less
Hysteresis	Variable (0 or above)
Hysteresis mode	
Window comparator mode	
Display	3-digit, 7-segment indicator, 2-color display (Red/Green) can be interlocked with the switch output
Display accuracy	$\pm 2\%$ F.S. ± 1 digit (at 25°C $\pm 3^\circ$ C)
Indicator light	OUT: Lights up when output is turned ON (Green)
Environmental resistance	Enclosure IP40
Lead wire with connector	$\phi 3.4$ 3 cores 25AWG 2 m

Output specifications

NPN open collector output

Max. 30 V, 80 mA
Residual voltage: 1 V or less

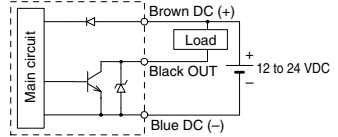

PNP open collector

Max. 80 mA
Residual voltage: 1 V or less

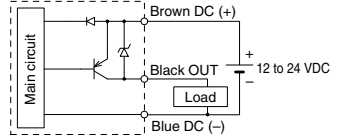

Model

ISE35 - N - 25 - M - X501

Electrical entry specifications

N: Wiring bottom entry R: Wiring top entry

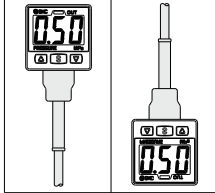

Semi-standard specifications

Symbol	Contents
NII	None
X501	Oil-free

Option 2

Symbol	Contents
NII	Switch body only
B ^(Note)	With mounting option

(Note) Adapter, O-ring, and lock pin mounting screws (2 pcs.) are included.

Option 1

Symbol	Contents
NII	Without lead wire with connector
L	With lead wire with connector (2 m)

Output specifications

Symbol	Contents
25	NPN output
65	PNP output

Unit specifications

Symbol	Contents
M	Fixed SI unit

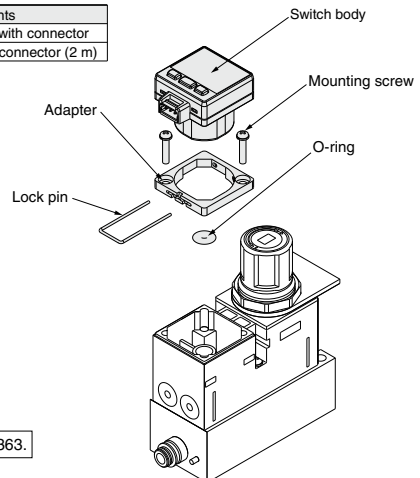
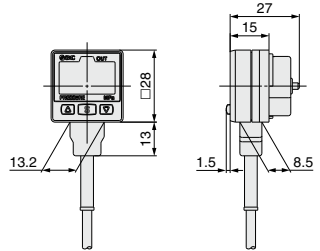

For details about setting and operating procedures, refer to pages 359 to 363.

Pressure Setting

Operation

When the pressure level exceeds the set value, the switch turns ON.

When the pressure level decreases only the hysteresis from the set value, the switch turns OFF.

With the factory default settings, when the pressure level exceeds 0.35 MPa, the switch turns ON. When the pressure level becomes 0.34 MPa or less, the switch turns OFF.

When the operation shown in the Fig. below has no problem, use the product with the factory default settings.

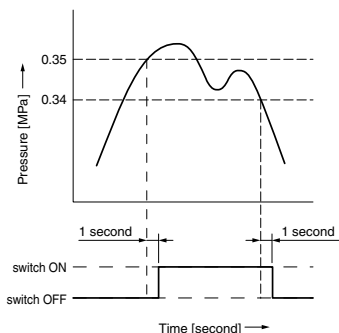

<Operating procedure>

- 1 Press the **[S]** button in the measurement mode to display the set value.

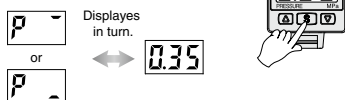

- 2 Press the **[Δ]** or **[▽]** button to change the set value. Pressing the **[Δ]** button will increase the set value while pressing the **[▽]** button will decrease the set value.
 - Press the **[Δ]** button once to increase the numeric value. Keep the **[Δ]** button pressed to continuously increase the numeric value.

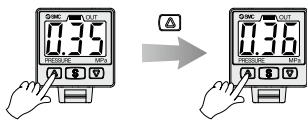

- Press the **[▽]** button once to decrease the numeric value. Keep the **[▽]** button pressed to continuously decrease the numeric value.

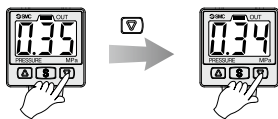

- 3 Press the **[S]** button to complete the setting.

For details about how to set the pressure in window comparator mode, refer to "Pressure Setting (Window comparator mode)" on page 361.

Function Settings

Factory default settings

The factory default settings are as follows.

When there is no problem with the factory default settings, use the product as it is. To change any setting, make the setting properly while referring to relevant page.

Setting item	Factory default settings
Switch output Whether or not the switch output is used can be selected. The product can be used as pressure gauge without using the switch output. Switch output → P.360	ON
Display color The display color can be selected. Display color → P.360	ON: Green OFF: Red
Response time When the response time is set, this prevents chattering output. Response time → P.360	1s
Operation mode The switch operation mode can be selected. Operation mode → P.360	Hysteresis mode
Hysteresis Hysteresis → P.361	0.01 MPa (1psi)

The numeric value in () shows the value when the unit specifications are P.

Setting item	Factory default settings
Output mode The switch output mode can be set. Output modes → P.361	Normally Open
Power-saving mode Power-saving mode can be selected. Power-saving mode → P.361	OFF
Security code setting It can be set whether code number input is required or not when key is locked Security code setting → P.362	OFF

Special function settings

Setting item	
Flip display mode The display can be flipped vertically. Display mode → P.362	

Handling precautions

- When changing the factory default settings, the setting item is changed with the **[S]** button. Be sure to check that the item you want to change is displayed, and then make the setting without fail.

About measurement mode

In this measurement mode, the pressure is detected and displayed or the switch is operated after the power has been turned ON. The measurement mode is a basic mode that allows you to change the setting or set other functions according to the purpose.

Turn ON the power.

The display that shows the unit specifications is lit for approx. 1 second.

Unit specifications: M S-U	Unit specifications: P S-U	Unit specifications: Nil S-F
--------------------------------------	--------------------------------------	--

The operation enters the measurement mode and the current pressure value is displayed.



HAA
HAW
AT
IDF
IDU
IDF
IFS
IDFA
IDFB
IDH
ID
IDG
IDK
AMG
AFF
AM
AMD
AMH
AME
AMF
ZFC
SF
SFD
LLB
AD
GD

Function Settings

1. Switch output (S_U)

Whether or not the switch output is used can be selected. When it is selected that the switch output is not used, the product can be used as a pressure gauge without using the switch output. In this case, only the display color changes as it interlocks with changes in pressure setting. The indicator light does not light up.

<Operating procedure>

- Keep the [S] button pressed for 2 seconds or longer in the measurement mode. "S_U" and current set value are displayed alternately.



- Press the [A] or [V] button to select whether or not the switch output is used.

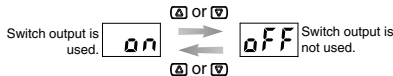

- After selected, keep the [S] button pressed for 2 seconds or longer. The setting is then completed to return to the measurement mode.

2. Display color (CoL)

Four kinds of display can be selected.

switch		Display
ON	OFF	
Red	Green	Sor
Green	Red	SoG
Red		rEd
Green		Grn

<Operating procedure>

- Keep the [S] button pressed for 2 seconds or longer in the measurement mode. When "S_U" is displayed, press the [S] button. "CoL" and current set value are displayed alternately.

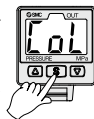
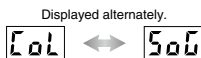

- Press the [A] or [V] button to select a display color you want to use.

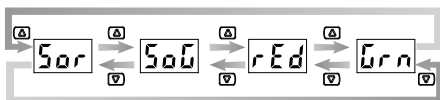

- After selected, keep the [S] button pressed for 2 seconds or longer. The setting is then completed to return to the measurement mode.

3. Response time (rES)

The switch output response time can be set to a desired level. As the response time is changed, the display update time is also changed accordingly. If the switch output or display chatters, make the response time longer.

<Operating procedure>

- Keep the [S] button pressed for 2 seconds or longer in the measurement mode. When "rES" is displayed, press the [S] button twice. "rES" and current set value are displayed alternately.



- Press the [A] or [V] button to select a response time you want to use.

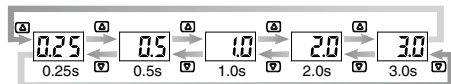

- After selected, keep the [S] button pressed for 2 seconds or longer. The setting is then completed to return to the measurement mode.

4. Operation mode (oPE)

The switch operation mode can be selected.

For details about operation in the hysteresis mode or window comparator mode, refer to "List of output modes" on page 362.

<Operating procedure>

- Keep the [S] button pressed for 2 seconds or longer in the measurement mode. When "S_U" is displayed, press the [S] button three times. "oPE" and current set value are displayed alternately.



- Press the [A] or [V] button to select an operation mode you want to use.

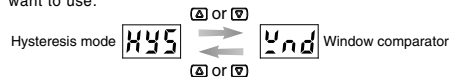

- After selected, keep the [S] button pressed for 2 seconds or longer. The setting is then completed to return to the measurement mode.

Function Settings

Pressure Setting (Window comparator mode)

<Operating procedure>

- 1 Press the **[S]** button in the measurement mode to display the set value.

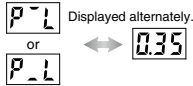

- 2 Press the **[Δ]** or **[▽]** button to change the set value.
Pressing the **[Δ]** button will increase the set value while pressing the **[▽]** button will decrease the set value.
 - Press the **[Δ]** button once to increase the numeric value. Keep the **[Δ]** button pressed to continuously increase the numeric value.



- Press the **[▽]** button once to decrease the numeric value. Keep the **[▽]** button pressed to continuously decrease the numeric value.



- 3 Press the **[S]** button to display the set value at the 2nd location.

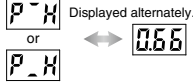

- 4 Press the **[Δ]** or **[▽]** button to change the set value.

- 5 Press the **[S]** button to complete the setting.

5. Hysteresis (H)

A hysteresis can be set.

<Operating procedure>

- 1 Keep the **[S]** button pressed for 2 seconds or longer in the measurement mode.
When "S" is displayed, press the **[S]** button four times. "H" and current set value are displayed alternately.



- 2 Press the **[Δ]** or **[▽]** button to set a hysteresis you want to use.

- Press the **[Δ]** button once to increase the numeric value. Keep the **[Δ]** button pressed to continuously increase the numeric value.



- Press the **[▽]** button once to decrease the numeric value. Keep the **[▽]** button pressed to continuously decrease the numeric value.



- 3 After selected, keep the **[S]** button pressed for 2 seconds or longer. The setting is then completed to return to the measurement mode.

6. Output mode (oU \bar{L})

A desired switch output mode can be set.

For details about operation in the normally open or normally close mode, refer to "List of output modes" on page 362.

<Operating procedure>

- 1 Keep the **[S]** button pressed for 2 seconds or longer in the measurement mode.
When "S" is displayed, press the **[S]** button five times. "oU \bar{L} " and current set value are displayed alternately.



- 2 Press the **[Δ]** or **[▽]** button to select an output mode you want to use.

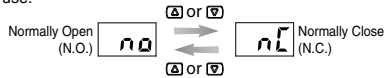

- 3 After selected, keep the **[S]** button pressed for 2 seconds or longer. The setting is then completed to return to the measurement mode.

7. Power-saving mode (Po \bar{U})

When the power-saving mode is selected, the numeric value display disappears to reduce the current consumption.

<Operating procedure>

- 1 Keep the **[S]** button pressed for 2 seconds or longer in the measurement mode.
When "S" is displayed, press the **[S]** button six times. "Po \bar{U} " and current set value are displayed alternately.

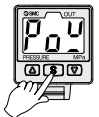

- 2 Press the **[Δ]** or **[▽]** button to select whether or not the power-saving mode is used.

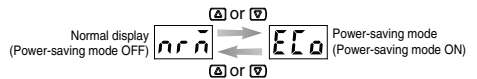

- 3 After selected, keep the **[S]** button pressed for 2 seconds or longer. The setting is then completed to return to the measurement mode.

When any key is operated in the power-saving mode, the display changes to the normal display. When no key is operated for 30 seconds, the display returns to the power-saving mode. (Measurement mode only)

In the power-saving mode, the display becomes that shown in the Fig. on the right.



HAA
HAW

AT

IDF
IDU

IDF
IFS

IDFA

IDFB

IDH

ID

IDG

IDK

AMG

AFF

AM

AMD

AMH

AME

AMF

ZFC

SF

SFD

LLB

AD

GD

Function Settings

8. Security code setting (Pin)

It can be set whether code number input is required or not in the key lock mode.

<Operating procedure>

- Keep the **[S]** button pressed for 2 seconds or longer in the measurement mode.
When "S_U" is displayed, press the **[S]** button seven times. "Pin" and current set value are displayed alternately.

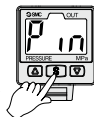

- Press the **[Δ]** or **[▽]** button to select whether or not the security code entry is used.



- After selected, keep the **[S]** button pressed for 2 seconds or longer. The setting is then completed to return to the measurement mode.

When you select to use the security code entry, you need to enter the security code so as to unlock the key. A desired security code can be set by the user.

With the factory default settings, the security code is set at "000".

When you select to use the security code entry, please also refer to page 363.

• List of output modes

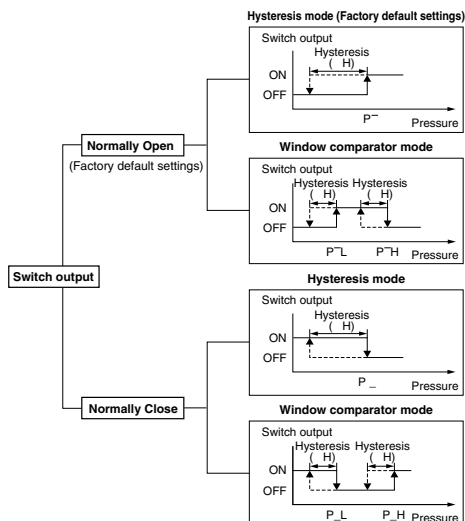

If the switch output change point becomes beyond the set pressure range as the pressure set value is changed, the hysteresis (H) is corrected automatically.

• Display mode (dIS)

The display can be flipped vertically.

The following describes how to change the display mode after the product has been purchased.

<Operating procedure>

- Keep the **[S]** button pressed for 2 seconds or longer in the measurement mode.
When "S_U" is displayed, press the **[S]** button eight times. "dIS" and current set value are displayed alternately.



- Press the **[Δ]** or **[▽]** button to select a display mode you want to use.

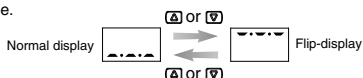

- After selected, keep the **[S]** button pressed for 2 seconds or longer. The setting is then completed to return to the measurement mode.

When the flip-display is selected, the button operation is changed as shown in the Fig. on the right.

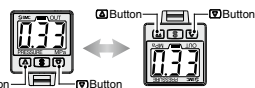

Other Settings

• Peak/Bottom value display function

The maximum (minimum) pressure up to now from the power ON is detected to update the data. This pressure is displayed in the peak (bottom) value display mode. In the peak value display mode, keep the **[Δ]** button pressed for 1 second or longer to blink the maximum pressure value and hold it. To cancel the hold display, keep the **[Δ]** button pressed for 1 second or longer again. In the bottom value display mode, keep the **[▽]** button pressed for 1 second or longer to blink the minimum pressure value and hold it. To cancel the hold display, keep the **[▽]** button pressed for 1 second or longer again. Keep the **[Δ]** and **[▽]** buttons pressed at the same time for 1 second or longer during hold display to initialize the maximum (minimum) pressure value.

• Zero-clear function

The display value can be adjusted to zero when the pressure to be measured is within the range of $\pm 10\%$ F.S. from the factory default setting.

(Due to individual product differences, the zero-clear range varies ± 1 digit.)

Keep the **[Δ]** and **[▽]** buttons pressed at the same time for 1 second or longer to reset the display value to zero.

The mode then returns to the measurement mode automatically.

• Keylock function

This function prevents incorrect operations such as accidentally changing the set-value. If any button is operated when the key is locked, "LoC" is displayed for approx. 1 sec.

<Operating procedure - Security code is not used.>

- 1 Keep the **[S]** button pressed for 5 seconds or longer in the measurement mode.

The current setting "LoC" or "UnL" is displayed. (Perform the same operation when unlocking the key.)



- 2 Press the **[Δ]** or **[▽]** button to select "Lock" or "Unlock".



- 3 Press the **[S]** button to set the selection.

<Operating procedure - Security code is used.>

• Lock setting

- 1 Keep the **[S]** button pressed for 5 seconds or longer in the measurement mode.

"UnL" is then displayed.



- 2 Press the **[Δ]** or **[▽]** button to select the lock "LoC".

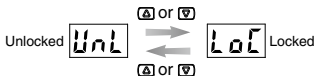

- 3 Press the **[S]** button to set the selection.

• Unlock setting

- 1 Keep the **[S]** button pressed for 5 seconds or longer in the measurement mode.

"LoC" is then displayed.

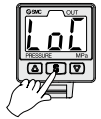

- 2 Press the **[Δ]** or **[▽]** button to select the unlock "UnL".

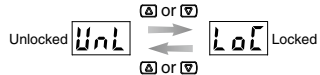

- 3 Press the **[S]** button. You are prompted to enter the security code.

For details about how to enter the security code, refer to "Security code entering/changing procedure" described below.



- 4 When the secret code is correct, "UnL" is displayed. Press any of the **[Δ]**, **[S]**, and **[▽]** buttons. The key is unlocked to return to the measurement mode.

If the security code is incorrect, "FAL" is displayed and you are prompted to enter the security code again. If the security code entry is continuously failed three times, "LoC" is displayed to return to the measurement mode.

Changing of security code

With the factory default settings, the security code is set at "000", but it can be changed to a desired value.

<Operating procedure>

- 1 Make the lock setting (described on the left). After setting, make the unlock setting (steps 1 to 3 shown above).

- 2 When "UnL" is displayed, keep the **[S]** and **[▽]** buttons pressed at the same time for 5 seconds or longer. "000" is displayed, and then you are prompted to change the security code.

For details about how to enter the security code, refer to "Security code entering/changing procedure" described below.

After a desired security code has been entered completely, the set security code is displayed.

- 3 After checking, press the **[S]** button.

The mode returns to the measurement mode.

At this time, when pressing the **[Δ]** or **[▽]** button, the security code is not changed and you are prompted to change the security code again.

• Security code entering/changing procedure

The 1st digit starts blinking.

Press the **[Δ]** or **[▽]** button to set the numeric value.

Press the **[S]** button. The numeric value at the next digit starts blinking. (When pressing the **[S]** button at the most significant digit, the 1st digit then starts blinking.)

After a desired security code has been entered completely, keep the **[S]** button pressed for 1 second or longer.

(If no key is operated for 30 seconds or longer during security code entry/change operation, the mode will return to the measurement mode automatically.)

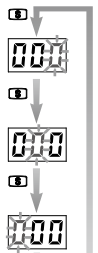

HAA
HAW

AT

IDF
IDU

IDF
IFS

IDFA

IDFB

IDH

ID

IDG

IDK

AMG

AFF

AM

AMD

AMH

AME

AMF

ZFC

SF

SFD

LLB

AD

GD

LLB1 Series

Pressure Switch



Model

PSE510 - R06

• Piping specifications

R06 | ø6 reducer

• Pressure specifications

0 | For high-pressure (0 to 1 MPa)

Specifications

Model	PSE510-06	
Operating pressure range	0 to 1 MPa	
Maximum operating pressure	1 MPa	
Fluid	Air/Non-corrosive gas	
Output specifications	Analog output (1 to 5 V Load impedance: 10 kΩ or more)	
Power supply voltage	12 to 24 VDC (Ripple ±10% or less)	
Current consumption	10 mA or less	
Operating temperature range	0 to 50°C (No condensation)	
Temperature characteristics (Based on 25°C)	25±10°C	±1%F.S. or less
	0 to 50°C	±1.5%F.S. or less
Repeatability	±0.3%F.S. or less	
Withstand voltage	1000 VAC 50/60 Hz for 1 min. between external terminal and case	
Insulation resistance	2 MΩ (500 VDC measured via megohmmeter) between external terminal and case	
Vibration resistance	10 to 500 Hz Pulse width 1.5 mm or acceleration 98 m/s ² (at the smaller vibration) to X, Y, Z direction (2 hours)	
Impact resistance	980 m/s ² to X, Y, Z direction (3 times for each direction)	
Enclosure	IP40	

Internal Circuit

Lead wire colors inside () in the internal circuit of the contact protection box are those prior to conformity with IEC standards.

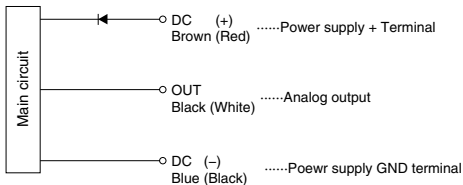

Dimensions

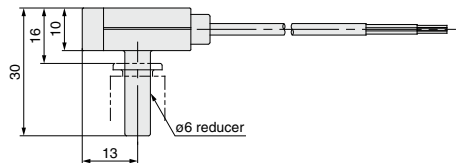

Element Replacing Procedure

1. Remove the case.

- Remove the hexagon socket head cap screws (4 locations) that secure the case and pull out the case in the direction indicated by an arrow.
- To remove the hexagon socket head cap screws, use the hexagon wrench for M3 (width across flats, 2.5).

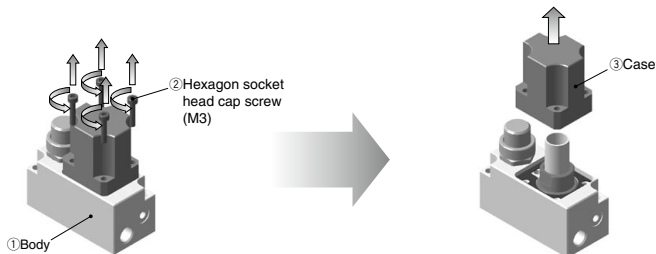

2. Remove the element.

- Take out the stopper and pull out the element in the direction indicated by an arrow.

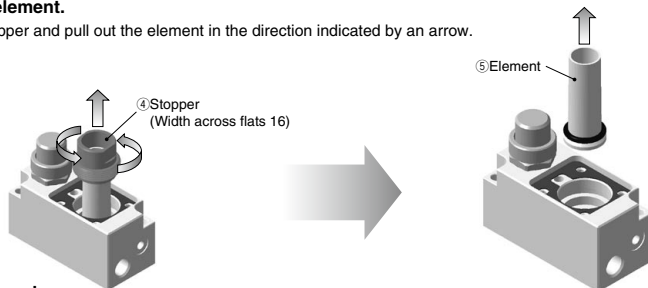

3. Mount an element.

- Mount a new element.
- Lightly screw in the stopper by hand and tighten it with a tool such as spanner until it is no longer turned.

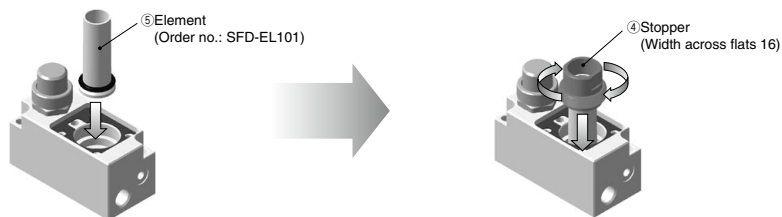

4. Mount the case.

- Mount the case in the direction indicated by an arrow and secure it with the hexagon socket head cap screws (4 locations).
- To tighten the hexagon socket head cap screws, use the hexagon wrench for M3 (width across flats, 2.5).
- *Tightening torque 0.6 to 1 N·m

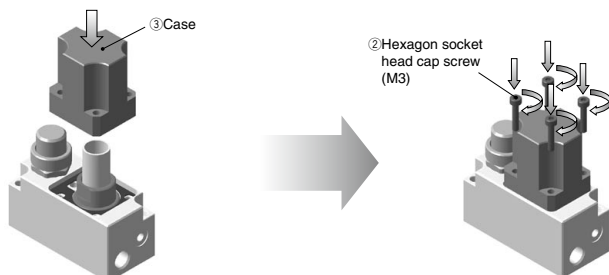

HAA
HAW
AT
IDF
IDU
IDF
<input type="checkbox"/> FS
IDFA
IDFB
IDH
ID
IDG
IDK
AMG
AFF
AM
AMD
AMH
AME
AMF
ZFC
SF
SFD
LLB
AD <input type="checkbox"/>
GD



LLB1 Series Air-blow Module/Precautions 1

Be sure to read this before handling the products.
Refer to back page 50 for Safety Instructions.

Design and Selection

Warning

1. Confirm the specifications.

Give careful consideration to the operating conditions such as the application, fluid and environment, and use within the operating ranges specified in this catalog.

2. Ensure sufficient space for maintenance activities.

Provide space required for maintenance.

3. Fluid pressure range

Supplied fluid pressure must be within the operating pressure range specified in the catalog.

Mounting

Warning

1. If air leakage increases or equipment does not operate properly, stop operation.

After mounting is completed, confirm that it has been done correctly by performing a suitable function test and leakage test.

Operating Environment

Warning

1. Do not operate under the conditions listed below due to a risk of malfunction.

In locations having corrosive gases, organic solvents, and chemicals, or in locations in which these elements are likely to adhere to the equipment.

In locations in which salt water, water, or water vapor could come in contact with the equipment.

In locations that are exposed to direct sunlight. (Shield the equipment from sunlight to prevent its resin material from ultraviolet ray degradation or overheating.)

In locations that have a heat source and poor ventilation.

(Shield the equipment from heat sources to protect it from softening degradation due to radiated heat.)

In locations that are exposed to shocks and vibrations.

In locations with high humidity or a large amounts of dust.

2. When the product is used for blowing, use caution to prevent the work from being damaged by entrained air from the surrounding area.

When the compressed air is used for air blow, the exhausted air from the blow nozzle may have taken in airborne foreign matter (such as solid particle, fluid particle) from the surrounding air. The foreign matter will be sprayed on the work, and the airborne foreign matter may adhere to it. Therefore, use caution for the surrounding environment.

Recommended Pneumatic Circuit

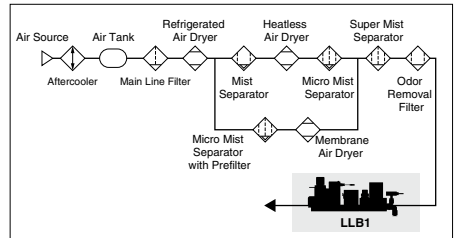

3. ISO compressed air quality class

The class regarding the cleanliness of compressed air (solid particles, moisture and oil) stipulated by ISO 8573-1: 1991 (JIS B8392-1: 2000)

Quality class	Maximum particle size (μm)	Minimum pressure dew point (°C)	Maximum oil concentration (mg/m ³)
1	0.1	-70	0.01
2	1	-40	0.1
3	5	-20	1.0
4	15	3	5
5	40	7	25
6	—	10	—

Notation system

Example) Solid particle size: 0.1 μm

Pressure dew point: 3°C

Oil concentration: 0.1mg/m³

With the above conditions, notation of the quality class is 1, 4, 2.



LLB1 Series

Air-blow Module/Precautions 2

Be sure to read this before handling the products.
Refer to back page 50 for Safety Instructions.

Piping

Caution

1. Preparation before piping

Before piping is connected, it should be thoroughly blown out with air (flushing) or washed to remove chips, cutting oil and other debris from inside the pipe.

Install piping so that it does not apply pulling, pressing, bending or other forces on the module unit.

2. Cautions on use of One-touch fittings

1) Installation of tubing

(1) Cut the tubing perpendicularly, being careful not to damage the outside surface. Use an SMC tube cutter "TK-1", "TK-2" or "TK-3". Do not cut the tubing with pliers, nippers, scissors, etc. If the tubing is cut with a tool other than the tube cutter, the tubing cut surface becomes slant or flattened.

The tubing cannot be connected securely, causing the tubing disconnection or air leak after connection. Additionally, cut the tubing with sufficient length.

(2) Grasp the tubing, slowly push it into the One-touch fitting until it comes to a stop.

(3) Pull the tubing back gently to make sure it has a positive seal. Insufficient installation may cause air to leak or the tubing to release.

(4) Do not apply unnecessary forces such as twisting, pulling, moment loads, vibration and impact, etc. on fittings or tubing.

2) Removal of tubing

(1) Push the release button flange evenly and sufficiently to release the tube.

(2) Pull out the tubing while keeping the release button depressed. If the release button is not held down sufficiently, the tubing cannot be withdrawn.

(3) To reuse the tubing, remove the previously lodged portion of the tubing. If the lodged portion is left on without being removed, it may result in air leakage and removal of the tubing difficult.

Other Tube Brands

Caution

1. When tubing of brands other than SMC's are used, verify that the tubing O.D. satisfies the following accuracy;

- 1) Polyolefin tubing: Within ± 0.1 mm
- 2) Polyurethane tubing: Within $+0.15$ mm, within -0.2 mm
- 3) Nylon tubing: Within ± 0.1 mm
- 4) Soft nylon tubing: Within ± 0.1 mm

Do not use tubing which does not meet these outside diameter tolerances. It may not be possible to connect them, or they may cause other trouble, such as air leakage or the tube pulling out after connection.

The recommended tube for the clean fitting is polyolefin tube. Other tubes can satisfy the performance in terms of leakage, tensile strength, etc., but impair the cleanliness. Note this point for use.

HAA
HAW
AT
IDF
IDU
IDF
<input type="checkbox"/> FS
IDFA
IDFB
IDH
ID
IDG
IDK
AMG
AFF
AM
AMD
AMH
AME
AMF
ZFC
SF
SFD
LLB
AD <input type="checkbox"/>
GD



LLB1 Series

Specific Product Precautions 1

Be sure to read this before handling the products.
Refer to back page 50 for Safety Instructions.

Precautions on Regulator

Design and Selection

⚠ Warning

1. Confirm the specifications.

Products represented in this catalog are designed only for use in compressed air systems. Do not operate at pressures or temperatures, etc., beyond the range of specifications, as this can cause damage or malfunction. Please contact SMC when using a fluid other than compressed air.

2. Do not use the products described in this catalog as “safety accessories” defined in 2.1.3 of Article 1 and in 1.4 of Article 3 in “Pressure Equipment Directive (97/23/EC)”.

In “Pressure Equipment Directive”, “safety accessories” are defined as devices that are designed to prevent the pressure equipment from exceeding its allowable limit value.

3. Check the set pressure range.

Be sure to install an appropriate safety device if it is predicted that the output pressure exceeding the set pressure range may cause the outlet equipment to break or malfunction.

4. Residual pressure relief when releasing the inlet pressure

When releasing the inlet pressure with the outlet pressure set at low pressure level, the outlet pressure may not be removed (residual pressure relief).

Be sure to install an appropriate pressure relief circuit to remove the outlet pressure completely.

5. Product is used in the closed circuit or balance circuit at the outlet.

Please contact SMC since the product may not be used in such circuit.

Adjustment

⚠ Warning

1. Set the regulator while verifying the displayed values of the inlet and outlet pressure gauges.

Turning the knob excessively can cause damage to the internal parts.

2. Do not use a tool on the pressure regulator knob as this can cause damage. It must be operated by hand.

⚠ Caution

1. Check the inlet pressure before setting.

2. Set the outlet pressure range for the regulator in a range that is 85% or less of the inlet pressure.

At this time, be sure to set the outlet pressure within the set pressure range.

3. Adjust pressure after unlocking the pressure regulator knob. If the steps are performed in incorrect order, this may cause the knob to break or the outlet pressure to fluctuate.

4. Rotating the knob clockwise increases the outlet pressure, and rotating the knob counterclockwise decreases the pressure. (Set the pressure in the increase direction.)

5. Pressure gauge indicator adjusting procedure.

When adjusting the indicator on the pressure gauge, be sure to follow the steps below since an open/close type lens is used.

1. Open the lens by fingernail in the direction indicated by an arrow.

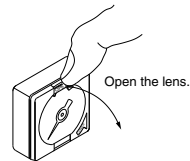

2. Adjust the indicator needle with a flat blade screwdriver.

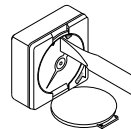

3. Close the lens in the direction indicated by an arrow and push it until the snapping sound is heard.

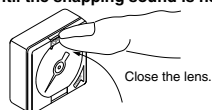



LLB1 Series

Specific Product Precautions 2

Be sure to read this before handling the products.
Refer to back page 50 for Safety Instructions.

Precautions on Regulator

Handling

Warning

Mount the regulator while carefully observing the screw tightening torque.

If the screw is tightened with a tightening torque exceeding the specified level, this may cause the mounting screw, body, or switch, etc. to break.

Additionally, if the screw is tightened with a tightening torque less than the specified level, the connection thread part may become loose.

1. Tightening torque of the holding screw securing the blanking plate to the body

- 1) Mount the O-ring into the O-ring groove of the body.
- 2) With the square nuts (1 pc. each on the diagonal left and right) mounted on the body, mount the blanking plate with two holding screws.

Tightening torque: 0.32 ± 0.03 N·m

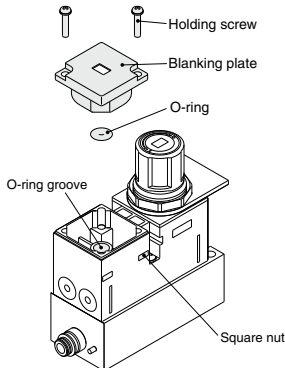

2. Tightening torque of the holding screw securing the pressure gauge to the body

- 1) Mount the O-ring into the O-ring groove of the body.
- 2) Turn the cover assembly 15° in the direction indicated by an arrow to remove it upward.
- 3) With the square nuts (1 pc. each on the diagonal left and right) mounted on the body, mount the pressure gauge with the holding screws.

Tightening torque: 0.32 ± 0.03 N·m

- 4) Insert the convex parts on the bottom of the cover assembly into the concave parts of the pressure gauge, and then turn the cover assembly 15° in the direction opposite to the direction indicated by an arrow.

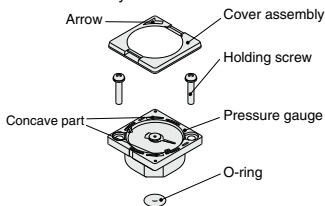

3. The digital pressure switch to the body Tightening torque of the holding screw securing

- 1) Mount the O-ring into the O-ring groove of the body.
- 2) With the square nuts (1 pc. each on the diagonal left and right) mounted on the body, put the groove part of the adapter on the side opposite to the knob, and then mount the adapter with two holding screws.
- Tightening torque: 0.32 ± 0.03 N·m
- 3) Mount the switch body.
- 4) Insert the lock pin all the way inside the groove part of the adapter.

The switch body can be replaced by removing and inserting the lock pin.

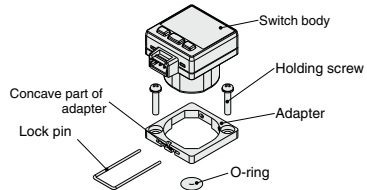

4. The regulator to the manifold block Tightening torque of the holding screw securing

- 1) Mount two O-rings into the O-ring groove of the regulator body.
- 2) Mount the regulator body on the manifold block with two holding screws.

Tightening torque: 0.32 ± 0.03 N·m

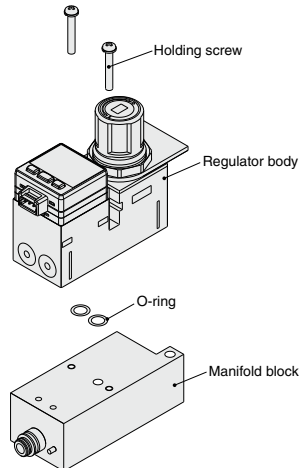

HAA
HAW
AT
IDF
IDU
IDF
IFS
IDFA
IDFB
IDH
ID
IDG
IDK
AMG
AFF
AM
AMD
AMH
AME
AMF
ZFC
SF
SFD
LLB
AD
GD



LLB1 Series

Specific Product Precautions 3

Be sure to read this before handling the products.
Refer to back page 50 for Safety Instructions.

Precautions on Regulator

Handling

⚠ Caution

One-touch fitting replacing procedure

One-touch fitting is a type of cassette. So, it can be replaced easily.

One-touch fitting is secured with the clip from the bottom of the regulator body to prevent disconnection. After the regulator has been removed, take out the clip with a flat blade screwdriver and replace the One-touch fitting with a new one.

To mount a new One-touch fitting, insert it until it is in contact with the inner part, and then insert the clip to the specified position again.

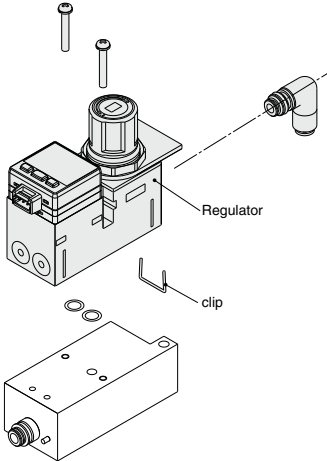

Connector mounting procedure

Pinch the lever and connector body by fingers and insert the lever straight into the pin. Push the lever claw into the concave groove of the switch body to lock it.

Connector removing procedure

Push down the lever by your thumb to disengage the claw from the concave groove and pull out the lever straight to remove it.

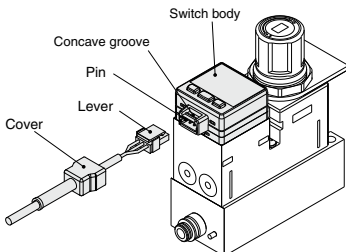



LLB1 Series

Specific Product Precautions 4

Be sure to read this before handling the products.
Refer to back page 50 for Safety Instructions.

Precautions on Digital Pressure Switch

Warning

1. Do not attempt to disassemble, modify (including exchanging the printed circuit boards), or repair the product.

An injury or failure can result.

2. Do not operate the product beyond the specifications.

Otherwise, a fire, malfunction or switch damage can result.

3. Do not use in an environment where flammable gas or explosive gas exists.

Usage may cause a fire or explosion. This digital pressure switch does not have the explosion protected construction.

4. Do not use the product in a place where static electricity is a problem.

It may result in system failure or malfunction.

Caution

Be sure to perform appropriate functional inspection and leak inspection after completion of the maintenance and inspection work.

Stop the operation if any trouble, such as malfunction or leak is found.

If any leak occurs in a part other than the piping, the pressure sensor may be broken. If this happens, shut down the power and stop the pressure supply.

Otherwise, an unexpected malfunction may occur and it will become impossible to secure the safety.

Handling precautions

Strictly observe the contents shown below when handling the digital pressure switch.

Otherwise, the digital pressure switch may be broken or become faulty, causing a malfunction.

- Do not drop or hit the switch or apply an excessive impact (100m/s²) to it.
- Do not stretch the lead wire strongly or raise the switch by pulling the lead wire. (Tensile strength, 50N or less)
- Do not make any incorrect wiring.
- Do not perform the wiring work with the power turned ON.
- Do not run the wiring in the same route as the power cable or high-voltage line.
- Ground the FG terminal securely when using a generally available switching power supply.
- Do not push a setting button with a sharp object.
- Perform the warm-up operation for 20 to 30 min.

A display drift of approx. ±1% occurs immediately after the power has been turned ON.

- Use a UL certified product that is a class 2 power supply unit in conformity with UL1310 or a class 2 transformer in conformity with UL1585 for DC power supply to be combined.
- The digital pressure switch becomes a UL certified product only when the UL mark is put on the switch body.

Descriptions and functions

Body

Indicator light (green): Displays the switch operation status.

3-digit LED: Displays the current pressure condition, set mode and error code. The display mode can be selected from four options: fixed green single-color reading, fixed red single-color reading, green reading interlocked with output for switching to red reading, or red reading interlocked with output for switching to green reading.

button: Use this button to change the mode or increase the ON/OFF set value. It also allows you to switch to the peak value display mode.

button: Use this button to change the mode or decrease the ON/OFF set value. It also allows you to switch to the bottom value display mode.

button: Use this button to switch the mode and set the set value.

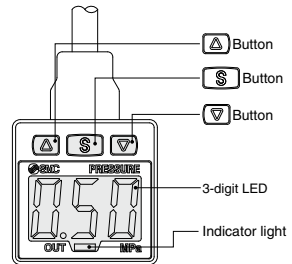

HAA
HAW
AT
IDF
IDU
IDF
IFS
IDFA
IDFB
IDH
ID
IDG
IDK
AMG
AFF
AM
AMD
AMH
AME
AMF
ZFC
SF
SFD
LLB
AD
GD



LLB1 Series

Specific Product Precautions 5

Be sure to read this before handling the products.
Refer to back page 50 for Safety Instructions.

Precautions on ON/OFF Valve

Design

⚠ Warning

1. Cannot be used as an emergency shutoff valve, etc.

The valves presented in this catalog are not designed for safety applications such as an emergency shutoff valve. If the valves are used in this type of system, other reliable safety assurance measures should also be adopted.

2. This solenoid valve cannot be used for explosion proof applications.

3. Ensure sufficient space for maintenance activities.

Provide space required for maintenance.

4. Pressure (including vacuum) holding

It is not usable for an application such as holding the pressure (including vacuum) inside of a pressure vessel because air leakage is entailed in a valve.

Selection

⚠ Warning

1. Confirm the specifications.

Give careful consideration to the operating conditions such as the application, fluid and environment, and use within the operating ranges specified in this catalog.

2. Fluid

1) Type of fluids

Confirm the material of the parts in contact with fluid and applicable fluid to verify whether or not the fluid can be used.

2) Flammable fluid

Cannot be used in the flammable fluid.

3) Corrosive gas

Cannot be used since it will lead to cracks by stress corrosion or result in other incidents.

3. Air quality

1) Use clean air.

Do not use compressed air that contains chemicals, synthetic oils including organic solvents, salt or corrosive gases, etc., as it can cause damage or malfunction.

2) Install air filters.

Install air filters close to valves at their upstream side. A filtration degree of 5 μm or less should be selected.

3) Install an aftercooler or air dryer, etc.

Compressed air that contains excessive drainage may cause malfunction of valves and other pneumatic equipment. To prevent this, install an aftercooler or air dryer, etc.

4) If excessive carbon powder is generated, eliminate it by installing mist separators at the upstream side of valves.

If excessive carbon powder is generated by the compressor, it may adhere to the inside of the valves and cause malfunction.

Refer to SMC Best Pneumatics catalog for further details on compressed air quality.

Selection

⚠ Warning

4. Ambient environment

Use within the operable ambient temperature range.

Confirm the compatibility between the product's composition materials and the ambient atmosphere. Be certain that the fluid used does not touch the external surface of the product.

5. Countermeasures against static electricity

Take measures to prevent static electricity since some fluids can cause static electricity.

⚠ Caution

1. Leakage voltage

In particular, when a resistor is used in parallel with the switching element or when a C-R element (surge voltage suppressor) is used to protect the switching element, the leakage current flows through the resistor or C-R element, causing the valve not to turn OFF. Carefully check this point.

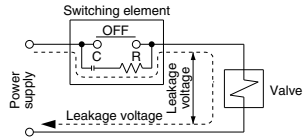

DC coil is 2% or less of the rated voltage.

2. Low temperature operation

1. The valve can be used in an ambient temperature of between -10 to -20°C . However, take measures to prevent freezing or solidification of impurities, etc.



LLB1 Series

Specific Product Precautions 6

Be sure to read this before handling the products.
Refer to back page 50 for Safety Instructions.

Precautions on ON/OFF Valve

Mounting

⚠ Warning

1. If air leakage increases or equipment does not operate properly, stop operation.

After mounting is completed, confirm that it has been done correctly by performing a suitable function test.

2. Do not apply external force to the coil section.

When tightening is performed, apply a wrench or other tool to the outside of the piping connection parts.

3. Avoid sources of vibration, or adjust the arm from the body to the minimum length so that resonance will not occur.

Piping

⚠ Caution

1. Preparation before piping

Before piping is connected, it should be thoroughly blown out with air (flushing) or washed to remove chips, cutting oil and other debris from inside the pipe.

Install piping so that it does not apply pulling, pressing, bending or other forces on the module unit.

Operating Environment

⚠ Warning

1. Do not use the product in a place where corrosive gas, chemicals, brine, water and/or water steam are present or can splash on it.
2. Do not use the product in a place with the explosive atmosphere.
3. Avoid using the product in a place where vibration or impact can occur.
4. Do not use the product in the vicinity of a heat source or under radiant heat.
5. In locations where there is contact with spatter from water, oil, solder, etc., take suitable protective measures.

Lubrication

⚠ Caution

1. This solenoid valve can be used without lubrication.

Maintenance

⚠ Warning

1. Low frequency operation

Switch valves at least once every 30 days to prevent malfunction. Also, in order to use it under the optimum state, conduct a regular inspection once a half year.

2. Do not disassemble the product. Once the product has been disassembled, SMC does not warrant such product.

When it is required to disassemble the product, contact SMC or SMC sales representative.

Connection and electric circuit diagram

⚠ Caution

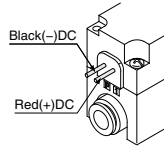

With power-saving circuit (Polarity is provided.)

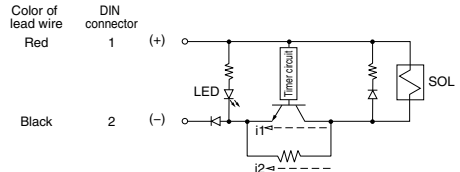

i1: Starting current i2: Holding current

In the DC (with power-saving circuit) specifications, the circuit shown above is used to reduce the power consumption during holding and achieve the energy saving. Please refer to the electric wave data below.

Electric waveform of power-saving type (at rated voltage of 24 VDC)

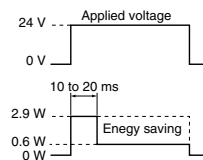

HAA
HAW

AT

IDF
IDU

IDF
IFS

IDFA

IDFB

IDH

ID

IDG

IDK

AMG

AFF

AM

AMD

AMH

AME

AMF

ZFC

SF

SFD

LLB

AD

GD



LLB1 Series

Specific Product Precautions 7

Be sure to read this before handling the products.
Refer to back page 50 for Safety Instructions.

Precautions on Restrictor

Precautions

Warning

- 1. Restrictor cannot be used as a stop valve, which requires zero leakage. It is tolerant to some extent of leakage as a specification.**
- 2. Check the number of rotations of the needle valve.**
It does not rotate further because it has a drop-out prevention

mechanism. Check the number of needle rotations. Rotating the needle too much may cause damage.

- 3. Do not use tools such as pliers to rotate the knob.**
It can cause idle rotation of the knob or damage.

Precautions on Filter

Installation

Warning

- 1. Air equipment which is mounted on the outlet side may generate dust.**
If air equipment is installed on the outlet side, the equipment may generate dust, and it will be a factor to deteriorate cleanliness. Examine the position to install air equipment.
- 2. Set operating flow rate within the specified range.**
[Specified range]
LLB1: 100 L/min (ANR) or less
If the operating flow rate is out of the specified range, it will cause functional deterioration and breakage.
- 3. The filter should be installed in a place where pulsation does not occur.**
- 4. This product cannot operate compressed air which contains fluid such as water and oil.**

- For the air source for this product, install a dryer, mist separator, micro mist separator, super mist separator, odor removal filter, etc.
- Generally, compressed air contains following particle contaminants:
[Example of particle contaminants contained in compressed air]
 - Moisture (Condensate)
 - Dust in atmospheric air
 - Deteriorated oil exhausted from the compressor
 - Solid foreign matter such as rust or oil in the piping

- 5. Flush air into the piping for cleaning before installing the product.**

To decrease the affect of dust from a connection, also flush air into the piping before using the product for the first time and when replaced.

Maintenance

Warning

- 1. When removing the product, exhaust the air and ensure the air is released to atmosphere before removing it.**
- 2. When the element comes to the end of its life, immediately replace it with a new filter or replacement element.**

—Service life of element—

- 1) After 1 year of usage has elapsed.
- 2) When the set flow rate is not achieved even if it has been less than 1 year since operation started.

Operating Environment

Warning

- 1. Do not operate under the conditions listed below due to a risk of malfunction.**
 - In locations having corrosive gases, organic solvents, and chemicals, or in locations in which these elements are likely to adhere to the equipment.
 - In locations in which salt water, water, or water vapor could come in contact with the equipment.
 - In locations that are exposed to direct sunlight. (Shield the equipment from sunlight to prevent its resin material from ultraviolet ray degradation or overheating.)
 - In locations that have a heat source and poor ventilation. (Shield the equipment from heat sources to protect it from softening degradation due to radiated heat.)
 - In locations that are exposed to shocks and vibrations.
 - In locations with high humidity or a large amounts of dust.

- 2. When the product is used for blowing, use caution to prevent the work from being damaged by entrained air from the surrounding area.**

When the compressed air is used for air blow, the exhausted air from the blow nozzle may have taken in airborne foreign matter (such as solid particle, fluid particle) from the surrounding air. The foreign matter will be sprayed on the work, and the airborne foreign matter may adhere to it. Therefore, use caution for the surrounding environment.