

Air Slide Table

MXP Series

ø6, ø8, ø10, ø12, ø16

RoHS

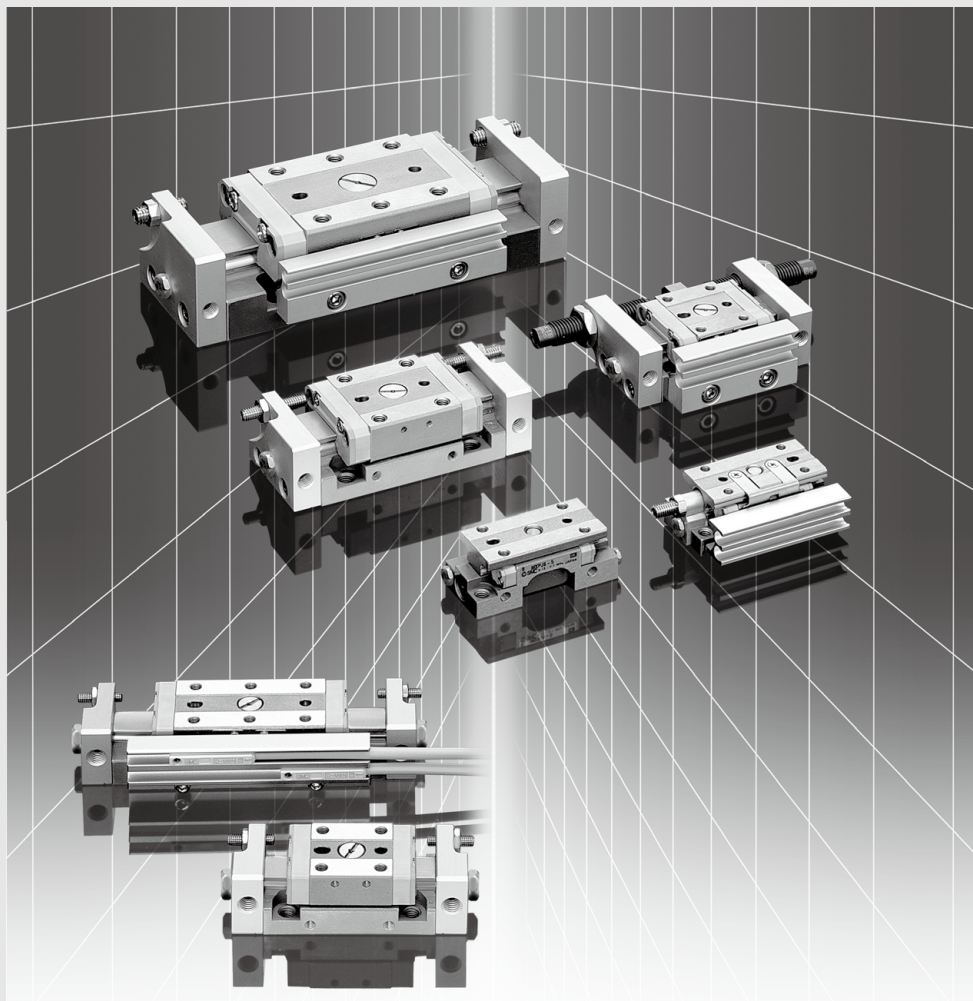

MXH

MXS

MXQ

MXQ

MXF

MXW

MXJ

MXP

MXY

MTS

D-

-X

Cylinder: Built-in Linear Guide

High rigidity, High precision

Cylinder is built into the rail of the linear guide.
Material of body and guide block is martensitic stainless steel.

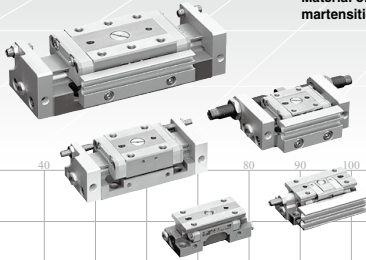
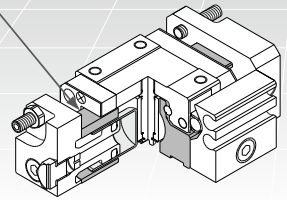

Stroke adjuster

Three types (rubber stopper, metal stopper, shock absorber) are available.

With shock absorber

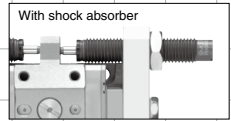

MXP
8,10,
12,16

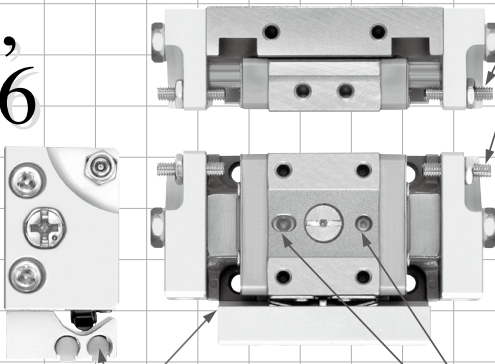

Auto switch attachable

Switch rail and magnet (Standard)
Without switch rail and magnet are optional.

Without switch rail and magnet

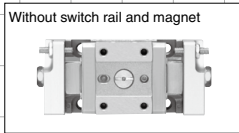

Highly flexible piping methods

Piping possible in two directions:
vertical or lateral.

Positioning pinhole

Job performance is improved
during maintenance.

Work mounting tap

- 1 Tapped on table top
- 2 Tapped on table side

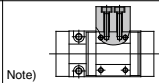
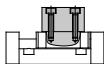

Note)
Side mounting with shock absorber and MXP6 is not available.

Highly flexible mounting direction

Mounting from 3 directions.

- 1 Body tapped
- 2 Body through-hole
- 3 Tapped on body side

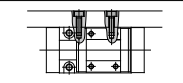
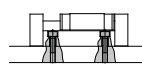
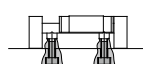

Note) Side mounting of MXP6 is not available.

Compact Air Slide Table

Travelling parallelism*: **0.004 mm**

Parallelism: **0.02 mm**

* Refer to page 335 for details of the traveling parallelism.

Numerous auto switch variations available

Reed switch, solid state switch, and 2-color indicator solid state auto switch can be mounted.

With auto switches and stroke adjuster

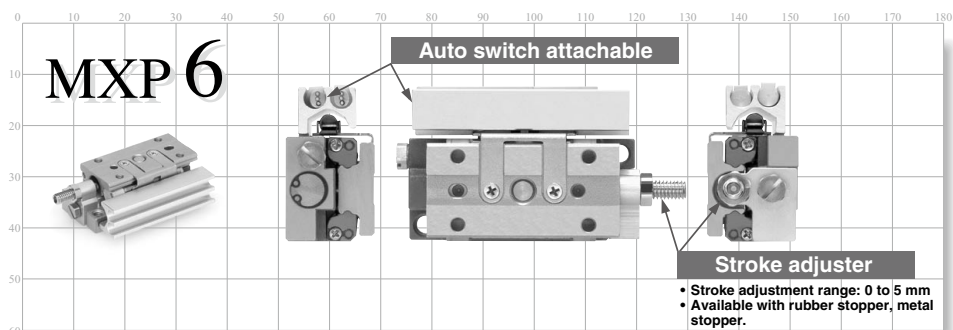

Series

MXP6

MXP8

MXP10

MXP12

MXP16

Stroke (mm)

5 10 15 20 25 30

Stroke adjuster

Rubber stopper Metal stopper Shock absorber

Auto switch

With shock absorber

Twice the allowable kinetic energy of a rubber stopper

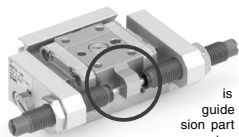

Stopping accuracy is stable, because the guide block and the collision part of a shock absorber are one-piece construction.

MXPJ6

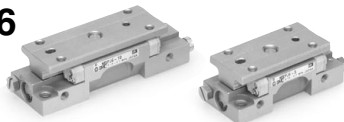

Compact: Height 17 x Width 20

Compact shape is realized by the cylinder built into the linear guide block. Material of body and table is martensitic stainless steel.

Highly flexible piping methods

Piping possible in two directions: vertical or lateral.

MXH

MXS

MXQ

MXQ

MXF

MXW

MXJ

MXP

MXY

MTS

D-

-X

MXP Series Model Selection

Model Selection Steps	Formula/Data	Selection Example
<p>1 Operating Conditions</p> <p>Enumerate the operating conditions considering the mounting position and workpiece configuration. Check that the load mass does not exceed the maximum allowable load mass and that the average operating speed does not exceed the operating speed range.</p>	<ul style="list-style-type: none"> Model to be used Mounting orientation Average operating speed V_a (mm/s) Load mass W (kg): Fig. (1); Table (2) Overhang L_n (mm): Fig. (2) 	 <p>Cylinder: MXP10-10 Mounting: Horizontal wall mounting Average operating speed: $V_a = 300$ [mm/s] Load mass: $W = 0.2$ [kg] $L_2 = 20$ mm $L_3 = 30$ mm</p>
<p>2 Kinetic Energy</p> <p>Find the kinetic energy E (J) of the load.</p> <p>Confirm that the kinetic energy of the load does not exceed the allowable kinetic energy.</p>	$E = \frac{1}{2} \cdot W \cdot \left(\frac{V}{1000}\right)^2$ <p>Collision speed $V = 1.4 \cdot V_a$ + Correction factor</p> <p>Kinetic energy (E) < Allowable kinetic energy (E_{max}) Allowable kinetic energy E_{max}: Table (1)</p>	$E = \frac{1}{2} \cdot 0.2 \cdot \left(\frac{420}{1000}\right)^2 = 0.018$ $V = 1.4 \times 300 = 420$ <p>Possible to use by $E = 0.018 < E_{max} = 0.045$</p>
<p>3 Load Factor</p>		
<p>3-1 Load Factor of Load mass</p> <p>Find the allowable load mass W_a (kg). Note) No need to consider this load factor in the case of using perpendicularly in a vertical position. (Define $\alpha_1 = 0.$)</p> <p>Find the load factor of the load mass α_1.</p>	<p>$W_a = \beta \cdot W_{max}$ Allowable load weight coefficient β: Graph (1) Max. allowable load mass W_{max}: Table (2)</p> <p>$\alpha_1 = W/W_a$</p>	<p>$W_a = 1 \times 1.2 = 1.2$ $\beta = 1$ $W_{max} = 1.2$ $\alpha_1 = 0.2/1.2 = 0.17$</p>
<p>3-2 Load Factor of Static Moment</p> <p>Find the static moment M (N-m).</p> <p>Find the allowable static moment M_a (N-m).</p> <p>Find the load factor α_2 of the static moment.</p>	<p>$M = W \times 9.8 (L_n + A_n)/1000$ Moment center position distance compensation amount A_n: Table (3)</p> <p>$M_a = \gamma \cdot M_{max}$ Allowable moment coefficient γ: Graph (2) Maximum allowable moment M_{max}: Table (4)</p> <p>$\alpha_2 = M/M_a$</p>	<p>Examine M_r. [As M_p and M_y does not arise, examination is not needed.]</p> <p>$M_r = 0.2 \times 9.8 (20 + 6.8)/1000 = 0.053$ $A_2 = 6.8$ $M_{ar} = 1 \times 4.2 = 4.2$ $\gamma = 1$ $M_{rmax} = 4.2$ $\alpha_2 = 0.053/4.2 = 0.013$</p>
<p>3-3 Load Factor of Dynamic Moment</p> <p>Find the dynamic moment M_e (N-m).</p> <p>Find the allowable dynamic moment M_{ea} (N-m).</p> <p>Find the load factor α_3 of the dynamic moment.</p>	<p>$M_e = 1/3 \cdot W_e \times 9.8 \frac{(L_n + A_n)}{1000}$ Load equivalent to collision $W_e = \delta \cdot W \cdot V$ δ: Damper coefficient Rubber stopper = 4/100 Shock absorber = 1/100 Metal stopper = 16/100 Corrected value for moment center position distance A_n: Table (3)</p> <p>$M_{ea} = \gamma \cdot M_{max}$ Allowable moment coefficient γ: Graph (2) Max. allowable moment M_{max}: Table (4)</p> <p>$\alpha_3 = M_e/M_{ea}$</p>	<p>Examine M_p.</p> <p>$M_p = 1/3 \times 3.36 \times 9.8 \times \frac{(20 + 6.8)}{1000} = 0.29$ $W_e = 4/100 \times 0.2 \times 420 = 3.36$ $A_2 = 6.8$ $M_{ep} = 0.7 \times 1.7 = 1.19$ $\gamma = 0.7$ $M_p \text{ max} = 1.7$ $\alpha_3 = 0.29/1.19 = 0.24$</p> <p>Examine M_y.</p> <p>$M_y = 1/3 \times 3.36 \times 9.8 \times \frac{(30 + 10.5)}{1000} = 0.44$ $W_e = 33.6$ $A_1 = 10.5$ $M_{ey} = 1.19$ (Same as M_{ep}) $\alpha_3 = 0.44/1.19 = 0.37$</p>
<p>3-4 Sum of the Load Factors</p> <p>Use is possible if the sum of the load factors does not exceed 1.</p>	<p>$\alpha_1 + \alpha_2 + \alpha_3 < 1$</p>	<p>Can be used based on $\alpha_1 + \alpha_2 + \alpha_3 + \alpha_3' = 0.17 + 0.013 + 0.24 + 0.37 = 0.79 < 1$</p>

Fig. (1) Load Mass: W (kg)

Note) No need to consider this load factor in the case of using perpendicularly in a vertical position.

Fig. (2) Overhang: Ln (mm), Correction Values for Moment Center Distance: An (mm)

Note) Static moment: Moment by gravity Dynamic moment: Moment by stopper collision

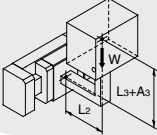
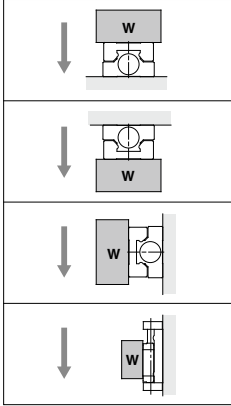
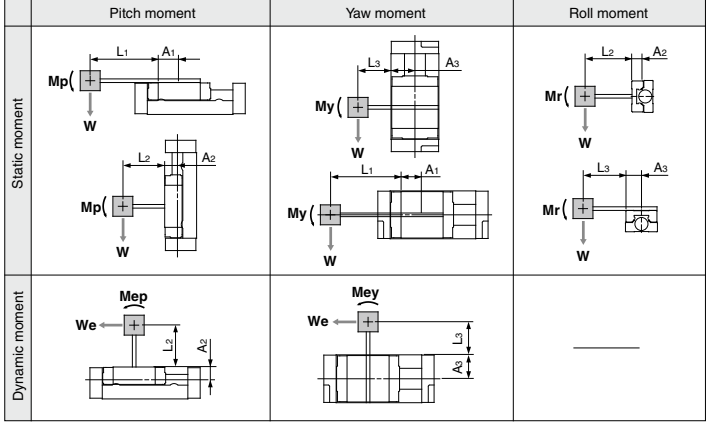
Table (1) Allowable Kinetic Energy: Emax (J)

Model	Allowable kinetic energy		
	Rubber stopper	Shock absorber	Metal stopper
MXPJ6	0.010	—	—
MXP 6	0.010	—	0.005
MXP 8	0.033	—	0.017
MXP10	0.045	0.090	0.023
MXP12	0.076	0.152	0.038
MXP16	0.135	0.270	0.068

Table (2) Max. Allowable Load Mass: Wmax (kg)

Model	Maximum allowable load weight
MXPJ6	0.32
MXP 6	—
MXP 8	0.75
MXP10	1.2
MXP12	1.7
MXP16	3

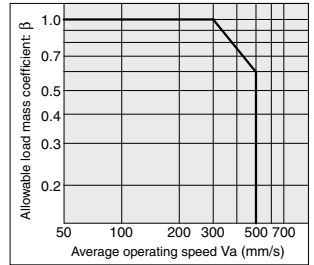
Graph (1) Allowable Load Mass Coefficient: β

Table (3) Moment Center Position Distance Compensation Amount: An (mm)

Model	Stroke	Moment center position distance compensation amount (Refer to Fig. (2).)		
		A ₁	A ₂	A ₃
MXPJ6 MXP 6	5	18.5	5.3	9
	10	23.5		
MXP 8	10	10.5	7.4	11
	20	20.5		
MXP10	10	10.5	6.8	13.5
	20	19.5		
MXP12	15	14.5	8	16
	25	24.5		
MXP16	20	20	12.5	23
	30	28		

Table (4) Maximum Allowable Moment: Mmax (N·m)

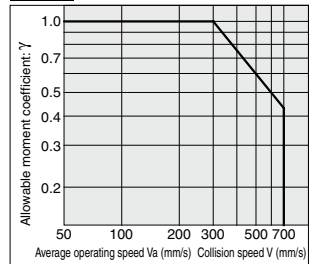
Model	Pitch/Yaw moment: M _{pmax} /M _{ymax}						Roll moment: M _{rmax}					
	Stroke (mm)						Stroke (mm)					
	5	10	15	20	25	30	5	10	15	20	25	30
MXPJ6	1.4	2.3	—	—	—	—	2.6	3.5	—	—	—	—
MXP 6	—	—	—	—	—	—	—	—	—	—	—	—
MXP 8	—	1.4	—	5.7	—	—	—	2.6	—	5.6	—	—
MXP10	—	1.7	—	6.3	—	—	—	4.2	—	8.5	—	—
MXP12	—	—	4.5	—	13	—	—	—	9.8	—	17	—
MXP16	—	—	—	12	—	28	—	—	—	26	—	41

Graph (2) Allowable Moment Coefficient: γ

Note) Use the average operating speed when calculating static moment.
Use the collision speed when calculating dynamic moment.

Symbol

Symbol	Definition	Unit	Symbol	Definition	Unit
An (n = 1 to 3)	Correction values of moment center position distance	mm	V	Collision speed	mm/s
E	Kinetic energy	J	Va	Average operating speed	mm/s
Emax	Allowable kinetic energy	J	W	Load mass	kg
Ln (n = 1 to 3)	Overhang	mm	Wa	Allowable load mass	kg
M (Mp, My, Mr)	Static moment (pitch, yaw, roll)	N·m	We	Mass equivalent to impact	kg
Ma (Map, May, Mar)	Allowable static moment (pitch, yaw, roll)	N·m	Wmax	Max. allowable load mass	kg
Me (Mep, Mey)	Dynamic moment (pitch, yaw)	N·m	α	Load factor	—
Mea (Meap, Meay)	Allowable dynamic moment (pitch, yaw)	N·m	β	Allowable load mass coefficient	—
Mmax (M_{pmax}, M_{ymax}, M_{rmax})	Maximum allowable moment (pitch, yaw, roll)	N·m	γ	Allowable moment coefficient	—

- MXH
- MXS
- MXQ
- MXQ
- MXF
- MXW
- MXJ
- MXP
- MXY
- MTS
- D-□
- X□

Air Slide Table

MXP Series

ø6, ø8, ø10, ø12, ø16



How to Order

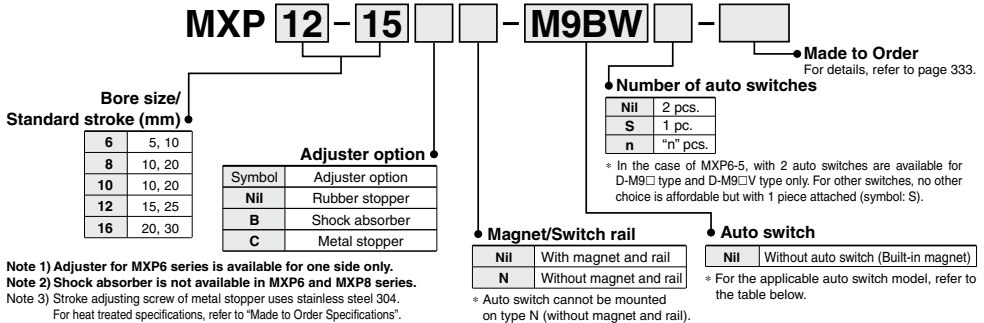

Applicable Auto Switches

Refer to pages 1119 to 1245 for further information on auto switches.

Type	Special function	Electrical entry	Indicator light	Wiring (Output)	Load voltage		Auto switch model		Lead wire length (m)					Pre-wired connector	Applicable load		
					DC	AC	Perpendicular	In-line	0.5 (Nil)	1 (M)	3 (L)	5 (Z)	IC circuit		Relay, PLC		
Solid state auto switch	Diagnostic indication (2-color indicator)	Grommet	Yes	3-wire (NPN)	24 V	5 V, 12 V	—	M9NV	M9N	●	●	●	○	○	—	IC circuit	Relay, PLC
				3-wire (PNP)				M9PV	M9P	●	●	●	○	○			
				2-wire				M9BV	M9B	●	●	●	○	○			
				3-wire (NPN)				M9NWV	M9NW	●	●	●	○	○			
				3-wire (PNP)				M9PWW	M9PW	●	●	●	○	○			
				2-wire				M9BWW	M9BW	●	●	●	○	○			
	Water resistant (2-color indicator)	Grommet	No	3-wire (NPN)	24 V	12 V	—	M9NAV ^{*1}	M9NA ^{*1}	○	○	○	○	○	—	IC circuit	Relay, PLC
				3-wire (PNP)				M9PAV ^{*1}	M9PA ^{*1}	○	○	○	○	○			
				2-wire				M9BAV ^{*1}	M9BA ^{*1}	○	○	○	○	○			
				2-wire				M9BAA ^{*1}	M9BAA ^{*1}	○	○	○	○	○			
Reed auto switch	—	Grommet	Yes	3-wire (NPN equivalent)	24 V	12 V	—	A96V	A96	●	—	—	—	—	IC circuit	—	
				2-wire				A93V ^{*2}	A93	●	●	●	—				—
				2-wire				A90V	A90	●	—	—	—				—

*1 Water resistant type auto switches can be mounted on the above models, but in such case SMC cannot guarantee water resistance.
 *2 1 m type lead wire is only applicable to D-A93.

* Lead wire length symbols: 0.5 m..... Nil (Example) M9NW
 1 m..... M (Example) M9NWM
 3 m..... L (Example) M9NWL
 5 m..... Z (Example) M9NWZ

* Solid state auto switches marked with "○" are produced upon receipt of order.

* Since there are other applicable auto switches than listed, refer to page 347 for details.
 * For details about auto switches with pre-wired connector, refer to pages 1192 and 1193.
 * Auto switches are shipped together (not assembled).

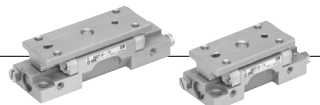

MXPJ6 Air Slide Table ø6

How to Order

MXPJ6 - 10

Standard stroke

5	5 mm
10	10 mm

* MXPJ6 with auto switch is not available.

Specifications

Bore size (mm)	6
Piping port size	M3 x 0.5
Fluid	Air
Action	Double acting
Operating pressure	0.15 to 0.7 MPa
Proof pressure	1.05 MPa
Ambient and fluid temperature	-10 to 60°C
Operating speed range (Average operating speed)	50 to 500 mm/s
Cushion	Rubber bumper
Lubrication	Non-lube
Stroke length tolerance	+1 0 mm

Theoretical Output

Bore size (mm)	Piston area (mm ²)	Operating pressure (MPa)						
		0.2	0.3	0.4	0.5	0.6	0.7	
6	28	6	8	11	14	17	20	

(N)

Stroke

Model	Standard stroke (mm)
MXPJ6	5, 10

Weight

Model	Body weight (g)
MXPJ6-5	80
MXPJ6-10	105

MXP6



MXP8

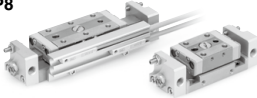

MXP10



MXP12



MXP16



With Shock Absorber

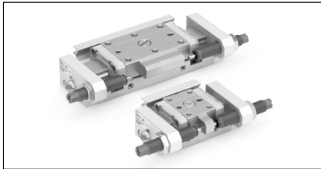

* Exclusive body is to be used for the one with shock absorber. Changing specifications, such as replacing component parts and retrofitting shock absorber is not possible.

Symbol



Made to Order: Individual Specifications
(For details, refer to pages 348 to 350.)

Symbol	Specifications
-X7	PTFE grease
-X9	Grease for food processing machines
-X16	Heat treated metal stopper bolt specification
-X23	Axial piping port set screw specification
-X39	Fluororubber seal
-X42	Anti-rust guide specification
-X45	EPDM seal
-X51	Long adjustment nut specification

For clean room specifications, refer to "Pneumatic Clean Series" catalog (CAT.E02-23).

**Moisture Control Tube
IDK Series**



When operating an actuator with a small diameter and a short stroke at a high frequency, the dew condensation (water droplet) may occur inside the piping depending on the conditions. Simply connecting the moisture control tube to the actuator will prevent dew condensation from occurring. For details, refer to [the IDK series in the Best Pneumatics No. 6](#).

Specifications

Model		MXP6	MXP8	MXP10	MXP12	MXP16
Bore size (mm)		6	8	10	12	16
Piping port size		M3 x 0.5	M5 x 0.8			
Fluid		Air				
Action		Double acting				
Operating pressure		0.15 to 0.7 MPa				
Proof pressure		1.05 MPa				
Ambient and fluid temperature		-10 to 60°C				
Operating speed range (Average operating speed)		50 to 500 mm/s (Adjuster option/Metal stopper: 50 to 200 mm/s)				
Cushion		Rubber bumper Shock absorber (Option is not available for MXP6 and MXP8 series) None (Adjuster option/Metal stopper)				
Lubrication		Non-lube				
Stroke adjuster		Standard equipment (Adjustable on one side only, for the MXP6)				
Stroke adjustment range	Rubber stopper	0 to 5 mm on one side only		Each 0 to 3 mm on both ends		
	Metal stopper	0 to 6 mm on one side only		Each 0 to 5 mm on both ends		Each 0 to 4 mm on both ends
Auto switch		Reed auto switch (2-wire, 3-wire) Solid state auto switch (2-wire, 3-wire) 2-color indicator solid state auto switch (2-wire, 3-wire)				
Stroke length tolerance		+ ₀ mm				

(None) Average operating speed: Speed that the stroke is divided by a period of time from starting the operation to reaching the end.

Theoretical Output

Bore size (mm)	Piston area (mm ²)	Operating pressure (MPa)					
		0.2	0.3	0.4	0.5	0.6	0.7
6	28	6	8	11	14	17	20
8	50	10	15	20	25	30	35
10	79	16	24	32	40	47	55
12	113	23	34	45	57	68	79
16	201	40	60	80	101	121	141

Standard Stroke

Model	Standard stroke (mm)
MXP6	5, 10
MXP8	10, 20
MXP10	10, 20
MXP12	15, 25
MXP16	20, 30

Weight

Model	Body mass (g)		Additional weight of magnet and switch rail
	Rubber bumper Metal stopper	Shock absorber	
MXP6-5	80	—	10
MXP6-10	105	—	10
MXP8-10	100	—	8
MXP8-20	160	—	12
MXP10-10	130	170	13
MXP10-20	210	255	20
MXP12-15	210	250	17
MXP12-25	320	375	23
MXP16-20	640	700	20
MXP16-30	830	905	23

Shock Absorber Specifications

Shock absorber model		RB0805	RB0806
Applicable slide table		MXP10/12	MXP16
Max. energy absorption (J)		0.98	2.94
Stroke absorption (mm)		5	6
Max. collision speed (mm/s)		50 to 500	
Max. operating frequency (cycle/min)		80	80
Max. allowable thrust (N)		245	245
Ambient temperature range (°C)		-10 to 60	
Spring force (N)	Extended	1.96	1.96
	Retracted	3.83	4.22
Weight (g)		15	15

* The shock absorber service life is different from that of the MXP cylinder depending on the operating conditions. Refer to the RB Series Specific Product Precautions for the replacement period.

- MXH
- MXS
- MXQ
- MXQ
- MXF
- MXW
- MXJ
- MXP
- MXY
- MTS

- D-
- X

The graphs below show the table displacement when the static moment load is applied to the table. The graphs do not show the loadable weight. Refer to the Model Selection for the loadable weight.

Table Deflection (Reference Values)

Table displacement due to pitch moment load

Displacement on A when load is applied on F.

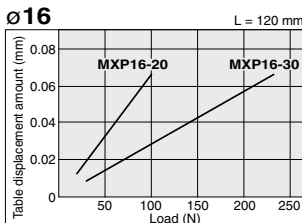
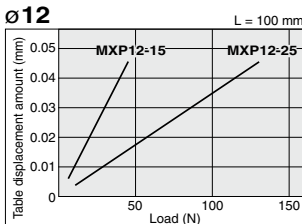
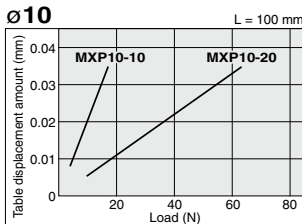
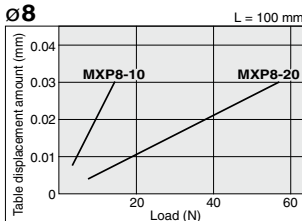
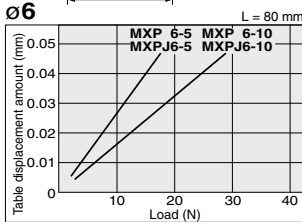
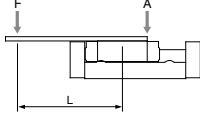

Table displacement due to yaw moment load

Displacement on A when load is applied on F.

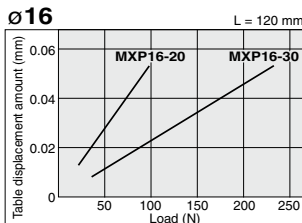
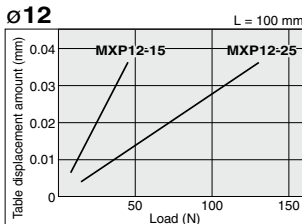
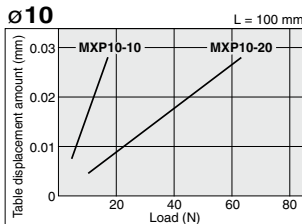
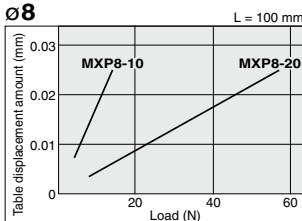
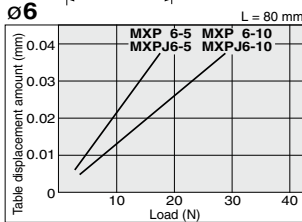
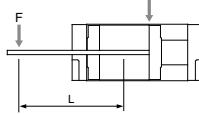

Table displacement due to roll moment load

Displacement on A when load is applied on F.

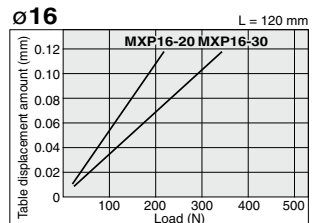
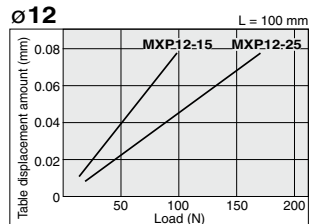
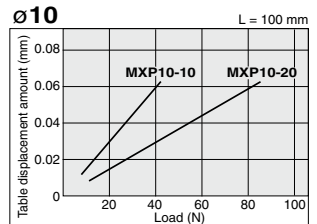
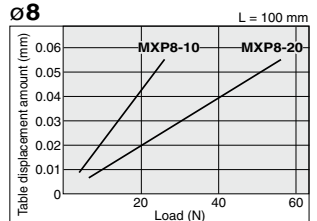
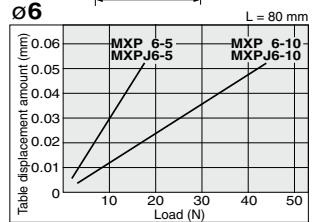
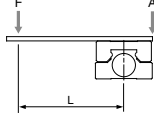
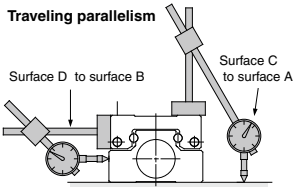
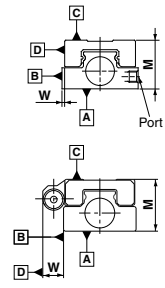
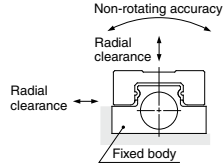

Table Accuracy



The amount of deflection on a dial gauge when the guide block travels a full stroke with the body secured on a reference base surface.



Model	MXPJ6	MXP6	MXP8	MXP10	MXP12	MXP16
Radial clearance (μm)	0 to -2	0 to -2	0 to -3	0 to -3	0 to -5	0 to -7
Table non-rotating accuracy (deg)	0 (Note)					

Note) In theory, non-rotating table accuracy is zero by the preloaded specification. However, in some actual cases, a moment can be applied and can cause deflection in an individual part. Therefore, refer to the table displacement amount on page 334.

With shock absorber

Model	MXPJ6	MXP6	MXP8	MXP10	MXP12	MXP16
Parallelism	Surface C to surface A			0.02		
	Surface D to surface B			0.02		
Traveling parallelism	Surface C to surface A			0.004		
	Surface D to surface B			0.004		
M dimension tolerance	±0.05					
W dimension tolerance	±0.05					

Option Specifications

Rail assembly for mounting auto switch

When auto switch is mounted on air slide table without rail (MXP□-□N), this assembly is used.

Dimensions

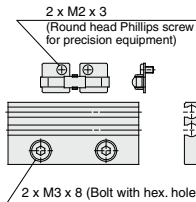

MXP10, 12, 16

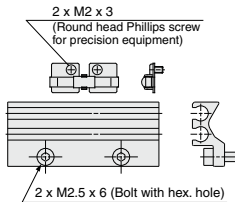

MXP8

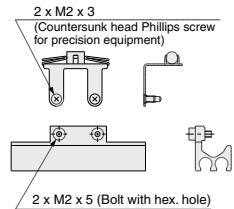

MXP6

Applicable size	Switch rail part no.	Note
MXP6-5	MXP-AD6-5 MXP-AD8-10 MXP-AD8-20 MXP-AD10-10 MXP-AD10-20 MXP-AD12-15 MXP-AD12-25 MXP-AD10-20 MXP-AD12-25	With magnet and mounting screw
MXP6-10		
MXP8-10		
MXP8-20		
MXP10-10		
MXP10-20		
MXP12-15		
MXP12-25		
MXP16-20	MXP-AD10-20	
MXP16-30	MXP-AD12-25	

Note) MXP16-20 and MXP10-20 are common.
MXP16-30 and MXP12-25 are common.

MXH

MXS

MXQ

MXQ

MXF

MXW

MXJ

MXP

MXY

MTS

D-□

-X□

MXP Series

Construction

MXP6

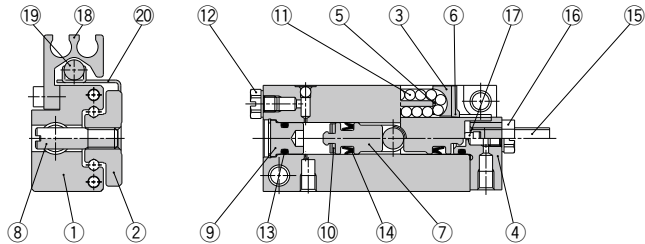

Component Parts

No.	Description	Material	Note
1	Body	Stainless steel	Heat treated
2	Table	Stainless steel	Heat treated
3	Cover	Resin	
4	End plate	Stainless steel	
5	Return guide	Resin	
6	Scraper	Stainless steel, NBR	
7	Piston	Brass	Electroless nickel plated
8	Joint shaft	Carbon steel	Electroless nickel plated
9	End cap	Brass	Electroless nickel plated
10	Rod bumper	Polyurethane	
11	Steel ball	High carbon chrome bearing steel	
12	Plug	Brass, Stainless steel, NBR	Electroless nickel plated

Replacement Parts/ Seal Kit

Bore size (mm)	Kit no.	Contents
6	MXP6-PS	2 pieces of no. 13, 14 and Gasket for 12

Component Parts

No.	Description	Material	Note
13	O-ring	NBR	
14	Piston seal	NBR	
15	Adjustment bolt	Carbon steel (Rubber stopper)	Zinc chromated
		Stainless steel (Metal stopper)	
16	Adjustment nut	Carbon steel	Zinc chromated
17	Adjustment bumper	Polyurethane	None for the metal stopper
18	Switch rail	Aluminum alloy	Hard anodized
19	Magnet	—	Nickel plated
20	Magnet holder	Steel	Nickel plated

Replacement Parts/ Grease Pack

Applied unit	Grease pack part no.
Guide unit	GR-S-010 (10g)
	GR-S-020 (20g)
Cylinder unit	GR-L-005 (5g)
	GR-L-010 (10g)

MXPJ6

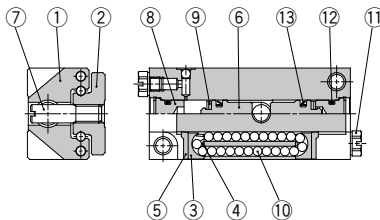

Replacement Parts/ Grease Pack

Applied unit	Grease pack part no.
Guide unit	GR-S-010 (10g)
	GR-S-020 (20g)
Cylinder unit	GR-L-005 (5g)
	GR-L-010 (10g)

Component Parts

No.	Description	Material	Note
1	Body	Stainless steel	Heat treated
2	Table	Stainless steel	Heat treated
3	Cover	Resin	
4	Return guide	Resin	
5	Scraper	Stainless steel, NBR	
6	Piston	Brass	Electroless nickel plated
7	Joint shaft	Carbon steel	Electroless nickel plated
8	End cap	Brass	Electroless nickel plated
9	Rod bumper	Polyurethane	
10	Steel ball	High carbon chrome bearing steel	
11	Plug	Brass, Stainless steel, NBR	Electroless nickel plated
12	O-ring	NBR	
13	Piston seal	NBR	

Replacement Parts/Seal Kit

Bore size (mm)	Kit no.	Contents
6	MXPJ6-PS	2 pieces of no. 12 and 13 and Gasket for 11

MXP8,10,12,16

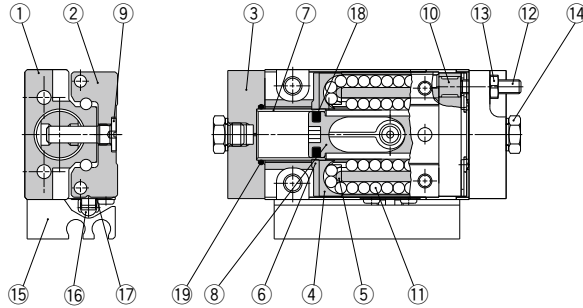

Component Parts

No.	Description	Material	Note
1	Body	Stainless steel	Heat treated
2	Guide block	Stainless steel	Heat treated
3	End plate	Aluminum alloy	Hard anodized
4	Cover	Resin	
5	Return guide	Resin	
6	Scraper	Stainless steel, NBR	
7	Tube	Stainless steel	(Except ø8)
8	Piston	Resin	
9	Joint shaft	Carbon steel	Electroless nickel plated
10	Adjustment bumper	Polyurethane	None for the metal stopper

Replacement Parts/ Seal Kit

Bore size (mm)	Kit no.	Contents
8	MXP8-PS	2 pieces of no.18, 19 and Gasket for 14
10	MXP10-PS	
12	MXP12-PS	
16	MXP16-PS	

Component Parts

No.	Description	Material	Note
11	Steel ball	High carbon chrome bearing steel	
12	Adjustment bolt	Carbon steel (Rubber stopper) Stainless steel (Metal stopper)	Zinc chromated
13	Adjust nut	Carbon steel	Zinc chromated
14	Plug	Brass, Stainless steel, NBR	Electroless nickel plated
15	Switch rail	Aluminum alloy	Hard anodized
16	Magnet	—	Nickel plated
17	Magnet holder	Steel	Electroless nickel plated
18	Piston seal	NBR	
19	O-ring	NBR	

Replacement Parts/ Grease Pack

Applied unit	Grease pack part no.
Guide unit	GR-S-010 (10g)
	GR-S-020 (20g)
Cylinder unit	GR-L-005 (5g)
	GR-L-010 (10g)

- MXH
- MXS
- MXQ
- MXQ
- MXF
- MXW
- MXJ
- MXP
- MXY
- MTS

- D-
- X

MXP Series

Dimensions: MXPJ6

MXPJ6-5

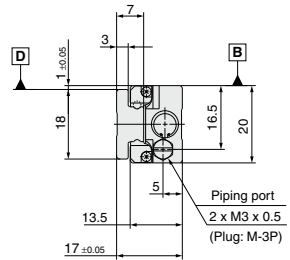
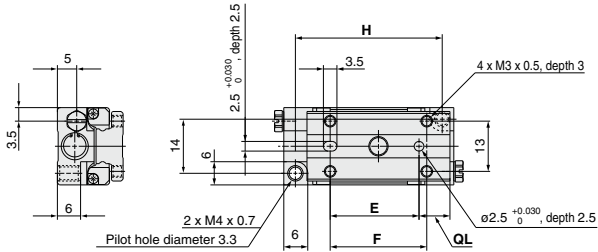

B **D** — Mounting datum level

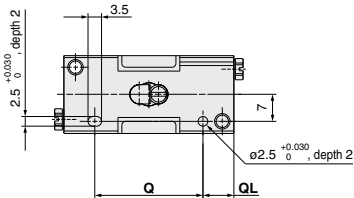
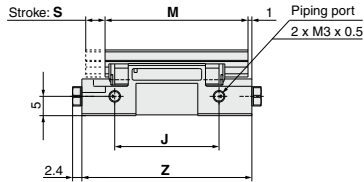

MXPJ6-10

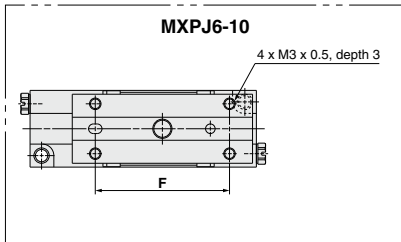

(mm)

Model	E	F	H	J	M	Q	QL	S	Z
MXPJ6-5	23	25	38	27	37	28	8	5	44
MXPJ6-10	30	35	53	42	47	37	11	10	59

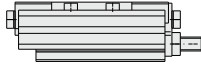

MXP6-5

Note) Since the body and table are made of a magnetic substance, it could become magnetized if touched by a magnet, etc. This could cause auto switch malfunction.

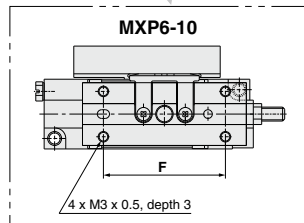
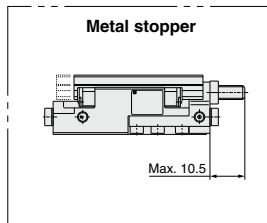
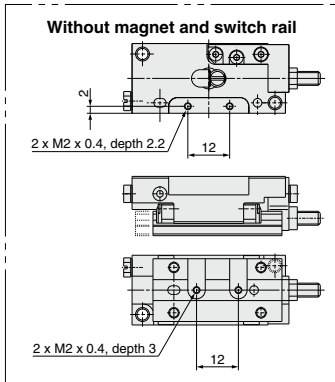
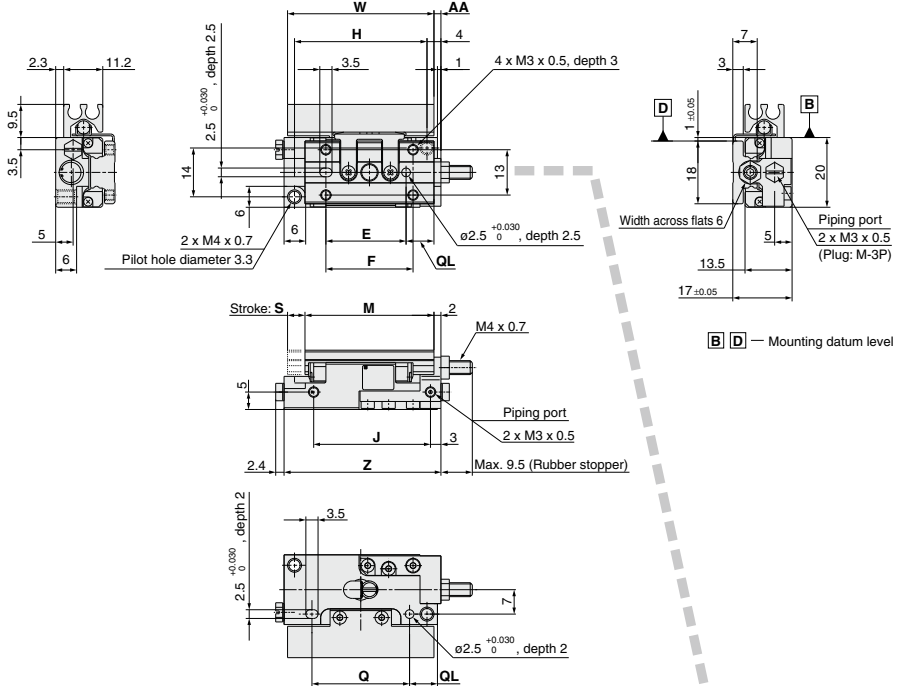

Model	E	F	H	J	M	Q	QL	S	W	Z	AA
MXP6-5	23	25	38	33.5	37	28	8	5	42	45	2
MXP6-10	30	35	53	48.5	47	37	11	10	42	60	9.5

- MXH
- MXS
- MXQ
- MXF
- MXW
- MXJ
- MXP
- MXY
- MTS

MXP Series

Dimensions: MXP8

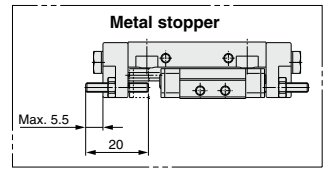
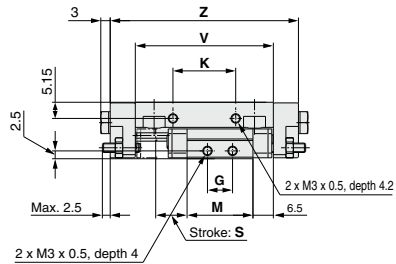

Note) Since the body and table are made of a magnetic substance, it could become magnetized if touched by a magnet, etc. This could cause auto switch malfunction.

MXP8-10

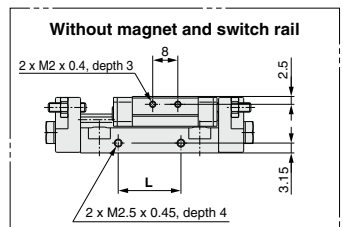
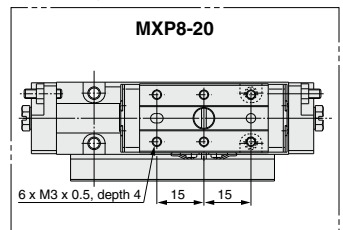
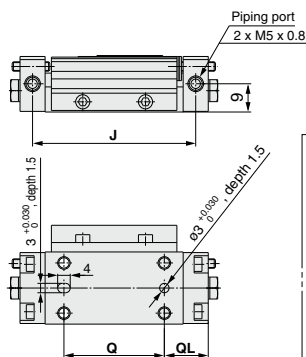
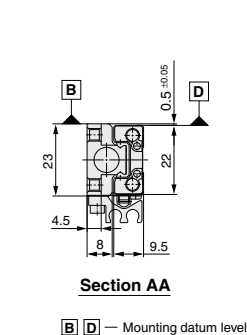
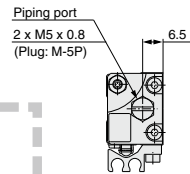
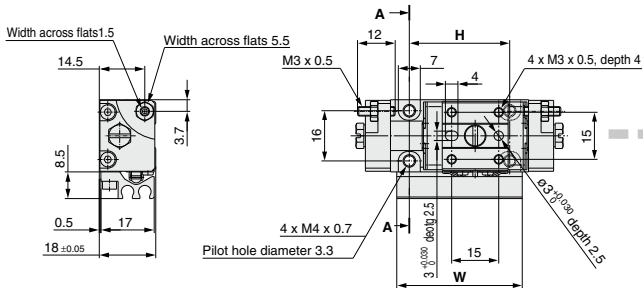

Model	G	H	J	K	L	M	Q	QL	S	V	W	Z
MXP8-10	8	32	52	20	20	21	32	14	10	44	40	60
MXP8-20	20	50	82	36	36	41	50	20	20	74	65	90

Dimensions: MXP10

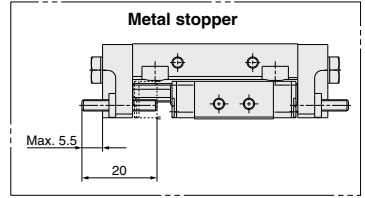
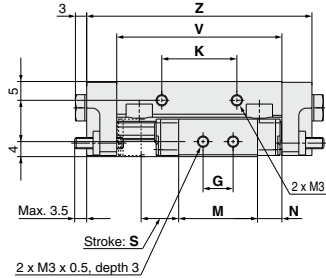

Note) Since the body and table are made of a magnetic substance, it could become magnetized if touched by a magnet, etc. This could cause auto switch malfunction.

MXP10-10

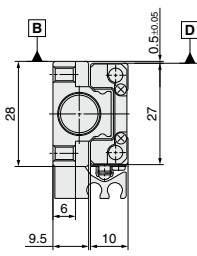
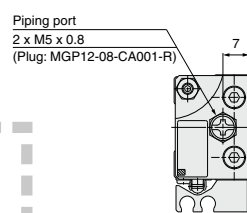
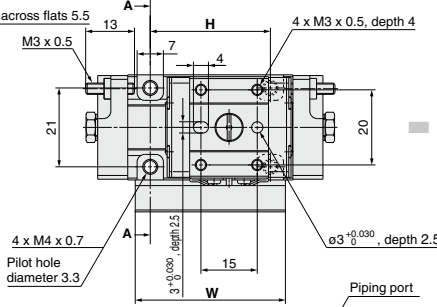
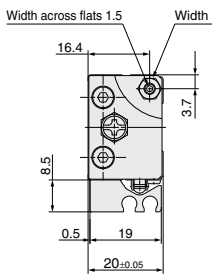

Section AA

B D — Mounting datum level

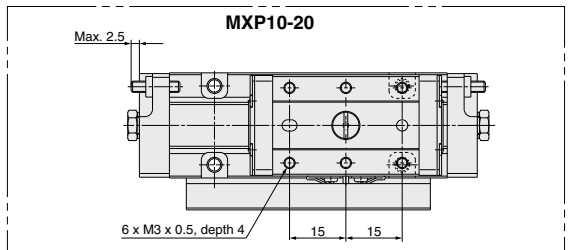
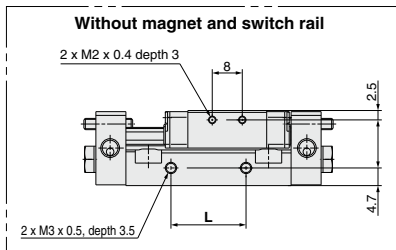
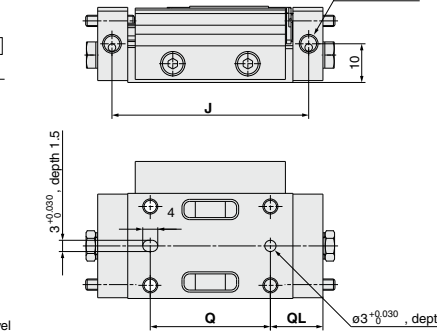

(mm)

Model	G	H	J	K	L	M	N	Q	QL	S	V	W	Z
MXP10-10	8	32	52.4	20	20	21	6.5	32	14	10	44	40	60
MXP10-20	20	50	82.4	36	36	39	7.5	50	20	20	74	65	90

- MXH
- MXS
- MXQ
- MXF
- MXW
- MXJ
- MXP
- MXY
- MTS

- D-
- X

MXP Series

Dimensions: MXP10 with Shock Absorber

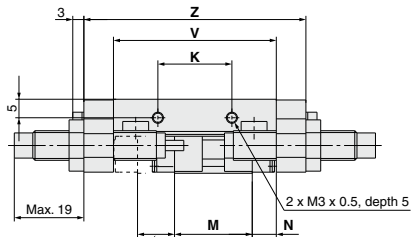

Note) Since the body and table are made of a magnetic substance, it could become magnetized if touched by a magnet, etc. This could cause auto switch malfunction.

Stroke: S **MXP10-10B**

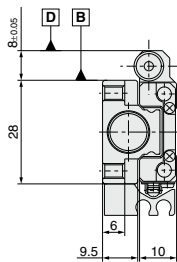
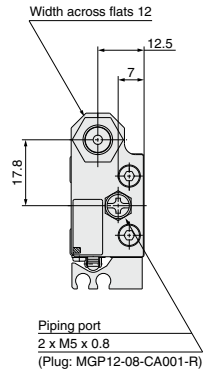
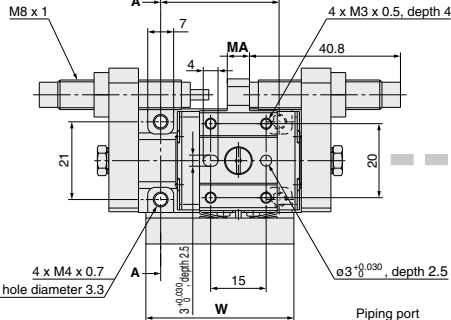
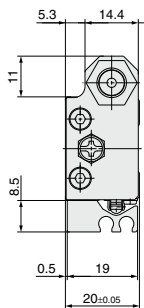

Section AA

B **D** — Mounting datum level

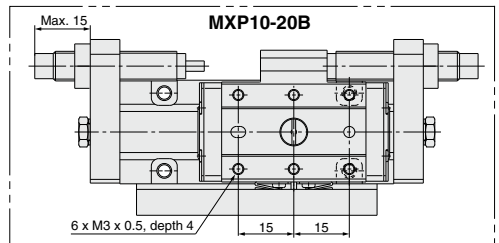
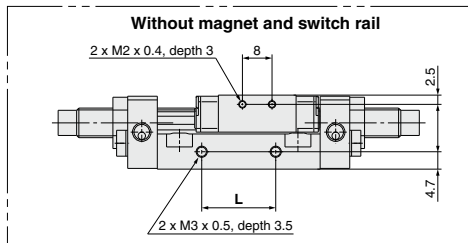
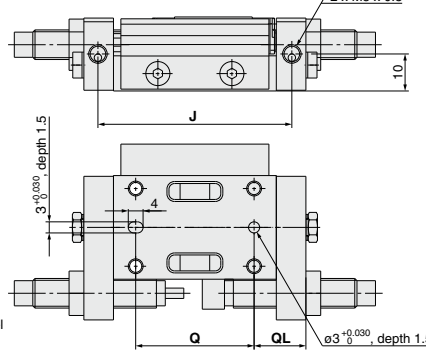

(mm)

Model	H	J	K	L	M	MA	N	Q	QL	S	V	W	Z
MXP10-10B	32	52.4	20	20	21	6	6.5	32	14	10	44	40	60
MXP10-20B	50	82.4	36	36	39	18	7.5	50	20	20	74	65	90

Dimensions: MXP12

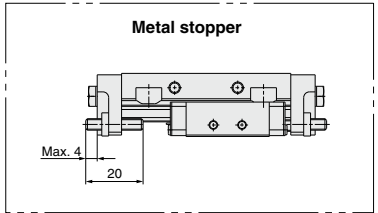
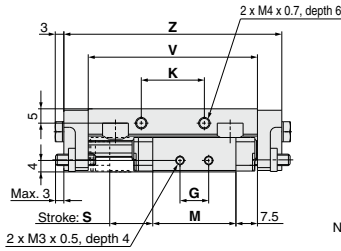

Note) Since the body and table are made of a magnetic substance, it could become magnetized if touched by a magnet, etc. This could cause auto switch malfunction.

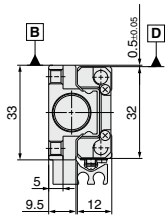
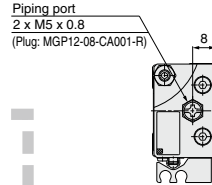
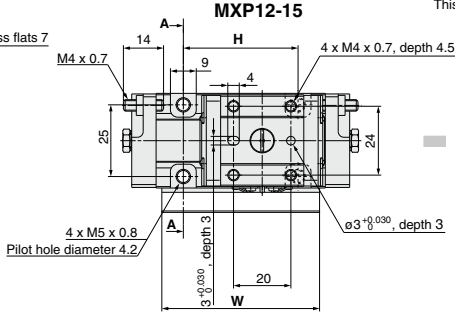
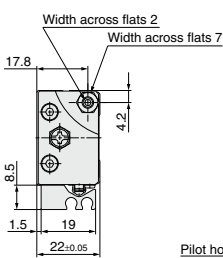

Section AA

B **D** — Mounting datum level

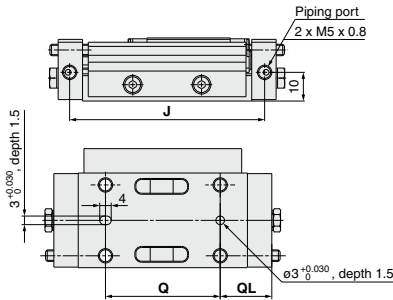

MXP12-25

Without magnet and switch rail

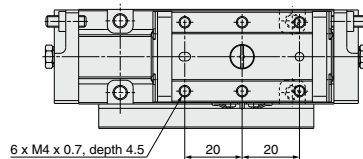
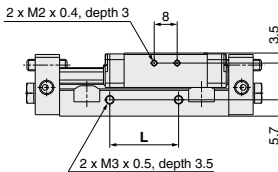

(mm)

Model	G	H	J	K	L	M	Q	QL	S	V	W	Z
MXP12-15	10	40	68	22	24	29	40	18	15	59	55	76
MXP12-25	30	60	98	40	42	49	60	23	25	89	75	106

- MXH
- MXS
- MXQ
- MXQ
- MXF
- MXW
- MXJ
- MXP**
- MXY
- MTS

- D-□
- X□

MXP Series

Dimensions: MXP12 with Shock Absorber

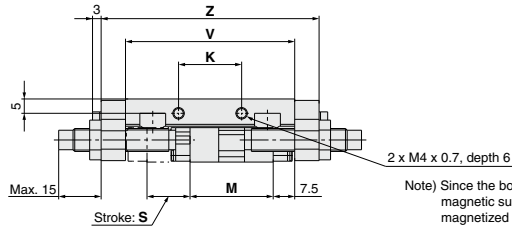

Note) Since the body and table are made of a magnetic substance, it could become magnetized if touched by a magnet, etc. This could cause auto switch malfunction.

MXP12-15B

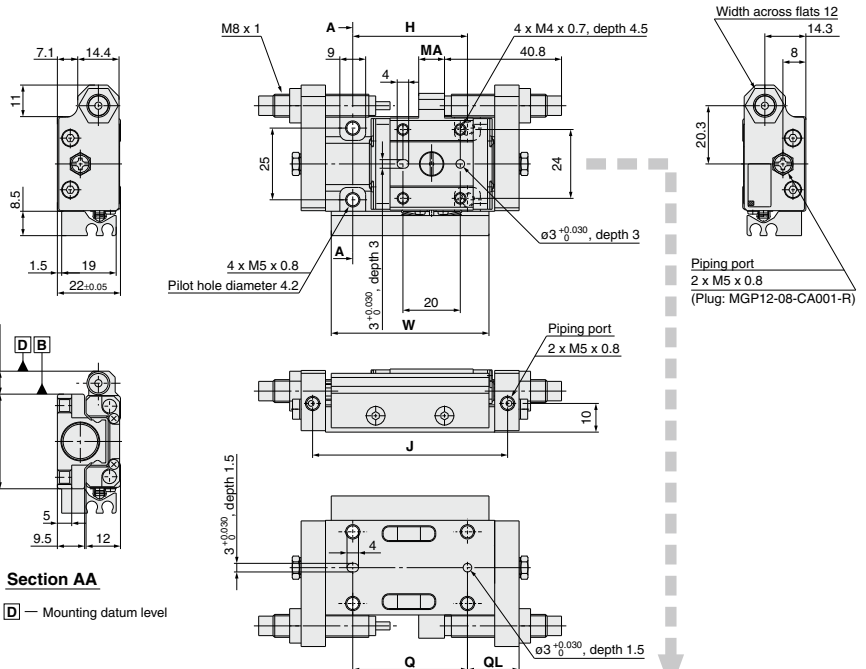

Section AA

B **D** — Mounting datum level

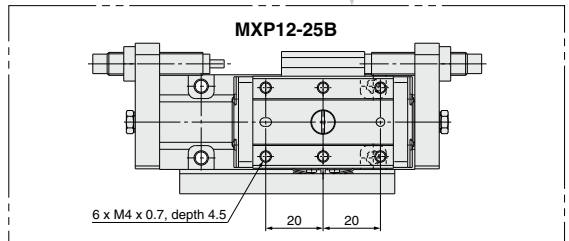
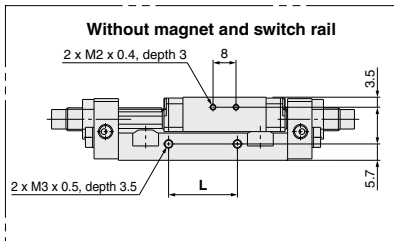

Model	H	J	K	L	M	MA	Q	QL	S	V	W	Z
MXP12-15B	40	68	22	24	29	9	40	18	15	59	55	76
MXP12-25B	60	98	40	42	49	29	60	23	25	89	75	106

Dimensions: MXP16

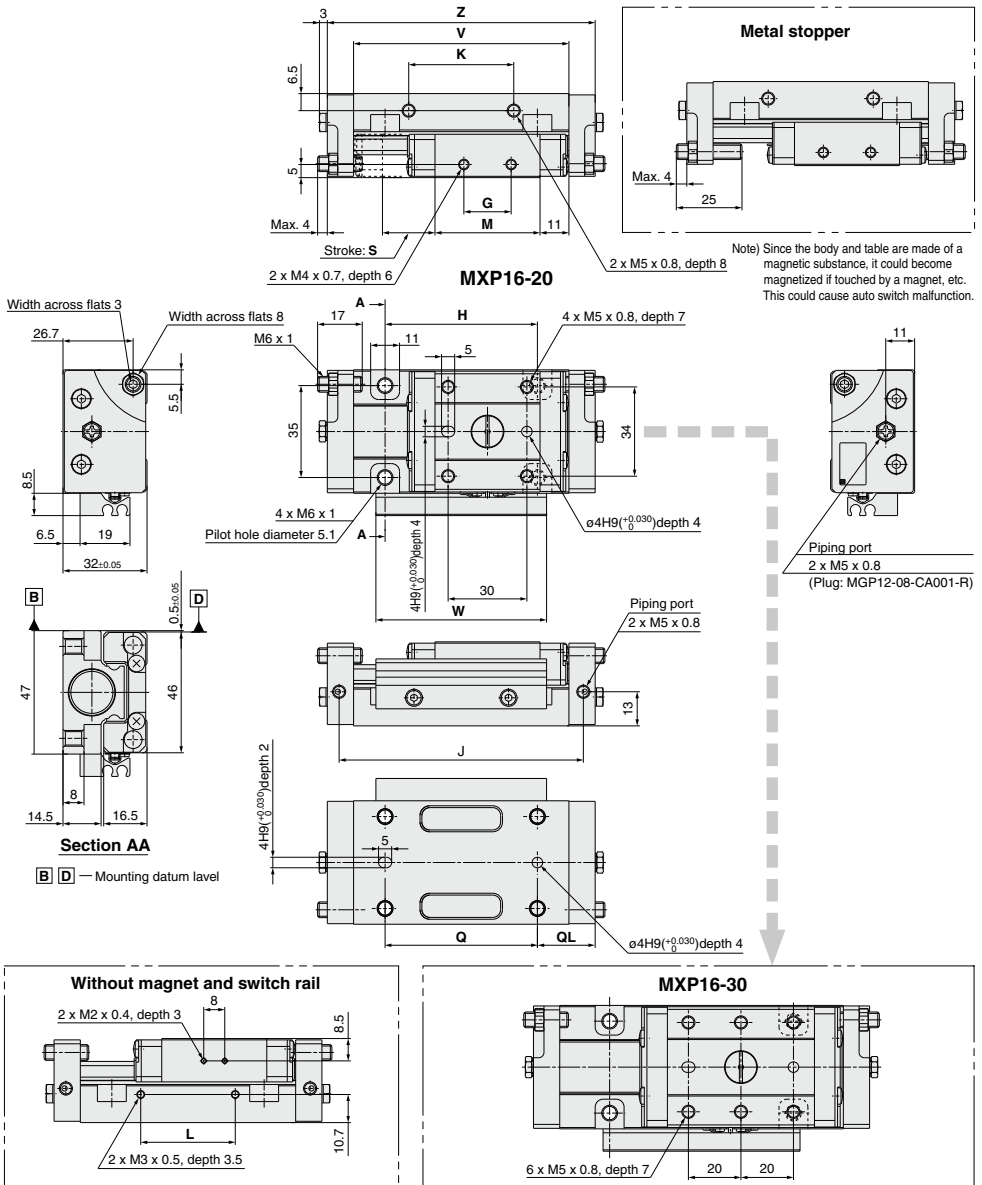

- MXH
- MXS
- MXQ
- MXQ
- MXF
- MXW
- MXP
- MXY
- MTS

Model	G	H	J	K	L	M	Q	QL	S	V	W	Z
MXP16-20	18	58	93	40	36	40	58	22	20	82	65	102
MXP16-30	28	70	119	50	42	56	70	29	30	108	75	128

- D
- X

MXP Series

Dimensions: MXP16 with Shock Absorber

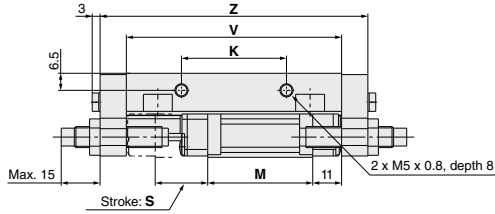

Note) Since the body and table are made of a magnetic substance, it could become magnetized if touched by a magnet, etc. This could cause auto switch malfunction.

MXP16-20B

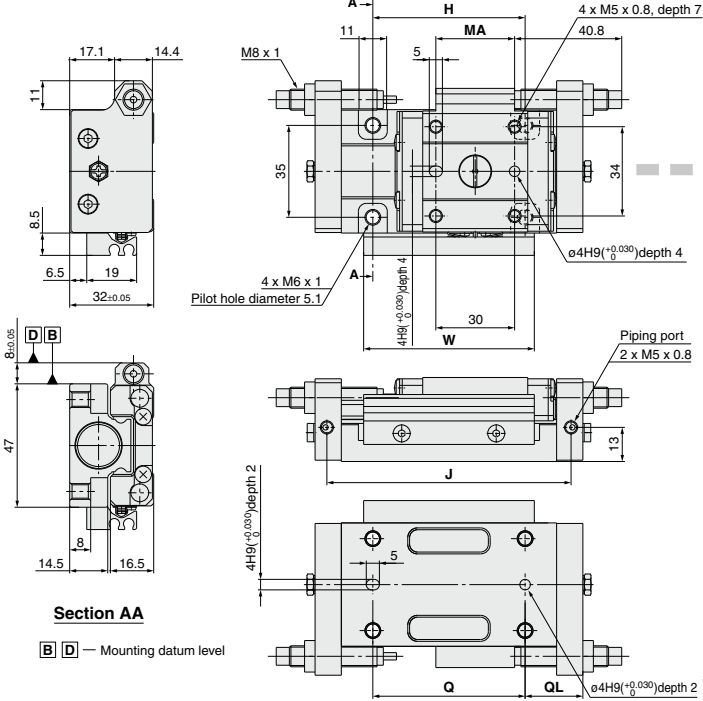

Without magnet and switch rail

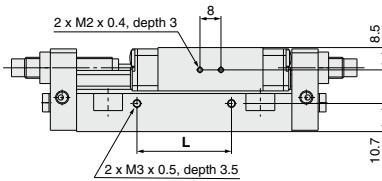

MXP16-30B

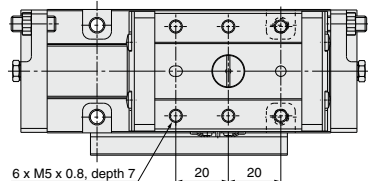

(mm)

Model	H	J	K	L	M	MA	Q	QL	S	V	W	Z
MXP16-20B	58	93	40	36	40	30	58	22	20	82	65	102
MXP16-30B	70	119	50	42	56	46	70	29	30	108	75	128

Auto Switch Mounting

Auto Switch Proper Mounting Position (Detection at Stroke End)

MXP8,10,12,16

- Electrical entry from outside

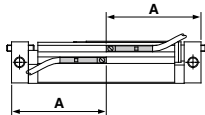

- Electrical entry from inside

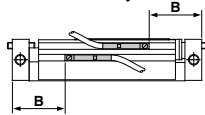

- Parallel electrical entry

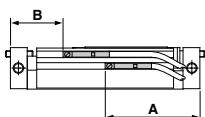

MXP6

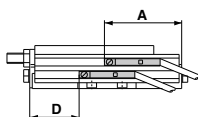
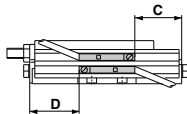
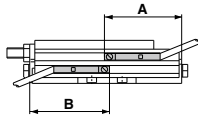

Reed Auto Switch

D-A90(V), D-A93(V), D-A96(V) (mm)

Model	Stroke (mm)					
	10	15	20	25	30	
MXP8	A	35	—	45	—	—
	B	15	—	25	—	—
MXP10	A	35	—	45	—	—
	B	15	—	25	—	—
MXP12	A	—	40.5	—	50.5	—
	B	—	20.5	—	30.5	—
MXP16	A	—	—	51	—	59
	B	—	—	31	—	39

Solid State Auto Switch

D-M9B(V), D-M9N(V), D-M9P(V) (mm)

Model	Stroke (mm)					
	10	15	20	25	30	
MXP8	A	31	—	41	—	—
	B	19	—	29	—	—
MXP10	A	31	—	41	—	—
	B	19	—	29	—	—
MXP12	A	—	36.5	—	46.5	—
	B	—	24.5	—	34.5	—
MXP16	A	—	—	47	—	55
	B	—	—	35	—	43

2-Color Indicator, Solid State Auto Switch

D-M9BW(V), D-M9NW(V), D-M9PW(V), D-M9A(V) (mm)

Model	Stroke (mm)					
	10	15	20	25	30	
MXP8	A	31	—	41	—	—
	B	19	—	29	—	—
MXP10	A	31	—	41	—	—
	B	19	—	29	—	—
MXP12	A	—	36.5	—	46.5	—
	B	—	24.5	—	34.5	—
MXP16	A	—	—	47	—	55
	B	—	—	35	—	43

Note) Adjust the auto switch after confirming the operating conditions in the actual setting.

Reed Auto Switch

D-A90(V), D-A93(V), D-A96(V)

Model	Stroke (mm)	
	A	B
MXP6	A	10
	B	34.5
	C	14.5
	D	15.5

Solid State Auto Switch

D-M9B(V), D-M9N(V), D-M9P(V)

Model	Stroke (mm)	
	5	10
MXP6	A	25.5 30.5
	B	26.5 31.5
	C	13.5 18.5
	D	14.5 19.5

2-Color Indicator, Solid State Auto Switch

D-M9BW(V), D-M9NW(V),

D-M9PW(V), D-M9A(V)

Model	Stroke (mm)	
	5	10
MXP6	A	25.5 30.5
	B	26.5 31.5
	C	13.5 18.5
	D	14.5 19.5

Operating Range

Auto switch model	Applicable bore size (mm)				
	6	8	10	12	16
D-A9□/A9□V	5	5	5	5	5
D-M9□/M9□V	—	—	—	—	—
D-M9□W/M9□WV	3	3	3.5	3	3
D-M9□A/M9□AV	—	—	—	—	—

Minimum Auto Switch Mounting Stroke

No. of auto switches mounted	Applicable auto switch model (mm)		
	D-A9□ D-A9□V	D-M9□ D-M9□V	D-M9□W D-M9□WV D-M9□AV
1 pc.	5	5	5
2 pcs.	10	5	10

Auto Switch Mounting

⚠ Caution

Auto Switch Mounting Tool

- Use the watchmaker's screwdriver with a handle diameter 5 to 6 mm when tightening the auto switch mounting screw (attached to auto switch).

Tightening Torque

Tightening Torque of Auto Switch Mounting Screw (N·m)

Auto switch model	Tightening torque
D-A9□(V)	0.10 to 0.20
D-M9□(V) D-M9□W(V)	0.05 to 0.15
D-M9□A(V)	0.05 to 0.10

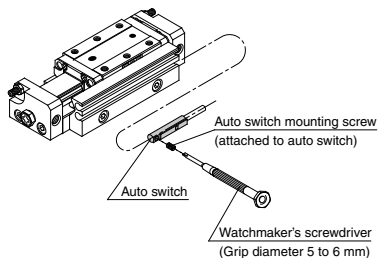

Other than the applicable auto switches listed in "How to Order", the following auto switches can be mounted.

- * Normally closed (NC = b contact) solid state auto switches (D-M9□E(V)) and a solid state auto switch (D-F8) are also available. Refer to pages 1136 and 1592-1 for details.

MXH

MXS

MXQ□

MXQ

MXF

MXW

MXJ

MXP

MXY

MTS

D-□

-X□



1 PTFE Grease Symbol -X7

MXP Standard part no. — X7

MXPJ Standard part no. — X7

● PTFE grease

PTFE grease is used for all parts that grease is applied.

Specifications

Type	PTFE grease
Bore size (mm)	6, 8, 10, 12, 16

* Dimensions other than the above is the same as the standard type.

Warning Precautions

Be aware that smoking cigarettes, etc. after your hands have come into contact with the grease used in this cylinder can create a gas that is hazardous to humans.

2 Grease for Food Processing Machines Symbol -X9

MXP Standard part no. — X9

MXPJ Standard part no. — X9

● Grease for food processing machines

Grease for food processing machines is used for all parts that grease is applied.

Specifications

Type	Grease for Food Processing Machines (NSF-H1 certified) Aluminum Complex Soap Base Grease
Bore size (mm)	6, 8, 10, 12, 16

* Dimensions other than the above is the same as the standard type.

Caution

Do not use the cylinders in a food-related environment.

<Cannot be mounted>
Food zone.....Food may directly contact with cylinders, and is treated as food products.
<Can be mounted>
Splash zone.....Food may directly contact with cylinders, but is not treated as food products.
Non-food zone.....Air grippers do not directly contact food.

3 Heat Treated Metal Stopper Bolt Symbol -X16

MXP Standard part no. — X16

● Heat treated metal stopper bolt

To reduce wear on the metal stopper, heat treated chrome molybdenum steel (SCM435) is used for the stroke adjustment screw.

Specifications

Type	Heat treated metal stopper bolt		
Bore size (mm)	6	8, 10	12, 16
Speed range	50 to 200 mm/s		
Cushion	None		
Stroke adjustment	Singe end: 0 to 6 mm	Double ends: 0 to 5 mm each	Double ends: 0 to 4 mm each

* Dimensions other than the above is the same as the standard type.

4 Fluororubber Seal Symbol -X39

MXP Standard part no. — X39

MXPJ Standard part no. — X39

● Fluororubber seal

Change the materials for the piston seal, O-rings and scrapers (rubber lined parts) to fluororubber.

Specifications

Type	Fluororubber seal
Bore size (mm)	6, 8, 10, 12, 16
Seal material	Fluororubber

* Dimensions other than the above is the same as the standard type.

5 Anti-corrosive Specifications for Guide Unit Symbol -X42

MXP Standard part no. — X42

MXPJ Standard part no. — X42

● Anti-corrosive specifications for guide unit

Martensitic stainless steel is used for the table, body and guide block. Use this treatment if more effective anti-corrosive measures are necessary.
Anti-corrosive treatment is applied to the table, body and guide block.

Specifications

Type	Anti-corrosive guide unit
Bore size (mm)	6, 8, 10, 12, 16
Surface treatment	Special anti-corrosive treatment (2)

* 1 Dimensions other than the above is the same as the standard type.

* 2 The special anti-corrosive treatment turns the table, body and guide block black.



6 EPDM Seal

Symbol
-X45

MXP — X45

MXPJ — X45

● EPDM seal

Change the materials for the piston seal, rod seal, O-rings and scrapers (rubber lined parts) to EPDM.

Specifications

Type	EPDM seal
Bore size (mm)	6, 8, 10, 12, 16
Seal material	EPDM
Grease	PTFE grease

* Dimensions other than the above is the same as the standard type.

Made-to-Order Application Chart		MXPJ6	MXP6	MXP8	MXP10	MXP12	MXP16	Note
PTFE grease	X7	●	●	●	●	●	●	
Grease for food	X9	●	●	●	●	●	●	
Heat treated metal stopper bolt	X16		●	●	●	●	●	Metal stopper only
Axial piping port set screw	X23	●	●	●	●	●	●	
Fluororubber seal	X39	●	●	●	●	●	●	
Anti-corrosive Specifications for Guide Unit	X42	●	●	●	●	●	●	
EPDM seal	X45	●	●	●	●	●	●	
Long adjustment nut	X51			●	●	●	●	Except with shock absorber

Warning Precautions

Be aware that smoking cigarettes, etc. after your hands have come into contact with the grease used in this cylinder can create a gas that is hazardous to humans.

MXH

MXS

MXQ

MXQ

MXF

MXW

MXJ

MXP

MXY

MTS

D-

-X

7 Axial Piping Port Set Screw Specification

Symbol
-X23

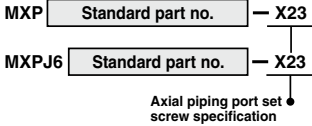

The axial piping port plug (M-3P, M-5P) is changed to a hexagon socket head set screw, and the overall length is shortened.

Note: The hexagon socket head screw is secured with an anaerobic adhesive and cannot be removed.

Dimensions

MXPJ6

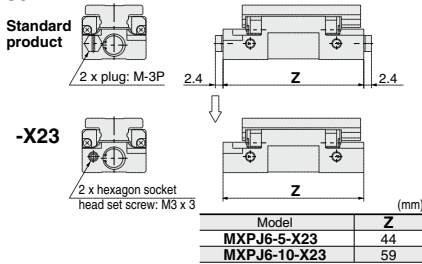

MXP6

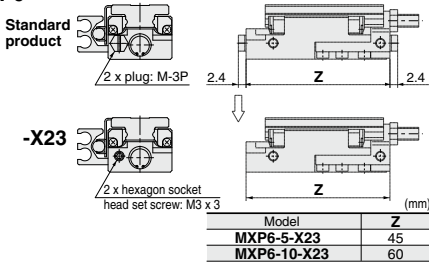

MXP8,10,12,16

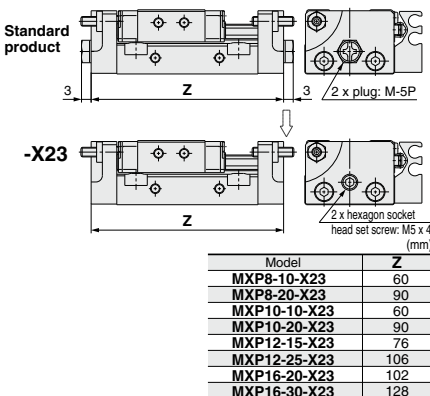

8 Long Adjustment Nut Specification

Symbol
-X51

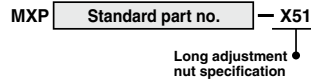

The overall length of the adjustment nut is increased to allow stroke adjustment work from any direction.

Dimensions

MXP8, 10, 12, 16

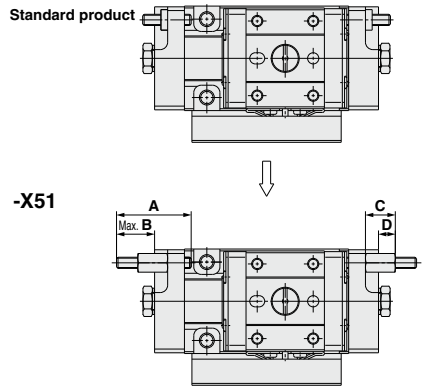

Model	A	B	C	D
MXP8-□-X51	20	10.5		
MXP8-□-C-X51	25	10.5	8	4.5
MXP10-□-X51	20	10.5		
MXP10-□-C-X51	25	10.5	8	4.5
MXP12-□-X51	20	9		
MXP12-□-C-X51	25	9	9	5
MXP16-□-X51	25	12		
MXP16-□-C-X51	35	14	10	6



MXP Series

Specific Product Precautions 1

Be sure to read this before handling the products.

Refer to back page 50 for Safety Instructions and pages 3 to 12 for Actuator and Auto Switch Precautions.

Selection

⚠ Caution

1. Use a load within a range that does not exceed the operating limit.

Select models based on the maximum load mass and the allowable moment. Refer to model selection on pages 330 and 331 for detailed methods. If operated beyond the operating limit, the eccentric load applied to the guide section will be excessive. This can have an adverse effect on service life due to vibration in the guide unit and loss of accuracy, etc.

2. When performing intermediate stops with an external stopper, employ measures to prevent lurching.

If lurching occurs damage can result. When making a stop with an external stopper to be followed by continued forward movement, first supply pressure to momentarily reverse the table, then retract the intermediate stopper, and finally apply pressure to the opposite port to operate the table again.

3. Do not operate in such a way that excessive external forces or impact forces are applied to the product.

This can cause damage.

Mounting

⚠ Caution

1. Do not scratch or gouge the mounting surfaces of the body and table (guide block).

This can cause loss of parallelism in the mounting surfaces, vibration of the guide unit and increased operating resistance, etc.

2. Do not scratch or gouge the transfer surfaces of the body and table (guide block).

This can cause vibration and increased operating resistance, etc.

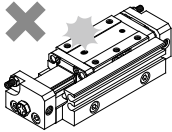

3. Do not apply strong impacts or excessive moment when mounting work pieces.

Application of external forces greater than the allowable moment can cause vibration of the guide unit and increased operating resistance, etc.

4. Ensure that the parallelism of the mounting surface is 0.02 mm or less.

Poor parallelism of the workpiece mounted on the body, the base, and other parts can cause vibration of the guide unit and increased operating resistance, etc.

5. For connection to a load that has an external support or guide mechanism, select an appropriate connection method and perform careful alignment.

Mounting

6. Do not allow objects affected by magnets in close proximity to the air slide table

Since magnets are built into the side of the guide block when equipped with auto switches, do not allow items such as magnetic disks, magnetic cards or magnetic tape close to the air slide table. Data may be erased.

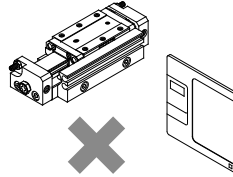

7. Do not attach magnets to the table (guide block) section.

Since the table (guide block) is constructed with a magnetic substance, it becomes magnetized when magnets, etc. are attached to it, and this may cause malfunction of auto switches, etc.

8. When mounting a body, use screws of an appropriate length and tighten them properly at no more than the maximum tightening torque.

Tightening with a torque above the limit can cause malfunction, while insufficient tightening can cause slippage and dropping, etc.

1. Body Tapped

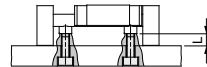

Model	Bolt	Max. tightening torque N·m	Max. screw-in depth L (mm)
MXPJ6	M4 x 0.7	2.1	6
MXP6	M4 x 0.7	2.1	6
MXP8	M4 x 0.7	2.1	4.5
MXP10	M4 x 0.7	2.1	6
MXP12	M5 x 0.8	4.4	5
MXP16	M6 x 1	7.4	8

2. Body Through-hole

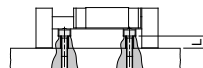

Model	Bolt	Max. tightening torque N·m	Body thickness L (mm)
MXPJ6	M3 x 0.5	1.2	6
MXP6	M3 x 0.5	1.2	6
MXP8	M3 x 0.5	1.2	4.5
MXP10	M3 x 0.5	1.2	6
MXP12	M4 x 0.7	2.1	5
MXP16	M5 x 0.8	4.4	8

MXH

MXS

MXQ

MXQ

MXF

MXW

MXJ

MXP

MXV

MTS

D-□

-X□



MXP Series

Specific Product Precautions 2

Be sure to read this before handling the products.

Refer to back page 50 for Safety Instructions and pages 3 to 12 for Actuator and Auto Switch Precautions.

Mounting

⚠ Caution

3. Tapped on Body Side

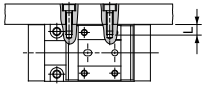

Model	Bolt	Max. tightening torque N·m	Max. screw-in depth L (mm)
MXP8	M3 x 0.5	1.2	4
MXP10	M3 x 0.5	1.2	5
MXP12	M4 x 0.7	2.1	6
MXP16	M5 x 0.8	4.4	8

1. Top Mounting

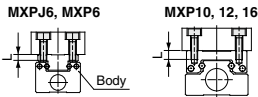

Model	Bolt	Max. tightening torque N·m	Max. screw-in depth L (mm)
MXPJ6	M3 x 0.5	1.2	3
MXP6	M3 x 0.5	1.2	3
MXP8	M3 x 0.5	1.2	4
MXP10	M3 x 0.5	1.2	4
MXP12	M4 x 0.7	2.1	4.5
MXP16	M5 x 0.8	4.4	7

⚠ Caution

Since the bolts pass through in the case of MXPJ6 and MXP6, use bolts shorter than the maximum screw-in depth. If long bolts are used, they can touch the body and cause trouble.

2. Side Mounting

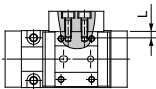

Model	Bolt	Max. tightening torque N·m	Max. screw-in depth L (mm)
MXP8	M3 x 0.5	1.2	4
MXP10	M3 x 0.5	1.2	3
MXP12	M3 x 0.5	1.2	4
MXP16	M4 x 0.7	2.1	6

⚠ Caution

Side mounting is not possible when equipped with shock absorber.

Mounting

9. When the positioning pinhole is used for mounting a body, select a positioning pin with an appropriate length.

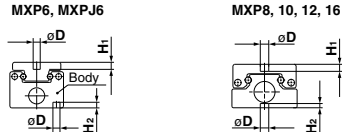

Model	Pinhole diameter	Pinhole depth	
	øD	H1mm	H2mm
MXPJ6	2.5 ^{+0.030} ₀	2.5	2
MXP6	2.5 ^{+0.030} ₀	2.5	2
MXP8	3 ^{+0.030} ₀	2.5	1.5
MXP10	3 ^{+0.030} ₀	2.5	1.5
MXP12	3 ^{+0.030} ₀	3	1.5
MXP16	4H9 ^{+0.030} _g	4	2

Operating Environment

⚠ Caution

1. Do not use in environments where there is direct exposure to liquids such as cutting oil.

Operation in environments where the body is exposed to cutting oil, coolant or oil mist can cause vibration, increased operating resistance and air leakage, etc.

2. Do not use in environments where there is direct exposure to foreign matter such as dust, dirt, chips and spatter.

This can cause vibration, increased operating resistance and air leakage, etc. Consult with SMC regarding use in this kind of environment.

3. Be careful about the corrosion resistance of the linear guide.

Be careful the rail and guide block use martensitic stainless steel, which is inferior to austenitic stainless steel in terms of corrosion resistance.

Adjuster Option Handling Precautions

With Shock Absorber

⚠ Caution

1. Never turn the screw on the bottom of the shock absorber body.

This is not an adjustment screw. Turning it can cause oil leakage.

2. Do not scratch the sliding surface of the shock absorber's piston rod.

This can cause a loss of durability and return malfunction.

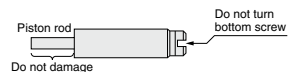



MXP Series

Specific Product Precautions 3

Be sure to read this before handling the products.

Refer to back page 50 for Safety Instructions and pages 3 to 12 for Actuator and Auto Switch Precautions.

Adjuster Option Handling Precautions

⚠ Caution

3. Use the tightening torque in the table below for the shock absorber's lock nut.

Bolt	Tightening torque N·m
MXP10	1.67
MXP12	
MXP16	

Rust may occur specifically in an environment where water drops from condensation adhere to a surface.

4. Provide shade in locations exposed to direct sunlight.

5. Block off sources of heat located near by.

When there are heat sources in the surrounding area, radiated heat may cause the product's temperature to rise and exceed the operating temperature range. Block off the heat with a cover, etc.

6. Do not use in locations where vibration or impact occur.

Consult with SMC regarding use in this kind of environment, as damage and malfunction can result.

Service Life and Replacement Period of Shock Absorber

⚠ Caution

1. Allowable operating cycle under the specifications set in this catalog is shown below.

1.2 million cycles RB08□□

(Note) Specified service life (suitable replacement period) is the value at room temperature (20 to 25°C). The period may vary depending on the temperature and other conditions. In some cases the absorber may need to be replaced before the allowable operating cycle above.

Applicable size	Shock absorber model
MXP10	RB0805
MXP12	RB0805
MXP16	RB0806

Stroke Adjustment

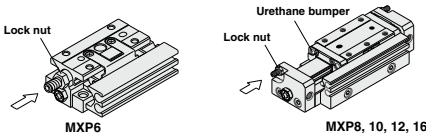

Loosen the lock nut, adjust the stroke with a hexagon wrench from the side marked with an arrow and secure with the lock nut.

Stroke Adjustment

⚠ Caution

Urethane Bumper

If not adjusted for effective operation of the urethane bumper, impact will increase and have an adverse effect on service life. As a guide, adjust so that dimension L₁ is less than the value shown in "Table 1".

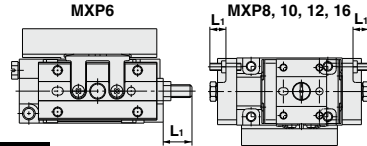

Table 1

Model	L ₁ (mm)
MXP6-5	9 (one side only)
MXP6-10	9 (one side only)
MXP8-10	7
MXP8-20	6
MXP10-10	7
MXP10-20	6
MXP12-15	7
MXP12-25	7
MXP16-20	8
MXP16-30	8

Metal Stopper

In the case of a metal stopper, adjust so that the stroke adjuster hits the end face of the guide block.

As a guide, adjust so that dimension L₂ is less than the value shown in "Table 2".

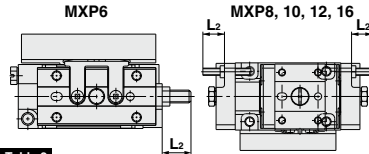

Table 2

Model	L ₂ (mm)
MXP6-5C	10 (one side only)
MXP6-10C	10 (one side only)
MXP8-10C	9
MXP8-20C	8
MXP10-10C	9
MXP10-20C	8
MXP12-15C	8
MXP12-25C	8
MXP16-20C	8
MXP16-30C	8

Shock Absorber

When equipped with shock absorber, adjust so that the end face of the shock absorber hits the guide block. If the shock absorber does not operate effectively, impact will increase and have an adverse effect on service life. As a guide, adjust so that dimension L₃ is less than the value shown in "Table 3".

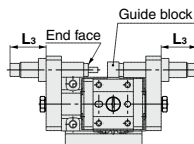

Table 3

Model	L ₃ (mm)
MXP10-10B	19
MXP10-20B	15
MXP12-15B	15
MXP12-25B	15
MXP16-20B	15
MXP16-30B	15

MXH

MXS

MXQ

MXQ

MXF

MXW

MXJ

MXP

MXY

MTS

D-□

-X□