

# Guide Cylinder/Compact Type

## MGC Series

ø20, ø25, ø32, ø40, ø50

### Integration of guide rods and a base cylinder

#### Air cushion is standard.

Enables the impact to be absorbed at the stroke end when the cylinder is operated at high speeds.

#### Space-saving

Length **20%** shorter  
Height **18%** shorter  
(In comparison with MGG□B32)

#### Lightweight

Weight **32%** reduction  
(In comparison with MGGLB32-100)

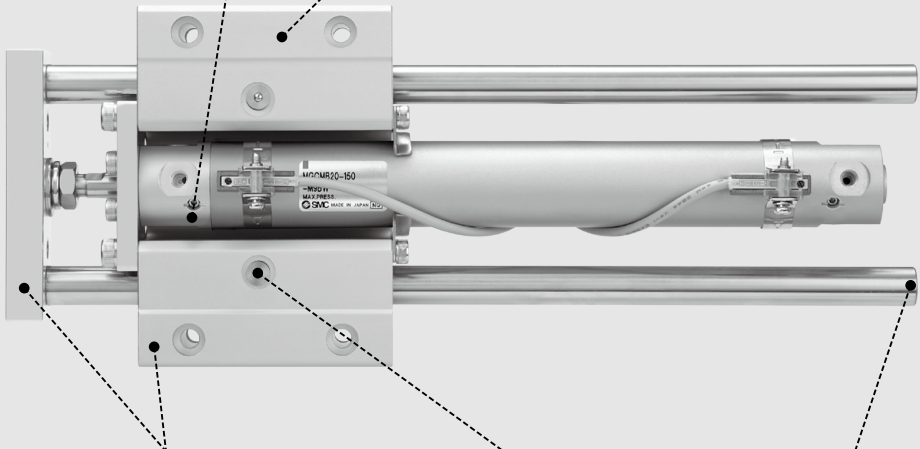

**Compact guide body and front plate**

**Grease nipple offers easy lubrication for bearings.**

**Models without rear plate are available.**

MGJ

JMGP

MGP

MGPW

MGQ

MGG

**MGC**

MGF

MGZ

MGT

### Variations

| Bore size (mm) | Standard stroke (mm) |     |     |     |     |     |     |
|----------------|----------------------|-----|-----|-----|-----|-----|-----|
|                | 75                   | 100 | 125 | 150 | 200 | 250 | 300 |
| 20             | ●                    | ●   | ●   | ●   | ●   | ●   | ●   |
| 25             | ●                    | ●   | ●   | ●   | ●   | ●   | ●   |
| 32             | ●                    | ●   | ●   | ●   | ●   | ●   | ●   |
| 40             | ●                    | ●   | ●   | ●   | ●   | ●   | ●   |
| 50             | ●                    | ●   | ●   | ●   | ●   | ●   | ●   |

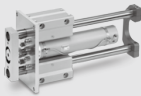

#### Long stroke

| Bore size (mm) | Long stroke (mm) |     |     |     |     |     |     |     |     |     |      |
|----------------|------------------|-----|-----|-----|-----|-----|-----|-----|-----|-----|------|
|                | 250              | 300 | 350 | 400 | 450 | 500 | 600 | 700 | 800 | 900 | 1000 |
| 20             | ●                | ●   | ●   | ●   | ●   | ●   | ●   | ●   | ●   | ●   | ●    |
| 25             | ●                | ●   | ●   | ●   | ●   | ●   | ●   | ●   | ●   | ●   | ●    |
| 32             | ●                | ●   | ●   | ●   | ●   | ●   | ●   | ●   | ●   | ●   | ●    |
| 40             | ●                | ●   | ●   | ●   | ●   | ●   | ●   | ●   | ●   | ●   | ●    |
| 50             | ●                | ●   | ●   | ●   | ●   | ●   | ●   | ●   | ●   | ●   | ●    |



# Guide Cylinder/Compact Type

# MGC Series

ø20, ø25, ø32, ø40, ø50

## How to Order

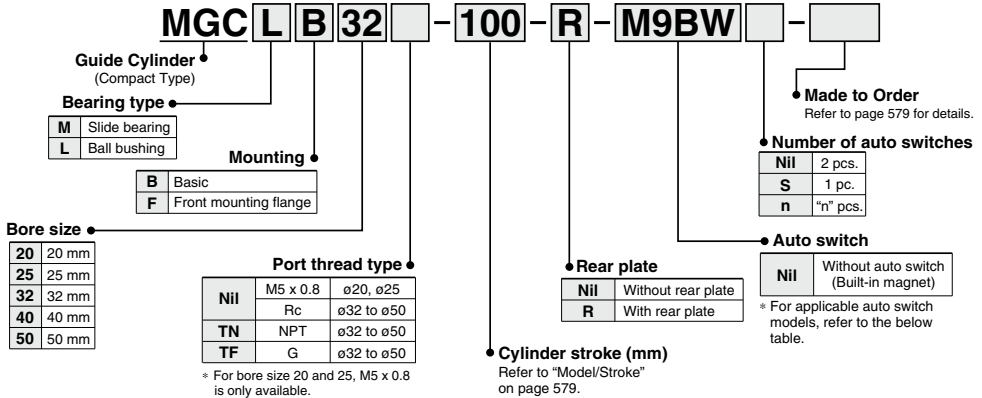

## Applicable Auto Switches/Refer to pages 1119 to 1245 for further information on auto switches.

| Type                                       | Special function                          | Electrical entry | Indicator/light | Wiring (Output)         | Load voltage |              | Auto switch model    |          |      |          | Lead wire length (m) |            |            |            |            | Pre-wired connector | Applicable load |
|--|---|------------------|-----------------|-------------------------|--------------|--------------|----------------------|----------|------|----------|----------------------|------------|------------|------------|------------|---------------------|-----------------|
|  |   |                  |                 |                         | DC           | AC           | Applicable bore size |          |      |          | 0.5 (Nil)            | 1 (M)      | 3 (L)      | 5 (Z)      | None (N)   |                     |                 |
|  |   |                  |                 |                         |              |              | ø20 to ø50           | ø20, ø25 | ø32  | ø40, ø50 |                      |            |            |            |            |                     |                 |
| Solid state auto switch                    | —   | Grommet          | —               | 3-wire (NPN)            | 5V, 12V      | —            | M9NV                 | M9N      | ●    | ●        | ○                    | —          | ○          | IC circuit | Relay, PLC |                     |                 |
|  |   |                  |                 | 3-wire (PNP)            |              |              | M9PV                 | M9P      | ●    | ●        | ○                    | —          | ○          |            |            |                     |                 |
|  |   | Connector        |                 | 2-wire                  | M9BV         | M9B          | ●                    | ●        | ○    | —        | ○                    | —          |            |            |            |                     |                 |
|  |   |                  |                 | —                       | H7C          | —            | —                    | —        | —    | —        | —                    |            |            |            |            |                     |                 |
|  | Diagnostic indication (2-color indicator) | Grommet          | Yes             | 3-wire (NPN)            | 5V, 12V      | —            | M9NWX                | M9NW     | ●    | ●        | ○                    | —          | ○          | IC circuit |            |                     |                 |
|  |   |                  |                 | 3-wire (PNP)            |              |              | M9PWX                | M9PW     | ●    | ●        | ○                    | —          | ○          |            |            |                     |                 |
|  | Water resistant (2-color indicator)       | Grommet          | —               | 2-wire                  | 12V          | —            | M9BWX                | M9BW     | ●    | ●        | ○                    | —          | ○          | —          |            |                     |                 |
|  |   |                  |                 | 3-wire (NPN)            |              |              | M9NAV*1              | M9NA*1   | ○    | ○        | ●                    | ○          | —          |            |            | IC circuit          |                 |
|  |   |                  |                 | 3-wire (PNP)            | M9PAV*1      | M9PA*1       | ○                    | ○        | ●    | ○        | —                    | IC circuit |            |            |            |                     |                 |
|  |   |                  |                 | 2-wire                  | M9BAV*1      | M9BA*1       | ○                    | ○        | ○    | ○        | —                    |            | IC circuit |            |            |                     |                 |
| With diagnostic output (2-color indicator) | 4-wire (NPN)                              | 5V, 12V          | —               | H7NF                    | ●            | —            | ●                    | ○        | —    | ○        | IC circuit           |            |            |            |            |                     |                 |
| Reed auto switch                           | —   | Grommet          | Yes             | 3-wire (NPN equivalent) | 24V          | 12V          | 5V                   | A96V     | A96  | ●        | —                    | ●          | —          | —          | IC circuit | Relay, PLC          |                 |
|  |   |                  |                 | 100V                    |              |              | A93V*2               | A93      | ●    | ●        | ●                    | ●          | —          | —          |            |                     |                 |
|  |   |                  |                 | 100V or less            |              |              | A90V                 | A90      | ●    | —        | ●                    | —          | —          | —          |            |                     | IC circuit      |
|  |   |                  |                 | 100V, 200V              |              |              | —                    | (B54)    | B54  | ●        | —                    | ●          | —          | —          |            |                     |                 |
|  |   | Connector        | None            | Yes                     | 2-wire       | 200V or less | —                    | (B64)    | B64  | ●        | —                    | ●          | —          | —          | —          |                     |                 |
|  |   |                  |                 |                         |              | —            | —                    | C73C     | ●    | —        | ●                    | ●          | —          |            |            |                     |                 |
|  |   |                  |                 |                         |              | 24V or less  | —                    | C80C     | ●    | —        | ●                    | ●          | —          | IC circuit |            |                     |                 |
|  |   |                  |                 |                         |              | —            | —                    | (B59W)   | B59W | ●        | —                    | ●          | —          |            |            |                     | —               |

\*1 Water resistant type auto switches can be mounted on the above models, but in such case SMC cannot guarantee water resistance.

Consult with SMC regarding water resistant types with the above model numbers.

\*2 1 m type lead wire is only applicable to D-A93.

\* Lead wire length symbols: 0.5 m ..... Nil (Example) M9NV  
 1 m ..... M (Example) M9NWX  
 3 m ..... L (Example) M9NWL  
 5 m ..... Z (Example) M9NWX  
 None ..... N (Example) H7CN

\* Solid state auto switches marked with "○" are produced upon receipt of order.

\* Since there are other applicable auto switches than listed, refer to page 591 for details.

\* For details about auto switches with pre-wired connector, refer to pages 1192 and 1193.

\* The D-A9□(V)/M9□(V)/M9□W(V)/M9□A(V) are shipped together, (but not assembled).

(Only switch mounting brackets are assembled at the time of shipment.)

### Caution

When using auto switches shown inside ( ), stroke end detection may not be possible depending on the One-touch fitting or speed controller model. Please contact SMC in this case.

## Model/Specifications

### Model/Stroke

| Model (Bearing type)           | Bore size (mm) | Standard stroke (mm)               | Long stroke (mm)                               |
|--------------------------------|----------------|------------------------------------|--|
| <b>MGCM</b><br>(Slide bearing) | <b>20</b>      | 75, 100, 125, 150, 200             | 250, 300, 350, 400                             |
|                                | <b>25</b>      |                                    | 350, 400, 450, 500                             |
|                                | <b>32</b>      |                                    | 350, 400, 450, 500, 600                        |
| <b>MGCL</b><br>(Ball bushing)  | <b>40</b>      | 75, 100, 125, 150<br>200, 250, 300 | 350, 400, 450, 500, 600<br>700, 800            |
|                                | <b>50</b>      |                                    | 350, 400, 450, 500, 600<br>700, 800, 900, 1000 |

\* Intermediate strokes and short strokes other than the above are produced upon receipt of order.

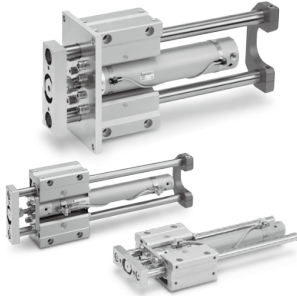

**Symbol**  
Air cushion

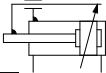

**Made to Order**  
Made to Order: Individual Specifications  
(For details, refer to page 593.)

| Symbol | Specifications               |
|--------|------------------------------|
| -X440  | With piping ports for grease |

### Made to Order

[Click here for details](#)

| Symbol | Specifications  |
|--------|---|
| -XB6   | Heat resistant cylinder (-10 to 150°C)                    |
| -XB13  | Low speed cylinder (5 to 50 mm/s)                         |
| -XC4   | With heavy duty scraper                                   |
| -XC6□  | Made of stainless steel                                   |
| -XC8   | Adjustable stroke cylinder/Adjustable extension type      |
| -XC9   | Adjustable stroke cylinder/Adjustable retraction type     |
| -XC11  | Dual stroke cylinder/Single rod                           |
| -XC13  | Auto switch rail mounting type                            |
| -XC22  | Fluororubber seal   |
| -XC35  | With coil scraper   |
| -XC37  | Larger throttle diameter of connecting port               |
| -XC56  | With knock pin holes                                      |
| -XC73  | Built-in cylinder with lock (CDNG)                        |
| -XC74  | With front plate for MGGM                                 |
| -XC78  | Auto switch mounting special dimensions at stroke end     |
| -XC79  | Tapped hole, drilled hole, pin hole machined additionally |

### Specifications

| Model                                       | MGCM20  | MGCM25 | MGCM32 | MGCM40 | MGCM50 |        |
|---|---|--------|--------|--------|--------|--------|
| Base cylinder                               | CDG1ZA   Bore size   Port thread type   Stroke   Z-   Auto switch |        |        |        |        |        |
| Bore size (mm)                              | 20  | 25     | 32     | 40     | 50     |        |
| Action                                      | Double acting   |        |        |        |        |        |
| Fluid                                       | Air   |        |        |        |        |        |
| Proof pressure                              | 1.5 MPa   |        |        |        |        |        |
| Maximum operating pressure                  | 1.0 MPa   |        |        |        |        |        |
| Minimum operating pressure                  | 0.15 MPa (Horizontal, No load)                                    |        |        |        |        |        |
| Ambient and fluid temperature               | -10 to 60°C   |        |        |        |        |        |
| Piston speed                                | 50 to 750 mm/s  |        |        |        |        |        |
| Cushion                                     | Air cushion   |        |        |        |        |        |
| Base cylinder lubrication                   | Non-lube  |        |        |        |        |        |
| Stroke length tolerance                     | +1.9<br>+0.2 mm   |        |        |        |        |        |
| Non-rotating accuracy <sup>*1</sup>         | Slide bearing   | ±0.07° | ±0.06° | ±0.06° | ±0.05° | ±0.04° |
|   | Ball bushing  | ±0.06° | ±0.05° | ±0.04° | ±0.04° | ±0.04° |
| Piping port size (Rc, NPT, G) <sup>*2</sup> | M5 x 0.8  |        |        | 1/8    | 1/4    |        |

\*1 When the cylinder is retracted (initial value), the non-rotating accuracy without loads or deflection of the guide rods will be below the values shown in the above table as a guideline.

\*2 For bore sizes 20 and 25, M5 x 0.8 is only available.

### Theoretical Output

| Bore size (mm) | Rod size (mm) | Operating direction | Piston area (mm <sup>2</sup> ) | Operating pressure (MPa) |      |     |     |      |      |      |      |      |
|----------------|---------------|---------------------|--------------------------------|--------------------------|------|-----|-----|------|------|------|------|------|
|                |               |                     |                                | 0.2                      | 0.3  | 0.4 | 0.5 | 0.6  | 0.7  | 0.8  | 0.9  | 1.0  |
|                |               |                     |                                | OUT                      | IN   | OUT | IN  | OUT  | IN   | OUT  | IN   | OUT  |
| 20             | 8             | OUT                 | 314                            | 62.8                     | 94.2 | 126 | 157 | 188  | 220  | 251  | 283  | 314  |
|                |               | IN                  | 264                            | 52.8                     | 79.2 | 106 | 132 | 158  | 185  | 211  | 238  | 264  |
| 25             | 10            | OUT                 | 491                            | 98.2                     | 147  | 196 | 246 | 295  | 344  | 393  | 442  | 491  |
|                |               | IN                  | 412                            | 82.4                     | 124  | 165 | 206 | 247  | 288  | 330  | 371  | 412  |
| 32             | 12            | OUT                 | 804                            | 161                      | 241  | 322 | 402 | 482  | 563  | 643  | 724  | 804  |
|                |               | IN                  | 691                            | 138                      | 207  | 276 | 346 | 415  | 484  | 553  | 622  | 691  |
| 40             | 16            | OUT                 | 1260                           | 252                      | 378  | 504 | 630 | 756  | 882  | 1010 | 1130 | 1260 |
|                |               | IN                  | 1060                           | 212                      | 318  | 424 | 530 | 636  | 742  | 848  | 954  | 1060 |
| 50             | 20            | OUT                 | 1960                           | 392                      | 588  | 784 | 980 | 1180 | 1370 | 1570 | 1760 | 1960 |
|                |               | IN                  | 1650                           | 330                      | 495  | 660 | 825 | 990  | 1160 | 1320 | 1490 | 1650 |

Note) Theoretical output (N) = Pressure (MPa) x Piston area (mm<sup>2</sup>)

MGJ

JMP

MGPM

MGPMW

MGQ

MGG

MGCM

MGF

MGZ

MGTM

D-□

-X□

## Weight

| Bore size (mm)                             |  | 20    | 25    | 32    | 40    | 50    |
|--|--|-------|-------|-------|-------|-------|
| Basic weight                               | LB type (Ball bushing bearing/Basic)                 | 1.04  | 1.55  | 2.07  | 3.32  | 6.45  |
|  | LF type (Ball bushing bearing/Front mounting flange) | 1.7   | 2.35  | 3.02  | 5.02  | 8.58  |
|  | MB type (Slide bearing/Basic)                        | 1.02  | 1.51  | 2.03  | 3.26  | 6.35  |
|  | MF type (Slide bearing/Front mounting flange)        | 1.69  | 2.32  | 2.98  | 4.96  | 8.48  |
| Additional weight with rear plate          |  | 0.2   | 0.25  | 0.34  | 0.58  | 1.04  |
| Additional weight per each 50 mm of stroke |  | 0.14  | 0.17  | 0.25  | 0.4   | 0.61  |
| Additional weight for long stroke          |  | 0.01  | 0.01  | 0.02  | 0.03  | 0.06  |
| Additional weight with bracket             |  | 0.011 | 0.018 | 0.019 | 0.031 | 0.061 |

(kg)

Calculation: (Example)

### MGCLB32-500-R

(Ball bushing bearing/Basic, ø32/500 st., with rear plate, with bracket)

- Basic weight ..... 2.07 (LB type)
- Additional weight with rear plate ..... 0.34
- Additional stroke weight ..... 0.25/50 st
- Stroke ..... 500 st
- Additional weight for long stroke ..... 0.02
- Additional weight with bracket ..... 0.019

$$2.07 + 0.34 + 0.25 \times 500/50 + 0.02 + 0.019 = 4.95 \text{ kg}$$

## Moving Parts Weight

| Bore size (mm)                             |  | 20   | 25   | 32   | 40   | 50   |
|--|--|------|------|------|------|------|
| Moving parts basic weight                  |  | 0.34 | 0.53 | 0.69 | 1.2  | 2.45 |
| Additional weight with rear plate          |  | 0.2  | 0.25 | 0.34 | 0.58 | 1.04 |
| Additional weight per each 50 mm of stroke |  | 0.11 | 0.14 | 0.2  | 0.33 | 0.51 |

(kg)

Calculation: (Example)

### MGCLB32-500-R

- Moving parts basic weight ..... 0.69
- Additional weight with rear plate ..... 0.34
- Additional stroke weight ..... 0.2/50 st.
- Stroke ..... 500 st.

$$0.69 + 0.34 + 0.2 \times 500/50 = 3.03 \text{ kg}$$

## Allowable Kinetic Energy by Air Cushion Mechanism

| Bore size (mm) | Effective cushion length (mm) | R: Rod end, H: Head end      |  |
|----------------|-------------------------------|------------------------------|--|
|                |                               | Allowable kinetic energy (J) |  |
| 20             | R: 7, H: 7.5                  | R: 0.35, H: 0.42             |  |
| 25             | R: 7, H: 7.5                  | R: 0.56, H: 0.65             |  |
| 32             | 7.5                           | 0.91                         |  |
| 40             | 8.7                           | 1.8                          |  |
| 50             | 11.8                          | 3.4                          |  |

High kinetic energy generated by large loads and high speed operations can be absorbed by compressing air at the stroke end thus preventing shock and vibration being transmitted to the machine. The air cushion has not been designed to control the piston speed in the end regions of the stroke. The load kinetic energy can be obtained by the following equation:



$$E_k = \frac{M + m}{2} U^2 \quad U = 1.4 U_a$$

- Ek: Kinetic energy (J)
- M: Weight of the driven object (kg)
- m: Weight of moving parts of cylinder (kg)
- U: Maximum speed (m/s)
- Ua: Average speed (m/s)

Note) Set Ua so that rush speed into cushion U should not exceed 0.75 m/s.

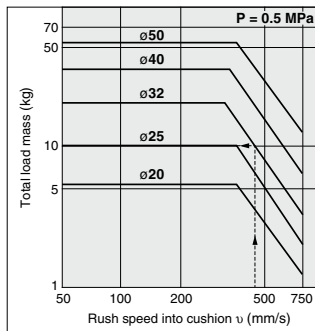

Also, selection can be made by using the graph above.

Example)

Find the maximum load mass when using a cylinder with ø32, stroke 500 mm, with rear plate as a lifter at an average speed of Ua 300 mm/s.

Rush speed into cushion U is as follows:

$$U = 1.4 \times 300 = 420 \text{ mm/s.}$$

Extend upward from 420 mm/s on the abscissa in the graph until crossing at the line of bore size 32. Extend leftward from the intersection to find the total load weight 10 kg.

Subtract the moving parts weight of 3.08 kg from this. (For moving parts, refer to "Moving Parts Weight".) 6.92 kg will be obtained, which is equal to the maximum load weight.

## ⚠ Caution

In a horizontal application, pay attention to that the load weight should not exceed the allowable end load given on pages 582 to 585.

## Air-hydro

Low pressure hydraulic cylinder of 1.0 MPa or less  
 Through the concurrent use of the CC series air-hydro unit, it becomes possible to operate at a constant or low speed or to effect an intermediate stop, just like a hydraulic unit, while using pneumatic equipment such as a valve.

**MGC**H  Bearing type  Mounting  Bore size  Stroke  With/Without rear plate  
 ↓  
 Air-hydro

### Specifications

|                                      |                                |
|--------------------------------------|--------------------------------|
| Bore size (mm)                       | <b>20, 25, 32, 40, 50</b>      |
| <b>Action</b>                        | Double acting                  |
| <b>Fluid</b>                         | Turbine oil                    |
| <b>Proof pressure</b>                | 1.5 MPa                        |
| <b>Maximum operating pressure</b>    | 1.0 MPa                        |
| <b>Minimum operating pressure</b>    | 0.18 MPa (Horizontal, No load) |
| <b>Piston speed</b>                  | 15 to 300 mm/s                 |
| <b>Cushion</b>                       | None                           |
| <b>Ambient and fluid temperature</b> | +5 to 60°C                     |
| <b>Mounting</b>                      | Basic<br>Front mounting flange |

\* For specifications other than the above, refer to page 579.

\* Auto switch can be mounted.

### Dimensions (Dimensions other than the below are the same as standard type.)

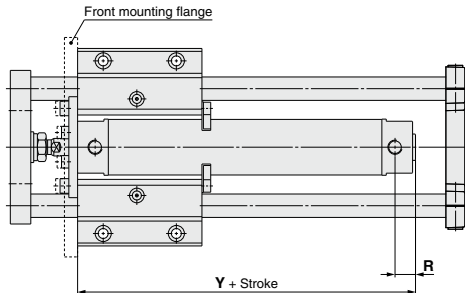

| (mm)           |    |     |
|----------------|----|-----|
| Bore size (mm) | R  | Y   |
| <b>20</b>      | 14 | 79  |
| <b>25</b>      | 14 | 79  |
| <b>32</b>      | 14 | 81  |
| <b>40</b>      | 15 | 89  |
| <b>50</b>      | 16 | 104 |

### Series Applicable to Operating Environments that Do Not Accept Copper

- Copper and Fluorine-free ... 20 series
- \* For details, refer to the SMC website.

MGJ  
 JMGP  
 MGP  
 MGPW  
 MGQ  
 MGG  
**MGC**  
 MGF  
 MGZ  
 MGT

D-□  
 -X□

# MGC Series

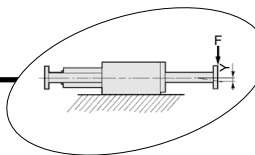

## Slide Bearing Allowable End Load and Deflection

MGCM -Stroke-R

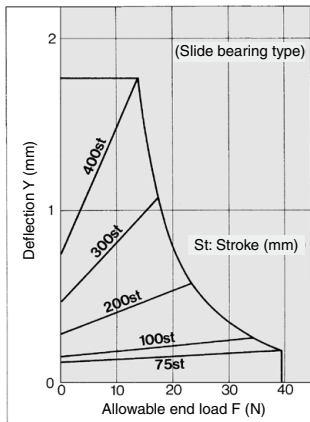

MGCM -Stroke-R

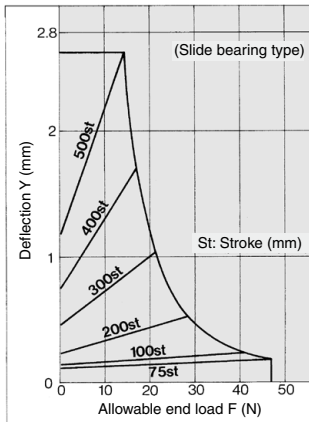

MGCM -Stroke-R

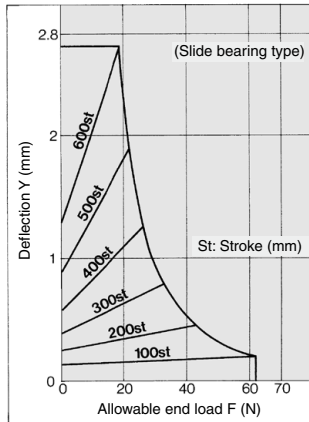

MGCM -Stroke-R

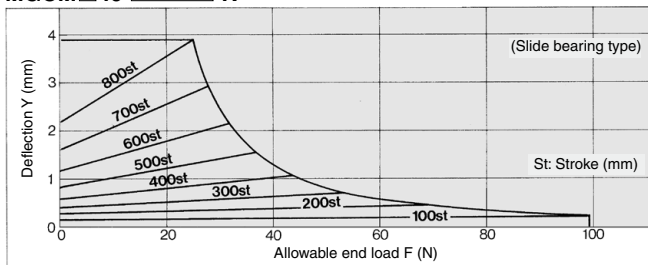

MGCM -Stroke-R

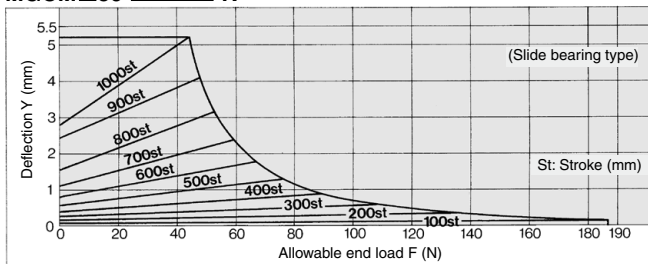

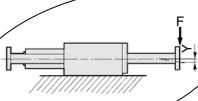

**Ball Bushing Bearing  
Allowable End Load and Deflection**

**MGCL**  **20-Stroke** -R

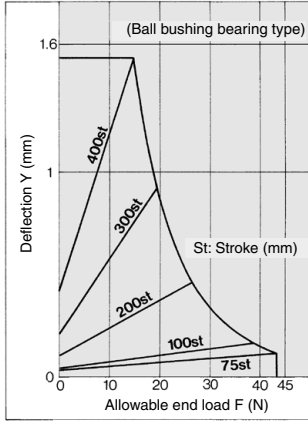

**MGCL**  **25-Stroke** -R

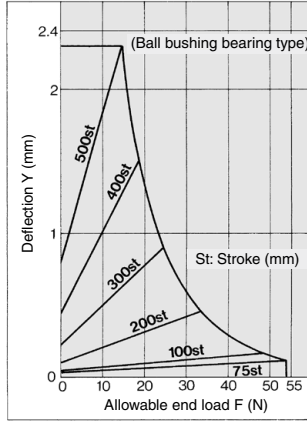

**MGCL**  **32-Stroke** -R

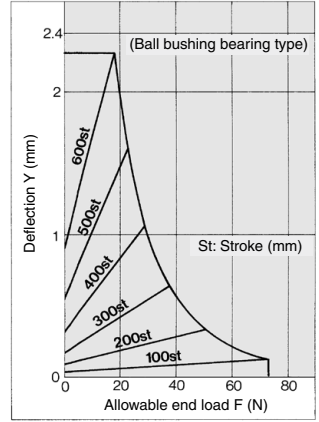

**MGCL**  **40-Stroke** -R

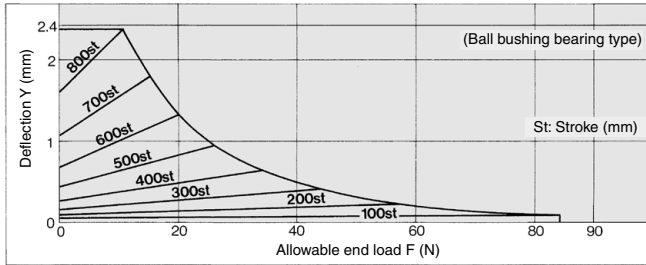

**MGCL**  **50-Stroke** -R

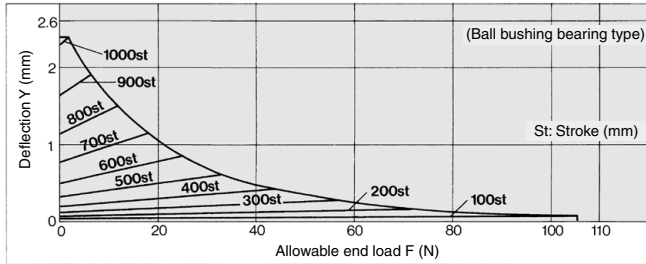

**MGJ**

**JMGP**

**MGP**

**MGPW**

**MGQ**

**MGG**

**MGC**

**MGF**

**MGZ**

**MGT**

**D-□**

**-X□**

# MGC Series

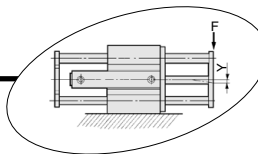

## Slide Bearing Allowable End Load and Deflection

**MGCM □20-Stroke-R**

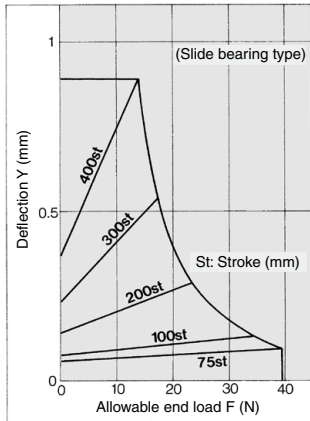

**MGCM □25-Stroke-R**

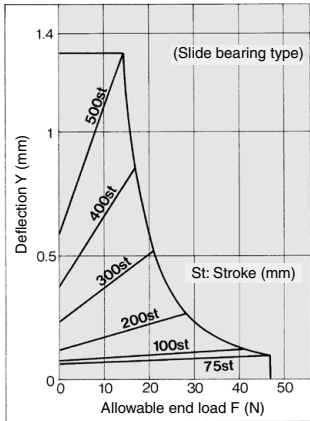

**MGCM □32-Stroke-R**

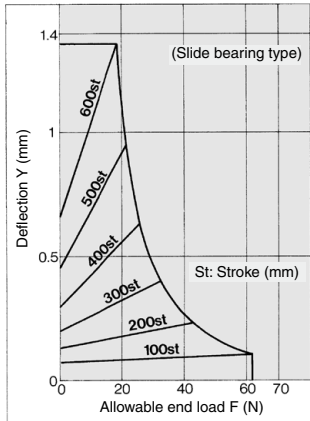

**MGCM □40-Stroke-R**

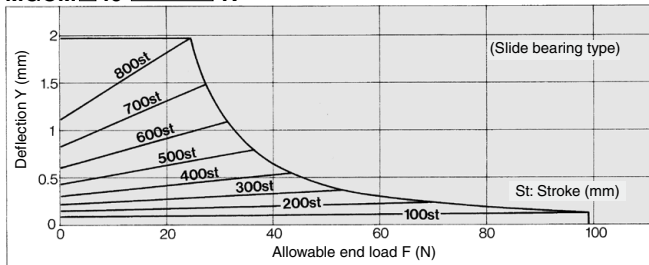

**MGCM □50-Stroke-R**

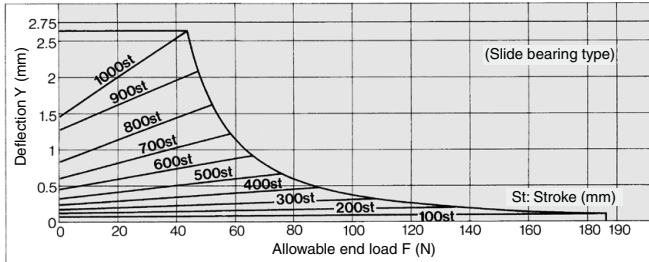



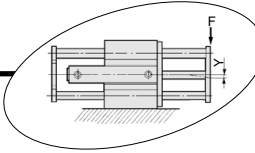

**Ball Bushing Bearing  
Allowable End Load and Deflection**

**MGCL**  **20** - **Stroke**  - **R**

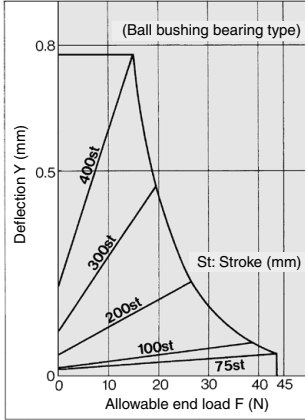

**MGCL**  **25** - **Stroke**  - **R**

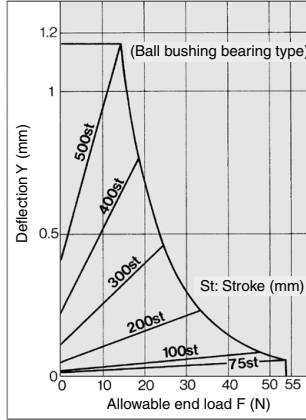

**MGCL**  **32** - **Stroke**  - **R**

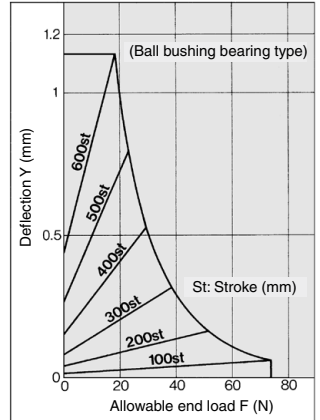

**MGCL**  **40** - **Stroke**  - **R**

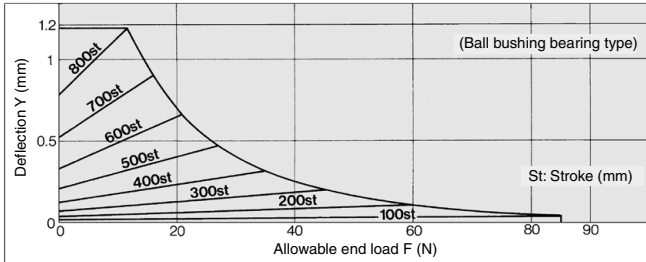

**MGCL**  **50** - **Stroke**  - **R**

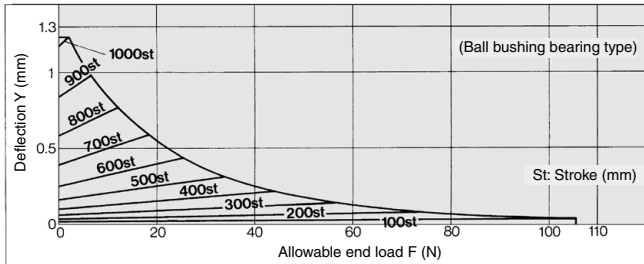

**MGJ**

**JMGP**

**MGP**

**MGPW**

**MGQ**

**MGG**

**MGC**

**MGF**

**MGZ**

**MGT**

**D**-

**-X**

## Allowable Eccentric Load

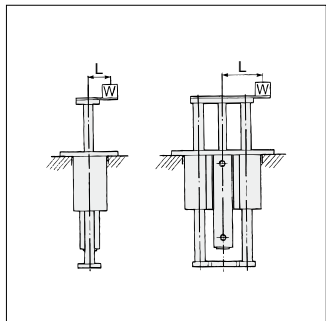

Slide Bearing/  
MGCM□□-Stroke-R

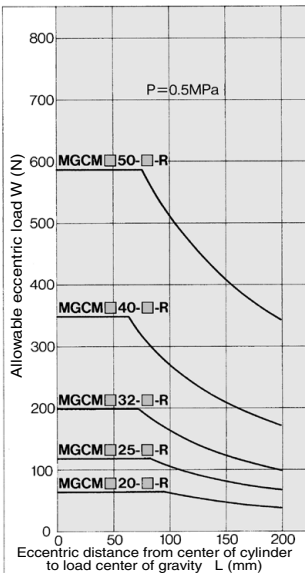

(Set the maximum allowable load so that it does not exceed the following percentages of the theoretical output: 40% for ø20, 50% for ø25 and ø32, 55% for ø40 and 60% or less for ø50, respectively.)

Ball Bushing Bearing/  
MGCL□□-Stroke-R

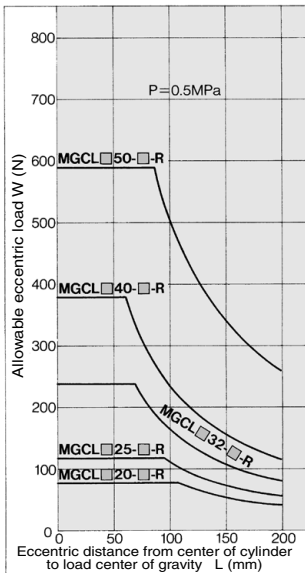

(Set the maximum allowable load so that it does not exceed the following percentages of the theoretical output: 40% for ø20, 50% for ø25 and ø32, 55% for ø40 and 60% or less for ø50, respectively.)

**Construction: With Rear Plate**

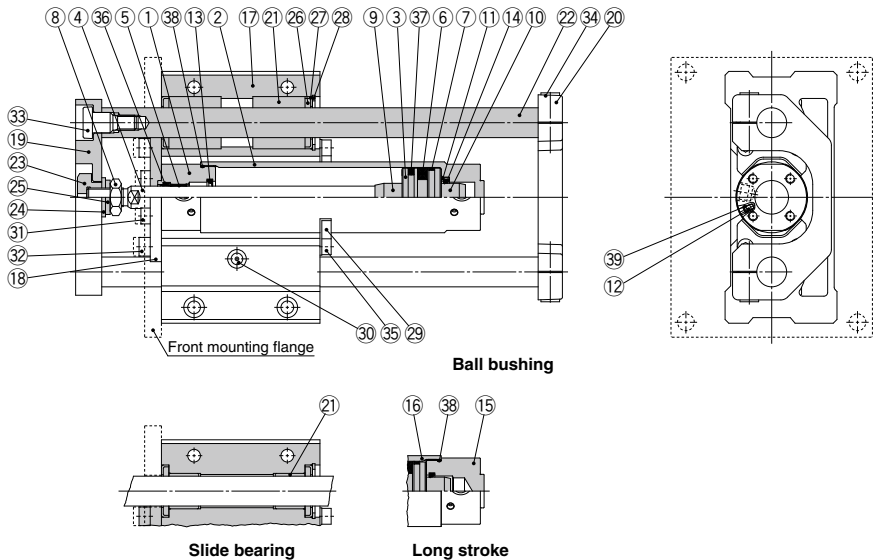

**Component Parts**

| No. | Description                    | Material          | Note  |
|-----|--------------------------------|-------------------|---|
| 1   | Rod cover                      | Aluminum alloy    | Hard anodized   |
| 2   | Tube cover                     | Aluminum alloy    | Hard anodized   |
| 3   | Piston                         | Aluminum alloy    |   |
| 4   | Piston rod                     | Stainless steel   | For $\phi 20$ , $\phi 25$                             |
|     |                                | Carbon steel      | Hard chrome plating For $\phi 32$ to $\phi 50$        |
| 5   | Bushing                        | Bearing alloy     |   |
| 6   | Magnet                         | —                 |   |
| 7   | Wear ring                      | Resin             |   |
| 8   | Rod end nut                    | Carbon steel      | Zinc chromated  |
| 9   | Cushion ring A                 | Aluminum alloy    |   |
| 10  | Cushion ring B                 | Aluminum alloy    |   |
| 11  | Seal retainer                  | Carbon steel      | Zinc chromated  |
| 12  | Cushion valve                  | Carbon steel      | Electroless nickel plating For $\phi 20$ to $\phi 40$ |
|     |                                | Carbon steel      | Zinc chromated For $\phi 50$                          |
| 13  | Cushion seal A                 | Urethane          | $\phi 32$ or larger is common.                        |
| 14  | Cushion seal B                 | Urethane          |   |
| 15  | Head cover                     | Aluminum alloy    | Hard anodized For long stroke                         |
| 16  | Cylinder tube                  | Aluminum alloy    | Hard anodized   |
| 17  | Guide body                     | Aluminum alloy    | Anodized  |
| 18  | Small flange                   | Carbon steel      | Nickel plating For basic                              |
| 18  | Large flange                   | Carbon steel      | Nickel plating For front mounting flange              |
| 19  | Front plate                    | Carbon steel      | Nickel plating  |
| 20  | Rear plate                     | Cast iron         | Painted   |
| 21  | Slide bearing                  | Bearing alloy     | For slide bearing                                     |
| 21  | Ball bushing                   | —                 | For ball bushing                                      |
| 22  | Guide rod                      | Carbon steel      | Hard chrome plating For slide bearing                 |
|     |                                | Carbon steel      | Quenched, hard chrome plating For ball bushing        |
| 23  | End bracket                    | Carbon steel      | Nickel plating  |
| 24  | Flat washer                    | Carbon steel      | Zinc chromated  |
| 25  | Spring washer                  | Carbon steel      | Zinc chromated  |
| 26  | Felt                           | Felt              |   |
| 27  | Holder                         | Stainless steel   |   |
| 28  | Type C retaining ring for hole | Carbon tool steel | Phosphate coated                                      |
| 29  | Bracket                        | Stainless steel   |   |
| 30  | Nipple                         | —                 | Nickel plating  |
| 31  | Hexagon socket head cap screw  | Carbon steel      | Zinc chromated For cylinder mounting                  |
| 32  | Hexagon socket head cap screw  | Carbon steel      | Zinc chromated For large/small flange mounting        |

**Component Parts**

| No. | Description                   | Material     | Note                                    |
|-----|-------------------------------|--------------|---|
| 33  | Guide bolt                    | Carbon steel | Nickel plating For front plate mounting |
| 34  | Hexagon socket head cap screw | Carbon steel | Zinc chromated For rear plate mounting  |
| 35  | Hexagon socket head cap screw | Carbon steel | Zinc chromated For bracket mounting     |
| 36  | Rod seal                      | NBR          |   |
| 37  | Piston seal                   | NBR          |   |
| 38  | Tube gasket                   | NBR          |   |
| 39  | Valve seal                    | NBR          |   |

**Replacement Parts/Seal Kit**

| Bore size (mm) | Kit no.    | Contents                        |
|----------------|------------|---------------------------------|
| 20             | CG1N20Z-PS | Set of nos. above<br>36, 37, 38 |
| 25             | CG1N25Z-PS |                                 |
| 32             | CG1N32Z-PS |                                 |
| 40             | CG1N40Z-PS |                                 |

Note) Refer to the following precautions for disassembly/replacement. Order with the kit number according to the bore size.  
 \* Seal kit includes a grease pack (10 g). Order with the following part number when only the grease pack is needed.  
 Grease pack part number: GR-S-010 (10 g)

**⚠ Caution**

- Do not replace the bushings.
- To replace a seal, apply grease to the new seal before installing it. If the cylinder is put into operation without applying grease to the seal, it could cause the seal to wear significantly, leading to premature air leakage.
- Basic cylinders with a bore size of  $\phi 50$  cannot be disassembled. When disassembling cylinders with bore sizes of  $\phi 20$  through  $\phi 40$ , grip the double flat part of either the tube cover or the rod cover with a vise and loosen the other side with a wrench or a monkey wrench etc., and then remove the cover. When retightening, tighten approximately 2 degrees more than the original position. (Cylinders with bore size  $\phi 50$  are tightened with a large tightening torque and cannot be disassembled. If disassembly is required, please contact SMC.)

MGJ  
JMP  
MGP  
MGPW  
MGQ  
MGG  
MGC  
MGF  
MGZ  
MGT

D-□  
-X□

# MGC Series

## Dimensions

Basic: With rear plate

MGC□B□□□-□-**R**

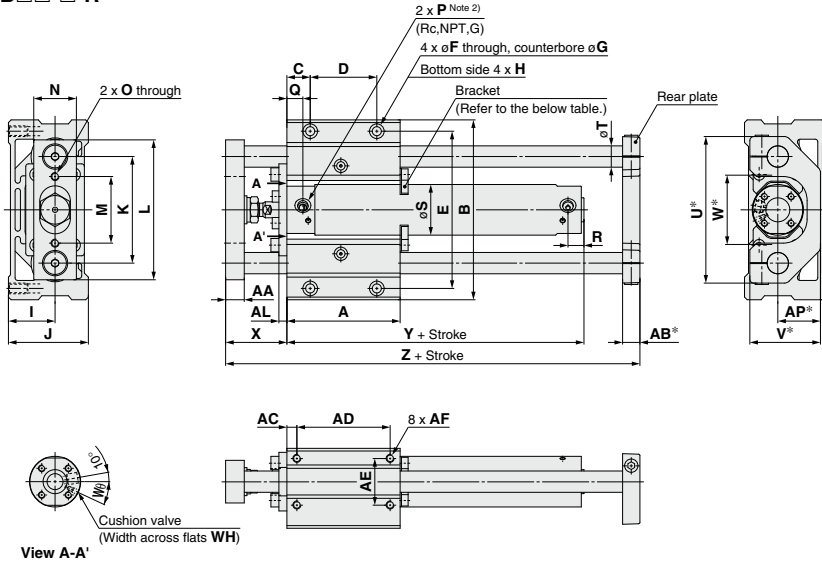

View A-A'

| Bore size (mm) | Stroke range (mm)                | A   | AA | AB* | AC  | AD  | AE | AF                 | AL | AP* | B   | C    | D  | E   | F    | G           | H                   |
|----------------|----------------------------------|-----|----|-----|-----|-----|----|--------------------|----|-----|-----|------|----|-----|------|-------------|---------------------|
|                |                                  |     |    |     |     |     |    |                    |    |     |     |      |    |     |      |             |                     |
| 20             | 75, 100, 125, 150, 200           | 75  | 11 | 13  | 6.5 | 62  | 25 | M5 x 0.8 depth 10  | 6  | 22  | 106 | 15   | 45 | 90  | 5.4  | 9.5 depth 6 | M6 x 1 depth 10     |
| 25             | 75, 100, 125, 150, 200, 250, 300 | 80  | 14 | 13  | 7.5 | 65  | 30 | M6 x 1 depth 12    | 6  | 27  | 120 | 17.5 | 45 | 103 | 6.8  | 11 depth 8  | M8 x 1.25 depth 14  |
| 32             |                                  | 85  | 14 | 13  | 7.5 | 70  | 35 | M6 x 1 depth 12    | 6  | 32  | 135 | 17.5 | 50 | 118 | 6.8  | 11 depth 8  | M8 x 1.25 depth 14  |
| 40             |                                  | 95  | 17 | 16  | 10  | 75  | 40 | M8 x 1.25 depth 16 | 9  | 37  | 160 | 22.5 | 50 | 140 | 8.6  | 14 depth 10 | M10 x 1.5 depth 18  |
| 50             |                                  | 130 | 23 | 19  | 10  | 110 | 45 | M10 x 1.5 depth 20 | 9  | 42  | 194 | 25   | 80 | 170 | 10.5 | 17 depth 12 | M12 x 1.75 depth 21 |

| Bore size (mm) | I  | J    | K   | L   | M  | N  | O         | P Note 2) | Rc, NPT port | G port | R  | S  | T  | U*  | V* | W* | WH  | W $\phi$ | X  | Y  | Z   |
|----------------|----|------|-----|-----|----|----|-----------|-----------|--------------|--------|----|----|----|-----|----|----|-----|----------|----|----|-----|
|                |    |      |     |     |    |    |           |           | Q            | Q      |    |    |    |     |    |    |     |          |    |    |     |
| 20             | 25 | 44   | 60  | 80  | 38 | 25 | M6 x 1    | M5 x 0.8  | 12           | 12     | 12 | 26 | 12 | 86  | 40 | 36 | 1.5 | 25°      | 39 | 71 | 140 |
| 25             | 30 | 52   | 70  | 95  | 46 | 32 | M6 x 1    | M5 x 0.8  | 12.5         | 12.5   | 12 | 31 | 13 | 98  | 47 | 44 | 1.5 | 25°      | 46 | 71 | 153 |
| 32             | 35 | 60   | 80  | 105 | 50 | 32 | M6 x 1    | 1/8       | 12           | 10.5   | 12 | 38 | 16 | 112 | 53 | 50 | 1.5 | 25°      | 46 | 73 | 161 |
| 40             | 40 | 70   | 95  | 125 | 60 | 38 | M8 x 1.25 | 1/8       | 13           | 13     | 12 | 47 | 20 | 132 | 63 | 60 | 1.5 | 20°      | 56 | 80 | 188 |
| 50             | 45 | 82.5 | 115 | 150 | 75 | 50 | M8 x 1.25 | 1/4       | 14           | 14     | 14 | 58 | 25 | 162 | 73 | 70 | 3   | 20°      | 67 | 92 | 241 |

Without Rear Plate

Long Stroke

Bracket Mounting Stroke

| Bore size (mm) | Z   |
|----------------|-----|
| 20             | 119 |
| 25             | 131 |
| 32             | 136 |
| 40             | 156 |
| 50             | 202 |

| Bore size (mm) | Stroke range (mm) | Rc, NPT port | G port | Y   |
|----------------|-------------------|--------------|--------|-----|
|                |                   | R            | R      |     |
| 20             | 250 to 400        | 14           | 14     | 79  |
| 25             | 350 to 500        | 14.5         | 14.5   | 79  |
| 32             | 350 to 600        | 14           | 12.5   | 81  |
| 40             | 350 to 800        | 15           | 12     | 89  |
| 50             | 350 to 1000       | 16           | 16     | 104 |

| Bore size (mm) | Bracket mounting stroke |
|----------------|-------------------------|
| 20             | 100 st or more          |
| 25             | 125 st or more          |
| 32             | 150 st or more          |
| 40             | 200 st or more          |
| 50             | 250 st or more          |

Note 1) Dimensions marked with "\*" are not required for without rear plate.

Note 2) For bore size 20 and 25, M5 x 0.8 is only available. Rc, NPT and G ports are available for bore size 32 or greater.

**Dimensions**

**Front mounting flange: With rear plate**

MGC□F□□□-□-R

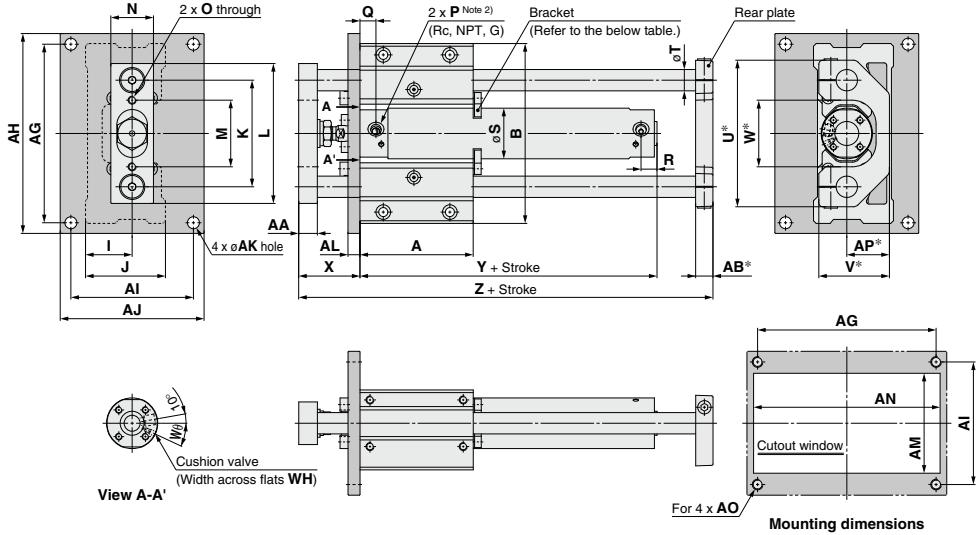

- MGJ
- JMGP
- MGP
- MGPW
- MGQ
- MGG
- MGC**
- MGF
- MGZ
- MGT

| Bore size (mm) | Stroke range (mm)                  | A   | AA | AB* | AG  | AH  | AI  | AJ  | AK  | AL | AM | AN  | AO  | AP* | B   | I  | J    | K   | L   | M  | N  |
|----------------|------------------------------------|-----|----|-----|-----|-----|-----|-----|-----|----|----|-----|-----|-----|-----|----|------|-----|-----|----|----|
| 20             | 75, 100, 125, 150, 200             | 75  | 11 | 13  | 105 | 120 | 75  | 90  | 6.6 | 9  | 55 | 110 | M6  | 22  | 106 | 25 | 44   | 60  | 80  | 38 | 25 |
| 25             | 75, 100, 125, 150<br>200, 250, 300 | 80  | 14 | 13  | 120 | 136 | 84  | 100 | 9   | 9  | 65 | 125 | M8  | 27  | 120 | 30 | 52   | 70  | 95  | 46 | 32 |
| 32             |                                    | 85  | 14 | 13  | 134 | 150 | 92  | 108 | 9   | 9  | 75 | 140 | M8  | 32  | 135 | 35 | 60   | 80  | 105 | 50 | 32 |
| 40             |                                    | 95  | 17 | 16  | 160 | 176 | 110 | 125 | 9   | 12 | 85 | 165 | M8  | 37  | 160 | 40 | 70   | 95  | 125 | 60 | 38 |
| 50             |                                    | 130 | 23 | 19  | 190 | 210 | 115 | 135 | 11  | 12 | 95 | 200 | M10 | 42  | 194 | 45 | 82.5 | 115 | 150 | 75 | 50 |

| Bore size (mm) | O         | P <sup>Note 2)</sup> | Rc, NPT port | G port | R  | S  | T  | U*  | V* | W* | WH  | W $\theta$ | X  | Y  | Z   |
|----------------|-----------|----------------------|--------------|--------|----|----|----|-----|----|----|-----|------------|----|----|-----|
| 20             | M6 x 1    | M5 x 0.8             | Q            | Q      | 12 | 26 | 12 | 86  | 40 | 36 | 1.5 | 25°        | 39 | 71 | 140 |
| 25             | M6 x 1    | M5 x 0.8             | 12.5         | 12.5   | 12 | 31 | 13 | 98  | 47 | 44 | 1.5 | 25°        | 46 | 71 | 153 |
| 32             | M6 x 1    | 1/8                  | 12           | 10.5   | 12 | 38 | 16 | 112 | 53 | 50 | 1.5 | 25°        | 46 | 73 | 161 |
| 40             | M8 x 1.25 | 1/8                  | 13           | 13     | 12 | 47 | 20 | 132 | 63 | 60 | 1.5 | 20°        | 56 | 80 | 188 |
| 50             | M8 x 1.25 | 1/4                  | 14           | 14     | 14 | 58 | 25 | 162 | 73 | 70 | 3   | 20°        | 67 | 92 | 241 |

**Without Rear Plate**

**Long Stroke**

**Bracket Mounting Stroke**

| Bore size (mm) | Z   |
|----------------|-----|
| 20             | 119 |
| 25             | 131 |
| 32             | 136 |
| 40             | 156 |
| 50             | 202 |

| Bore size (mm) | Stroke range (mm) | Rc, NPT port | G port | Y   |
|----------------|-------------------|--------------|--------|-----|
| 20             | 250 to 400        | 14           | 14     | 79  |
| 25             | 350 to 500        | 14.5         | 14.5   | 79  |
| 32             | 350 to 600        | 14           | 12.5   | 81  |
| 40             | 350 to 800        | 15           | 12     | 89  |
| 50             | 350 to 1000       | 16           | 16     | 104 |

| Bore size (mm) | Bracket mounting stroke |
|----------------|-------------------------|
| 20             | 100 st or more          |
| 25             | 125 st or more          |
| 32             | 150 st or more          |
| 40             | 200 st or more          |
| 50             | 250 st or more          |

Note 1) Dimensions marked with "\*" are not required for without rear plate.

Note 2) For bore size 20 and 25, M5 x 0.8 is only available. Rc, NPT and G ports are available for bore size 32 or greater.

- D-□
- X□

# Auto Switch Mounting

## Auto Switch Proper Mounting Position (Detection at Stroke End) and Its Mounting Height

D-M9□, M9□W  
D-M9□A

D-A9□

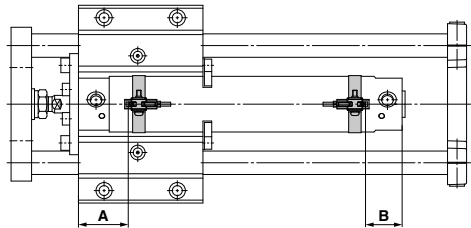
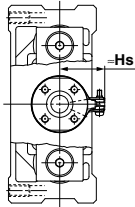

D-M9□V, M9□WV  
D-M9□AV

D-A9□V

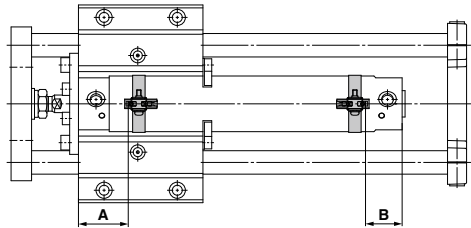
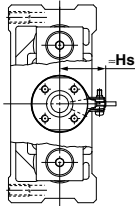

D-H7□, H7□W  
D-H7NF, H7BA  
D-H7C

D-B5, B6, B59W

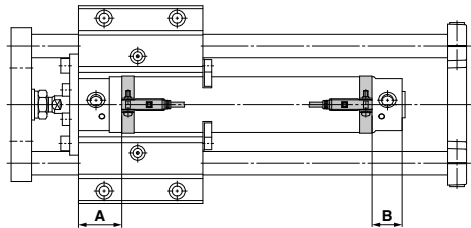
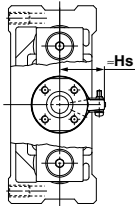

D-G5, K5, G5□W, G5BA  
D-K59W  
D-G59F  
D-G5NT

D-C7, C8  
D-C73C, C80C

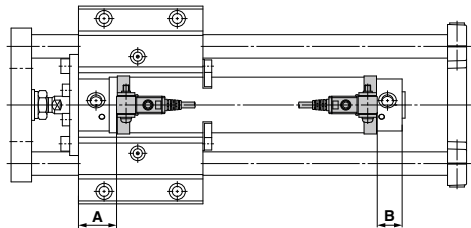
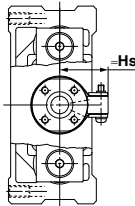

### Auto Switch Proper Mounting Position

| Auto switch model | (mm)                               |                |          |                |                                    |                |                |                |        |                |  |                |  |                |  |  |
|-------------------|------------------------------------|----------------|----------|----------------|------------------------------------|----------------|----------------|----------------|--------|----------------|--|----------------|--|----------------|--|--|
|                   | D-M9□(V)<br>D-M9□W(V)<br>D-M9□A(V) |                | D-A9□(V) |                | D-C7□<br>D-C80<br>D-C73C<br>D-C80C |                | D-B5□<br>D-B64 |                | D-B59W |                | D-H7□W<br>D-H7BA<br>D-H7□<br>D-H7C<br>D-H7NF |                | D-G59F<br>D-G5□W<br>D-K59W<br>D-G5BA<br>D-G5□<br>D-K59<br>D-G5NT |                |  |  |
|                   | A                                  | B              | A        | B              | A                                  | B              | A              | B              | A      | B              | A  | B              | A  | B              |  |  |
| 20                | 33                                 | 24<br>(32)     | 29       | 20<br>(28)     | 29.5                               | 20.5<br>(28.5) | 23.5           | 14.5<br>(22.5) | 26.5   | 17.5<br>(25.5) | 28.5   | 19.5<br>(27.5) | 25   | 16<br>(24)     |  |  |
| 25                | 33.5                               | 24.5<br>(32.5) | 28.5     | 20.5<br>(28.5) | 29                                 | 21<br>(29)     | 23             | 15<br>(23)     | 26     | 18<br>(26)     | 28   | 20<br>(28)     | 24.5   | 16.5<br>(24.5) |  |  |
| 32                | 34                                 | 25<br>(33)     | 30       | 21<br>(29)     | 30.5                               | 21.5<br>(29.5) | 24.5           | 15.5<br>(23.5) | 27.5   | 18.5<br>(26.5) | 29.5   | 20.5<br>(28.5) | 26   | 17<br>(25)     |  |  |
| 40                | 39                                 | 27<br>(36)     | 35       | 23<br>(32)     | 35.5                               | 23.5<br>(32.5) | 29.5           | 17.5<br>(26.5) | 32     | 20.5<br>(29.5) | 34.5   | 22.5<br>(31.5) | 31   | 19<br>(28)     |  |  |
| 50                | 46                                 | 32<br>(44)     | 42       | 28<br>(40)     | 42.5                               | 28.5<br>(40.5) | 36.5           | 22.5<br>(34.5) | 39.5   | 25.5<br>(37.5) | 41.5   | 27.5<br>(39.5) | 38   | 24<br>(36)     |  |  |

### Auto Switch Mounting Height

| Auto switch model | (mm)                                   |      |                  |   |
|-------------------|--|------|------------------|---|
|                   | D-M9□V<br>D-M9□WV<br>D-M9□AV<br>D-A9□V |      | D-C73C<br>D-C80C | D-H7C<br>D-G5NT<br>D-G5□/K59<br>D-K59W<br>D-B57/B64<br>D-B59W<br>D-G5BA<br>D-G59F |
|                   | Hs                                     | Hs   | Hs               | Hs  |
| 20                | 25.5                                   | 24.5 | 27               | 27.5  |
| 25                | 28                                     | 27   | 29.5             | 30  |
| 32                | 31.5                                   | 30.5 | 33               | 33.5  |
| 40                | 36                                     | 35   | 37.5             | 38  |
| 50                | 41.5                                   | 40.5 | 43               | 43.5  |

\* ( ): Values for long stroke, double rod

Note) Adjust the auto switch after confirming the operating conditions in the actual setting.

### Minimum Auto Switch Mounting Stroke

| Auto switch model                                   | n: No. of auto switches (mm) |                           |                                      |
|---|------------------------------|---------------------------|--------------------------------------|
|   | No. of auto switches mounted |                           |                                      |
|   | 1 pc.                        | 2 pcs.<br>Same surface    | "n" pcs.<br>Same surface             |
| <b>D-M9□</b>  | 5                            | 40 <small>Note 1)</small> | 55 + 35 (n-2)<br>(n = 2, 3, 4, 5...) |
| <b>D-M9□W</b>                                       | 10                           | 40 <small>Note 1)</small> | 55 + 35 (n-2)<br>(n = 2, 3, 4, 5...) |
| <b>D-M9□A</b>                                       | 10                           | 40 <small>Note 1)</small> | 60 + 35 (n-2)<br>(n = 2, 3, 4, 5...) |
| <b>D-A9□</b>  | 5                            | 30 <small>Note 1)</small> | 50 + 35 (n-2)<br>(n = 2, 3, 4, 5...) |
| <b>D-M9□V</b>                                       | 5                            | 35                        | 35 + 35 (n-2)<br>(n = 2, 3, 4, 5...) |
| <b>D-A9□V</b>                                       | 5                            | 25                        | 25 + 35 (n-2)<br>(n = 2, 3, 4, 5...) |
| <b>D-M9□VV</b><br><b>D-M9□AV</b>                    | 10                           | 35                        | 35 + 35 (n-2)<br>(n = 2, 3, 4, 5...) |
| <b>D-C7□</b><br><b>D-C80</b>                        | 5                            | 50                        | 50 + 45 (n-2)<br>(n = 2, 3, 4, 5...) |
| <b>D-H7□</b><br><b>D-H7□W</b><br><b>D-H7BA/H7NF</b> | 10                           | 60                        | 60 + 45 (n-2)<br>(n = 2, 3, 4, 5...) |
| <b>D-C73C/C80C</b><br><b>D-H7C</b>                  | 5                            | 65                        | 65 + 50 (n-2)<br>(n = 2, 3, 4, 5...) |
| <b>D-B5□/B64</b><br><b>D-G5□/K59□</b>               | 5                            | 75                        | 75 + 55 (n-2)<br>(n = 2, 3, 4, 5...) |
| <b>D-B59W</b>                                       | 10                           |                           |                                      |

Note 1) Auto switch mounting

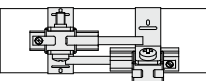
| Auto switch model             | With 2 auto switches<br>Same surface  |  |
|-------------------------------|---|--|
|                               |  <p>The auto switch is mounted by slightly displacing it in a direction (cylinder tube circumferential exterior) so that the auto switch and lead wire do not interfere with each other.</p> |  |
| <b>D-M9□</b><br><b>D-M9□W</b> | Less than 55 stroke <small>Note 2)</small>  |  |
| <b>D-M9□A</b>                 | Less than 60 stroke <small>Note 2)</small>  |  |
| <b>D-A9□</b>                  | Less than 50 stroke <small>Note 2)</small>  |  |

Note 2) Minimum stroke for mounting auto switches in the other mounting types mentioned in note 1.

### Operating Range

| Auto switch model                        | Bore size |    |     |     |    |
|--|-----------|----|-----|-----|----|
|  | 20        | 25 | 32  | 40  | 50 |
| <b>D-M9□(V)/M9□W(V)</b><br><b>D-M9□A</b> | 4.5       | 5  | 4.5 | 5.5 | 5  |
| <b>D-A9□</b>                             | 7         | 6  | 8   | 8   | 8  |
| <b>D-C7□/C80</b><br><b>D-C73C/C80C</b>   | 8         | 10 | 9   | 10  | 10 |
| <b>D-B5□/B64</b>                         | 8         | 10 | 9   | 10  | 10 |
| <b>D-B59W</b>                            | 13        | 13 | 14  | 14  | 14 |

| Auto switch model  | Bore size |     |     |    |     |
|--|-----------|-----|-----|----|-----|
|  | 20        | 25  | 32  | 40 | 50  |
| <b>D-H7□/H7□W</b><br><b>D-H7BA/H7NF</b>                      | 4         | 4   | 4.5 | 5  | 6   |
| <b>D-H7C</b>   | 7         | 8.5 | 9   | 10 | 9.5 |
| <b>D-G5□/K59</b><br><b>D-G5□W/K59W</b><br><b>D-G5NT/G5BA</b> | 4         | 4   | 4.5 | 5  | 6   |
| <b>D-G59F</b>  | 5         | 5   | 5.5 | 6  | 7   |

\* Since this is a guideline including hysteresis, not meant to be guaranteed. (Assuming approximately ±30% dispersion) There may be the case to change substantially depending on an ambient environment.

**MGJ**

**JMGPT**

**MGP**

**MGPW**

**MGQ**

**MGG**

**MGC**

**MGF**

**MGZ**

**MGT**

**D-□**

**-X□**

## Auto Switch Mounting Bracket: Part No.

| Auto switch model                 | Bore size (mm)                               |  |  |  |  |
|-----------------------------------|--|--|--|--|--|
|                                   | 20   | 25   | 32   | 40   | 50   |
| D-M9□(V)<br>D-M9□W(V)<br>D-A9□(V) | Note 1)<br>BMA3-020<br>(A set of a, b, c, d) | Note 1)<br>BMA3-025<br>(A set of a, b, c, d) | Note 1)<br>BMA3-032<br>(A set of a, b, c, d) | Note 1)<br>BMA3-040<br>(A set of a, b, c, d) | Note 1)<br>BMA3-050<br>(A set of a, b, c, d) |
| D-M9□A(V) Note 2)                 | BMA3-020S<br>(A set of b, c, e, f)           | BMA3-025S<br>(A set of b, c, e, f)           | BMA3-032S<br>(A set of b, c, e, f)           | BMA3-040S<br>(A set of b, c, e, f)           | BMA3-050S<br>(A set of b, c, e, f)           |

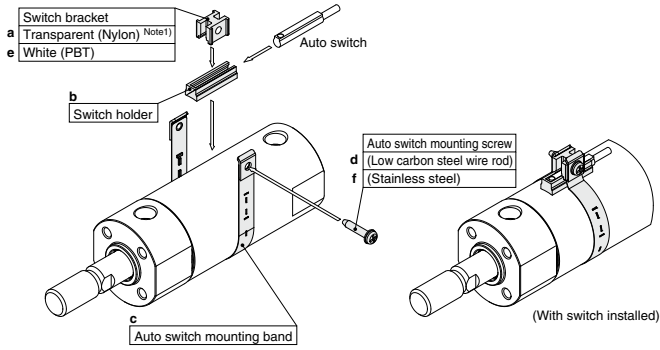

|   |                                  |                                  |                                  |                                  |                                  |
|---|----------------------------------|----------------------------------|----------------------------------|----------------------------------|----------------------------------|
| D-H7□<br>D-H7□W<br>D-H7NF<br>D-C7□/C80<br>D-C73C/C80C     | BMA2-020A<br>(A set of c and d)  | BMA2-025A<br>(A set of c and d)  | BMA2-032A<br>(A set of c and d)  | BMA2-040A<br>(A set of c and d)  | BMA2-050A<br>(A set of c and d)  |
| D-H7BA  | BMA2-020AS<br>(A set of c and f) | BMA2-025AS<br>(A set of c and f) | BMA2-032AS<br>(A set of c and f) | BMA2-040AS<br>(A set of c and f) | BMA2-050AS<br>(A set of c and f) |
| D-B5□/B64<br>D-B59W<br>D-G5□/K59<br>D-G5BA/K59F<br>D-G5NT | BA-01<br>(A set of c and d)      | BA-02<br>(A set of c and d)      | BA-32<br>(A set of c and d)      | BA-04<br>(A set of c and d)      | BA-05<br>(A set of c and d)      |

Note 1) Since the switch bracket (made from nylon) are affected in an environment where alcohol, chloroform, methylamines, hydrochloric acid or sulfuric acid is splashed over, so it cannot be used. Please contact SMC regarding other chemicals.

Note 2) When mounting a D-M9□A(V) type auto switch, if the switch bracket is mounted on the indicator light, it may damage the auto switch. Therefore, be sure to avoid mounting the switch bracket on the indicator light.

### Band Mounting Brackets Set Part No.

| Set part no. | Contents   |
|--------------|--|
| <b>BJ4-1</b> | · Switch bracket (White/PBT)(e)<br>· Switch holder (b)         |
| <b>BJ5-1</b> | · Switch bracket (Transparent/Nylon)(a)<br>· Switch holder (b) |

### [Stainless Steel Mounting Screw]

The following stainless steel mounting screw kit is available. Use it in accordance with the operating environment.

(Since the auto switch mounting bracket is not included, order it separately.)

BBA3: D-B5/B6/G5/K5 types

Note) For details about the BBA3, refer to page 1225.

Note) When the D-G5BA type auto switch is shipped independently, the BBA3 is attached.

Besides the models listed in How to Order, the following auto switches are applicable.  
Refer to pages 1119 to 1245 for detailed specifications.

| Type                    | Model                                | Electrical entry  | Features                                  |
|-------------------------|--------------------------------------|-------------------|---|
| Reed auto switch        | D-C73, C76, B53                      | Grommet (In-line) | —   |
|                         | D-C80                                |                   | Without indicator light                   |
|                         | D-H7A1, H7A2, H7B, G59, G5P, K59     | Grommet (In-line) | —   |
| Solid state auto switch | D-H7BW, H7NW, H7PW, G59W, G5PW, K59W | Grommet (In-line) | Diagnostic indication (2-color indicator) |
|                         | D-H7BA                               |                   | Water resistant (2-color indicator)       |
|                         | D-G5NT                               |                   | With timer                                |

\* For solid state auto switches, auto switches with a pre-wired connector are also available. Refer to pages 1192 and 1193 for details.

\* Normally closed (NC = b contact) solid state auto switches (D-M9□E(V)) are also available. Refer to page 1592-1 for details.





## 1 With Piping Ports for Grease

Symbol  
**-X440**

This type is equipped with Rc 1/8 piping ports for grease on both sides of the guide body.

### How to Order

MGC **Standard How to Order for each series** —X440

With piping port for grease ●

### Specifications

| Applicable series               | MGC                            |
|---------------------------------|--------------------------------|
| Bore size (mm)                  | 20, 25, 32, 40, 50             |
| Fluid                           | Air                            |
| Minimum operating pressure      | 0.15 MPa (Horizontal, No load) |
| Piston speed                    | 50 to 750 mm/s                 |
| Auto switch                     | Mountable                      |
| Specifications other than above | Same as the standard type      |

### Dimensions (Dimensions other than those below are the same as the standard type.)

#### MGC series

ø20 to ø50

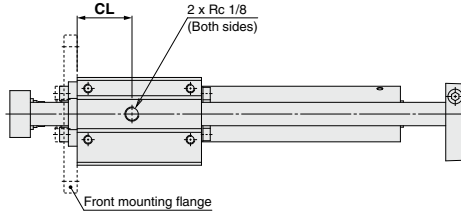

(mm)

| Bore size (mm) | CL   |
|----------------|------|
| 20             | 33   |
| 25             | 35   |
| 32             | 37.5 |
| 40             | 42.5 |
| 50             | 58.5 |

\* The standard grease supply port has a hexagon socket head set screw.

MGJ

JMGP

MGP

MGPW

MGQ

MGG

**MGC**

MGF

MGT

MGT

D-□

-X□



## MGC Series

# Specific Product Precautions

Be sure to read this before handling the products.

Refer to back page 50 for Safety Instructions and pages 3 to 12 for Actuator and Auto Switch Precautions.

### Installations/Adjustment

#### Warning

##### 1. Installing a protective cover (In the case of rear plate)

During mounting, handling and operation, the rear plate makes reciprocating movements. Therefore, pay careful attention not to insert your hand, etc., between the cylinder and the rear plate.

When you are going to fit this product to the outside of your equipment, take preventative measures such as installing a protective cover.

##### MGC Protective cover installation example

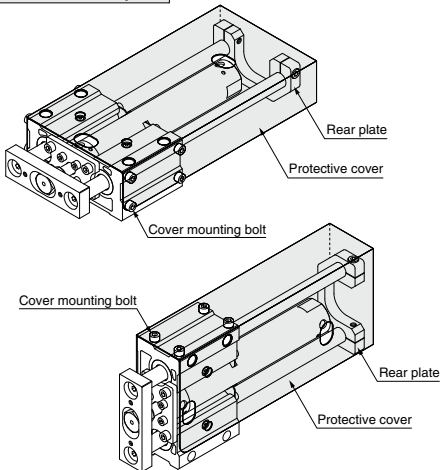

##### 2. Do not open the cushion valve after rotating it numerous times in a row. Though uncommon, there are cases in which the cushion valve may leak air.

The cushion valve should be adjusted by gradually opening it while checking the operation of the cylinder cushion.

#### Caution

##### 1. Use caution that no scratch or dent will be given to the slide part of the guide rod.

Because the outer circumference of the guide rod is manufactured with precise tolerances, even a slight deformation, scratch, or gouge can lead to faulty operation or reduced durability.

##### 2. When fitting the guide body, use the guide body which has high flatness of the fitting surface.

If the guide rod has twisted, operation resistance will become abnormally higher and the bearing will wear at an early stage, thereby resulting in poor performance.

##### 3. Mount in locations where maintenance will be easy.

Ensure enough clearance around the cylinder to allow for unobstructed maintenance and inspection work.

##### 4. Do not adjust the rod stroke by moving the rear plates,

as doing so will cause the rear plates to come into direct contact with the guide body or the bracket mounting bolt. The resulting impact cannot be absorbed easily, the stroke position cannot be maintained, and faulty operation may result.

##### 5. Lubrication

When you are going to oil the bearings, do so by using a nipple so that no foreign matter will be mixed.

For the grease, we recommended using high-quality lithium soap-based grease no. 2.

##### 6. Mounting orientation (In the case of rear plate)

If the guide body is mounted so that it is inclined more than 90°, the rear plate may interfere with the basic cylinder head end due to the deflection of guide rods. Please consult with SMC.

##### 7. Fixing of base cylinder

When the product is mounted and operated in a location with low rigidity, bending moment may be applied to the base cylinder by vibrations generated at the stroke end, causing damage to the cylinder. In such cases, install a support bracket to suppress the vibration of the body of the base cylinder or reduce the piston speed until the body does not vibrate at the stroke end.