

Slider Type/Ball Bushing Bearing

CY1L Series

ø6, ø10, ø15, ø20, ø25, ø32, ø40



CY1L Series Model Selection

E: Kinetic energy of load (J)

$$E = \frac{W}{2} \cdot \left(\frac{V}{1000} \right)^2$$

Es: Allowable kinetic energy for intermediate stop using an air pressure circuit (J)

Ps: Operating pressure limit for intermediate stop using an external stopper, etc. (MPa)

Pv: Maximum operating pressure for vertical operation (MPa)

W_A: Allowable load mass based on these operating conditions (kg)

W_v: Allowable load mass for vertical operation (kg)

F_A: Allowable drive resisting force at pusher (kg)

σ: Stroke coefficient

$$\sigma = \frac{\text{Load mass in stroke}}{\text{Maximum load mass}}$$

Operating Conditions

- W: Load mass (kg)
- P: Operating pressure (MPa)
- L_o: Distance from slide block mounting surface to workpiece center of gravity (cm)
- Mode of operation (Horizontal, Inclined, Vertical)
- F: Drive resisting force (kg)
- V: Speed (mm/s)
- Stroke (mm)
- W_v: Allowable load mass for vertical operation (kg)
- P_v: Maximum operating pressure for vertical operation (MPa)

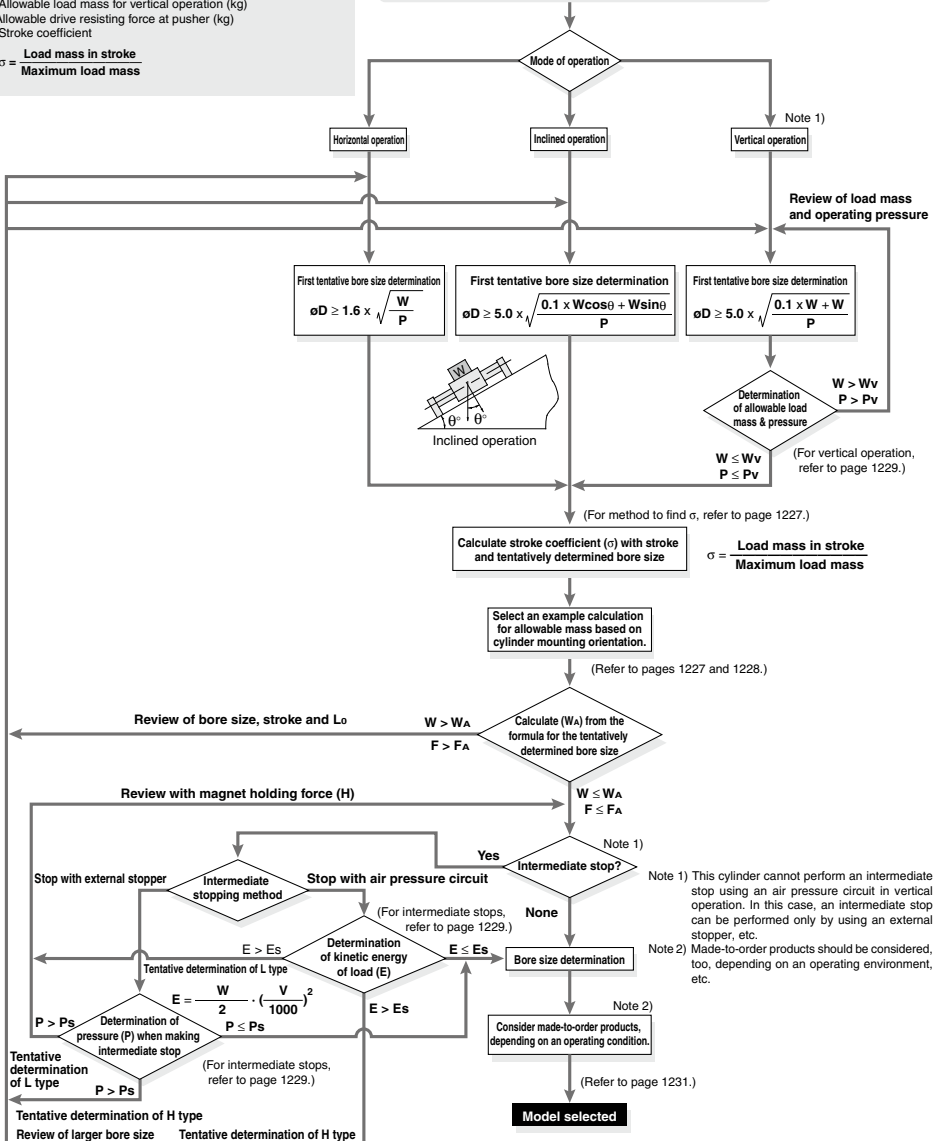

Caution on Design (1)

How to Find σ when Selecting the Allowable Load Mass

Since the maximum load mass with respect to the cylinder stroke changes as shown in the table below, σ should be considered as a coefficient determined in accordance with each stroke.

Example) CY1L25□-650

- (1) Maximum load mass = 20 kg
- (2) Load mass for 650 st = 13.6 kg
- (3) $\sigma = \frac{13.6}{20} = 0.68$ is the result.

Calculation Formula for σ ($\sigma \leq 1$)

ST: Stroke (mm)

Model	CY1L6	CY1L10	CY1L15
$\sigma =$	1	$\frac{10^{(0.88 - 1.3 \times 10^{-3} \times ST)}}{3}$	$\frac{10^{(1.5 - 1.3 \times 10^{-3} \times ST)}}{7}$

Model	CY1L20	CY1L25	CY1L32
$\sigma =$	$\frac{10^{(1.71 - 1.3 \times 10^{-3} \times ST)}}{12}$	$\frac{10^{(1.98 - 1.3 \times 10^{-3} \times ST)}}{20}$	$\frac{10^{(2.26 - 1.3 \times 10^{-3} \times ST)}}{30}$

Model	CY1L40
$\sigma =$	$\frac{10^{(2.48 - 1.3 \times 10^{-3} \times ST)}}{50}$

Note) Calculate with $\sigma = 1$ for all applications up to $\phi 10 - 300$ mmST, $\phi 15 - 500$ mmST, $\phi 20 - 500$ mmST, $\phi 25 - 500$ mmST, $\phi 32 - 600$ mmST and $\phi 40 - 600$ mmST.

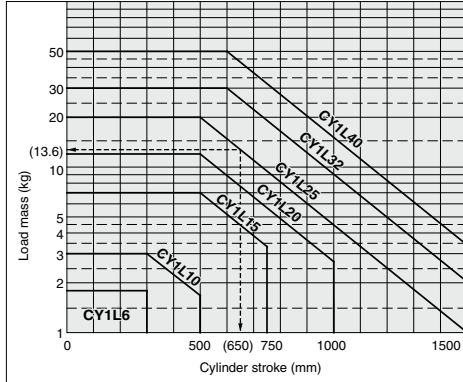

Examples of Allowable Load Mass Calculation Based on Cylinder Mounting Orientation

1. Horizontal Operation (Floor mounting)

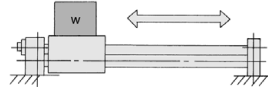

Maximum Load Mass (Center of slide block) (kg)	6	10	15	20	25	32	40
Bore size (mm)	6	10	15	20	25	32	40
Max. load mass (kg)	1.8	3	7	12	20	30	50
Stroke (Max)	Up to 300 st	Up to 300 st	Up to 500 st	Up to 500 st	Up to 500 st	Up to 600 st	Up to 600 st

The above maximum load mass values will change with the stroke length for each cylinder size, due to limitation from warping of the guide shafts. (Take note of the coefficient σ .)

Moreover, depending on the operating direction, the allowable load mass may be different from the maximum load mass.

2. Horizontal Operation (Wall mounting)

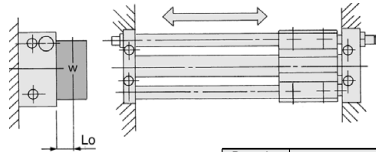

Lo: Distance from mounting surface to load center of gravity (cm)

Bore size (mm)	Allowable load mass (W _A) (kg)
6	$\sigma \cdot 6.48 - 6.8 + 2Lo$
10	$\sigma \cdot 15.0 - 8.9 + 2Lo$
15	$\sigma \cdot 45.5 - 11.3 + 2Lo$
20	$\sigma \cdot 101 - 13.6 + 2Lo$
25	$\sigma \cdot 180 - 15.2 + 2Lo$
32	$\sigma \cdot 330 - 18.9 + 2Lo$
40	$\sigma \cdot 624 - 22.5 + 2Lo$

3. Vertical Operation

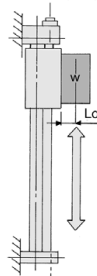

Bore size (mm)	Allowable load mass (W _V) (kg)
6	$\sigma \cdot 1.53 - 1.6 + Lo$
10	$\sigma \cdot 5.00 - 1.95 + Lo$
15	$\sigma \cdot 15.96 - 2.4 + Lo$
20	$\sigma \cdot 31.1 - 2.8 + Lo$
25	$\sigma \cdot 54.48 - 3.1 + Lo$
32	$\sigma \cdot 112.57 - 3.95 + Lo$
40	$\sigma \cdot 212.09 - 4.75 + Lo$

Lo: Distance from mounting surface to load center of gravity (cm)

Note) Operating pressure should be equal to or less than the maximum operating pressure in the article, "Vertical Operation" listed on page 1229.

Caution on Design (2)

Example of Allowable Load Mass Calculation Based on Cylinder Mounting Orientation

4. Inclined Operation (In operating direction)

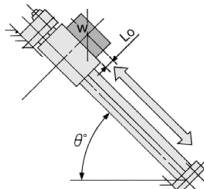

Angle	up to 45°	up to 60°	up to 75°	up to 90°
k	1	0.9	0.8	0.7

Angle coefficient (k) : k = [to 45° (= θ)] = 1,
[to 60°] = 0.9, [to 75°] = 0.8,
[to 90°] = 0.7

Lo: Distance from mounting surface to load center of gravity (cm)

Bore size (mm)	Allowable load mass (W _A) (kg)
6	$\sigma 4.05 \cdot K$
	$1.7 \cos \theta + 2 (1.6 + Lo) \sin \theta$
10	$\sigma 10.2 \cdot K$
	$2.8 \cos \theta + 2 (1.95 + Lo) \sin \theta$
15	$\sigma 31.1 \cdot K$
	$2.9 \cos \theta + 2 (2.4 + Lo) \sin \theta$
20	$\sigma 86.4 \cdot K$
	$6 \cos \theta + 2 (2.8 + Lo) \sin \theta$
25	$\sigma 105.4 \cdot K$
	$3.55 \cos \theta + 2 (3.1 + Lo) \sin \theta$
32	$\sigma 178 \cdot K$
	$4 \cos \theta + 2 (3.95 + Lo) \sin \theta$
40	$\sigma 361.9 \cdot K$
	$5.7 \cos \theta + 2 (4.75 + Lo) \sin \theta$

5. Inclined Operation (At a right angle to operating direction)

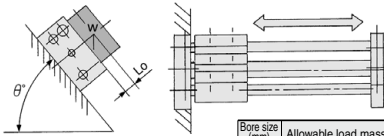

Lo: Distance from mounting surface to load center of gravity (cm)

Bore size (mm)	Allowable load mass (W _A) (kg)
6	$\sigma 6.48$
	$3.6 + 2 (1.6 + Lo) \sin \theta$
10	$\sigma 15$
	$5 + 2 (1.95 + Lo) \sin \theta$
15	$\sigma 45.5$
	$6.5 + 2 (2.4 + Lo) \sin \theta$
20	$\sigma 115$
	$8 + 2 (2.8 + Lo) \sin \theta$
25	$\sigma 180$
	$9 + 2 (3.1 + Lo) \sin \theta$
32	$\sigma 330$
	$11 + 2 (3.95 + Lo) \sin \theta$
40	$\sigma 624$
	$13 + 2 (4.75 + Lo) \sin \theta$

6. Load Center Offset in Operating Direction (Lo)

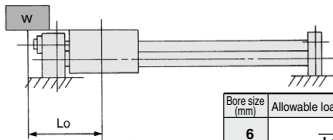

Lo: Distance from center of side block to load's center of gravity (cm)

Bore size (mm)	Allowable load mass (W _A) (kg)
6	$\sigma 2$
	$Lo + 1.7$
10	$\sigma 5.6$
	$Lo + 2.8$
15	$\sigma 13.34$
	$Lo + 2.9$
20	$\sigma 43.2$
	$Lo + 6$
25	$\sigma 46.15$
	$Lo + 3.55$
32	$\sigma 80$
	$Lo + 4$
40	$\sigma 188.1$
	$Lo + 5.7$

7. Horizontal Operation (Pushing load, Pusher)

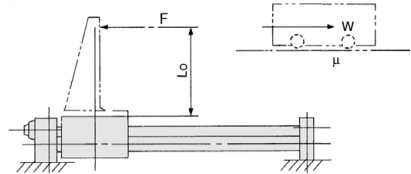

F: Drive (from slide block to position Lo) resistance force $W \times \mu$ (kg)
Lo: Distance from mounting surface to load center of gravity (cm)
 μ : Friction coefficient

Bore size (mm)	6	10	15	20
Allowable drive resisting force (F _A) (kg)	$\frac{\sigma 2.72}{1.6 + Lo}$	$\frac{\sigma 5.55}{1.95 + Lo}$	$\frac{\sigma 15.96}{2.4 + Lo}$	$\frac{\sigma 41.7}{2.8 + Lo}$
Bore size (mm)	25	32	40	
Allowable drive resisting force (F _A) (kg)	$\frac{\sigma 58.9}{3.1 + Lo}$	$\frac{\sigma 106.65}{3.95 + Lo}$	$\frac{\sigma 228}{4.75 + Lo}$	

8. Horizontal Operation (Load, Lateral offset Lo)

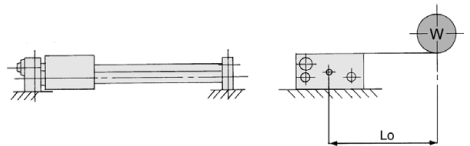

Lo: Distance from center of side block to load's center of gravity (cm)

Bore size (mm)	6	10	15	20
Allowable load mass (W _A) (kg)	$\frac{\sigma 6.48}{3.6 + Lo}$	$\frac{\sigma 15}{5 + Lo}$	$\frac{\sigma 45.5}{6.5 + Lo}$	$\frac{\sigma 80.7}{8 + Lo}$
Bore size (mm)	25	32	40	
Allowable load mass (W _A) (kg)	$\frac{\sigma 144}{9 + Lo}$	$\frac{\sigma 275}{11 + Lo}$	$\frac{\sigma 520}{13 + Lo}$	

Caution on Design (3)

Vertical Operation

When operating a load vertically, it should be operated within the allowable load mass and maximum operating pressures shown in the table below. Use caution, as operating above the prescribed values may lead to dropping of the load.

When the cylinder is mounted vertically or sidelong, sliders may move downwards due to the self-weight or workpiece mass. If an accurate stopping position is required at the stroke end or the middle-stroke, use an external stopper to secure accurate positioning.

Bore size (mm)	Model	Allowable load mass (Wv) (kg)	Maximum operating pressure (Pv) (MPa)
6	CY1L 6H	1.0	0.55
10	CY1L10H	2.7	0.55
15	CY1L15H	7.0	0.65
	CY1L15L	4.1	0.40
20	CY1L20H	11.0	0.65
	CY1L20L	7.0	0.40
25	CY1L25H	18.5	0.65
	CY1L25L	11.2	0.40
32	CY1L32H	30.0	0.65
	CY1L32L	18.2	0.40
40	CY1L40H	47.0	0.65
	CY1L40L	29.0	0.40

Note 1) Use caution, since the magnetic coupling may be dislocated if it is used over the maximum operating pressure.

Note 2) Allowable load mass above indicates the maximum load mass when loaded. The actual loadable mass must be determined referring to the flow chart in the Model Selection 1.

Intermediate Stop

1. Intermediate stopping of load with an external stopper, etc.

When stopping a load in mid-stroke using an external stopper (adjusting bolt, etc.), operate within the operating pressure limits shown in the table below. Use caution, as operation at a pressure exceeding these limits can result in breaking of the magnetic coupling.

Bore size (mm)	Model	Operating pressure limit for intermediate stop (Ps) (MPa)
6	CY1L 6H	0.55
10	CY1L10H	0.55
15	CY1L15H	0.65
	CY1L15L	0.40
20	CY1L20H	0.65
	CY1L20L	0.40
25	CY1L25H	0.65
	CY1L25L	0.40
32	CY1L32H	0.65
	CY1L32L	0.40
40	CY1L40H	0.65
	CY1L40L	0.40

2. Intermediate stopping of load with an air pressure circuit

When stopping a load using an air pressure circuit, operate at or below the kinetic energy shown in the table below. Use caution, as operation when exceeding the allowable value can result in breaking of the magnetic coupling.

(Reference values)

Bore size (mm)	Model	Allowable kinetic energy for intermediate stop (Es) (J)
6	CY1L 6H	0.007
10	CY1L10H	0.03
15	CY1L15H	0.13
	CY1L15L	0.076
20	CY1L20H	0.24
	CY1L20L	0.16
25	CY1L25H	0.45
	CY1L25L	0.27
32	CY1L32H	0.88
	CY1L32L	0.53
40	CY1L40H	1.53
	CY1L40L	0.95

Magnetically Coupled Rodless Cylinder Slider Type: Ball Bushing Bearing

CY1L Series

ø6, ø10, ø15, ø20, ø25, ø32, ø40

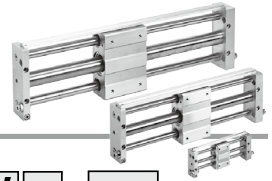

How to Order

Ball Bushing Bearing **CY1L 25** **H** - **300** - **J79W** -

Slider type
(Ball bushing bearing)

Bore size

6	6 mm	25	25 mm
10	10 mm	32	32 mm
15	15 mm	40	40 mm
20	20 mm		

Port thread type

Symbol	Type	Bore size
Nil	M thread	ø6, ø10, ø15
	Rc	ø20, ø25, ø32, ø40
TN	NPT	ø32, ø40
TF	G	

Magnetic holding force

Refer to page 1231 for specifications.

Standard stroke

Refer to "Standard Stroke" on page 1231.

Auto switch

Nil	Without auto switch (Built-in magnet)
-----	--

* For the applicable auto switch model, refer to the table below.

Number of auto switches

Nil	2 pcs.
S	1 pc.
n	"n" pcs.

Adjustment type

Nil	With adjusting bolt
B	With shock absorbers (2 pcs.)
BS	With shock absorber (With plate A) * Installed on side A at time of shipment.

Shock Absorbers

Type	Bore size (mm)				
	6	10, 15	20	25	32, 40
Standard (shock absorber RB series)	RB0805	RB1006	RB1411	RB2015	
Shock absorber soft type RJ series type (-XB22)	RJ0805	RJ0806H	RJ1007H	RJ1412H	—

* The shock absorber service life is different from that of the CY1L cylinder.

Refer to "Specific Product Precautions" for each shock absorber for the replacement period.

* The shock absorber soft type RJ series type (-XB22) is a made to order specification. For details, refer to page 1468.

Applicable Auto Switches Refer to pages 1289 to 1383 for further information on auto switches.

Type	Special function	Electrical entry	Indicator light	Wiring (Output)	Load voltage		Auto switch model		Lead wire length (m) *				Pre-wired connector	Applicable load			
					DC	AC	Perpendicular	In-line	0.5 (Nil)	3 (L)	5 (Z)	None (N)					
									●	●	○	—					
Solid state auto switch	—	Grommet	Yes	3-wire (NPN)	5 V, 12 V	—	F7NV	F79	●	●	○	—	○	IC circuit			
				3-wire (PNP)					12 V	●	●	○	—		○		
		Connector		2-wire	—		●	●		●	●	—	○				
	Diagnostic indication (2-color indicator)	Grommet		3-wire (NPN)	24 V		5 V, 12 V	F7NWW	F79W	●	●	○	—		○	IC circuit	
				3-wire (PNP)				—	F7PW	●	●	○	—		○		
		Water resistant (2-color indicator)		Grommet	2-wire		12 V	F7BWW	F79W	●	●	○	—		○		—
			4-wire (NPN)		5 V, 12 V			—	F79F	●	●	○	—		○		
Read auto switch	—	Grommet	Yes	3-wire (NPN equivalent)		—	5 V	—	A76H	●	●	—	—	—	IC circuit		
				Connector	2-wire	—	—	200 V	A72	A72H	●	●	—	—		—	
						—	—	100 V	A73	A73H	●	●	●	—			—
		No		No	No	24 V	5 V, 12 V	100 V or less	A80	A80H	●	●	—	—		—	
							12 V	—	A73C	—	●	●	●	—		—	—
Connector	Yes	5 V, 12 V	—	A80C	—	●	●	●	●	—	—	—	IC circuit				

** Water resistant type auto switches can be mounted on the above models, but in such case SMC cannot guarantee water resistance. Consult with SMC regarding water resistant types with the above model numbers.

* Lead wire length symbols: 0.5 m..... Nil (Example) J79W
3 m..... L (Example) J79WL
5 m..... Z (Example) J79WZ
None..... N (Example) J79CN

* Solid state auto switches marked with "○" are produced upon receipt of order.

• Since there are other applicable auto switches than listed, refer to page 1234 for details.

• For details about auto switches with pre-wired connector, refer to pages 1358 and 1359.

* Auto switches are shipped together, (but not assembled).

Specifications

Symbol

Rubber bumper
(Magnet type)



Easy piping and wiring

Hollow shafts are used, and centralization of ports on one side makes piping easy. Auto switches can be mounted through the use of special switch rails.

Shock absorbers and adjusting bolt are standard equipment

Impacts at stroke end due to high speed use can be absorbed, and fine adjustment of the stroke is possible.



Made to Order: Individual Specifications
(For details, refer to pages 1252 and 1253.)

Symbol	Specifications
-X116	Hydro specifications
-X168	Helical insert thread specifications
-X322	Outside of cylinder tube with hard chrome plated
-X431	Auto switch rails on both side faces (with 2 pcs.)

Made to Order Specifications

[Click here for details](#)

Symbol	Specifications
-XB9	Low speed cylinder (15 to 50 mm/s)
-XB13	Low speed cylinder (7 to 50 mm/s)
-XB22	Shock absorber soft type RJ series type

Amount of Adjustment by Adjusting Bolt

CY1L

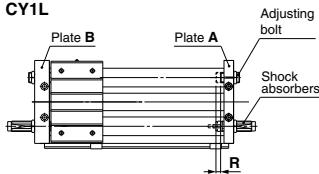

Bore size (mm)	Amount of adjustment by adjusting bolt: R (mm)	
	Single side	Both sides
6	6	12
10	5.5	11
15	3.5	7
20	5.5	11
25	5	10
32	5.5	11
40	4.5	9

- * Since the cylinder is in an intermediate stop condition when stroke adjustment is performed, use caution regarding the operating pressure and the kinetic energy of the load.
- * The amount of adjustment for adjustment bolts is the total amount when adjusted on both plate ends. For the adjustment on a single plate end, the amount of adjustment is half of the figures in the table above.
- * Adjust the stroke adjustment with an adjustment bolt. It cannot be adjusted by a shock absorber.

Bore size (mm)	6	10	15	20	25	32	40	
Fluid	Air							
Proof pressure	1.05 MPa							
Maximum operating pressure	0.7 MPa							
Minimum operating pressure	0.18 MPa							
Ambient and fluid temperature	-10 to 60°C (No freezing)							
Piston speed *	50 to 500 mm/s							
Cushion	Rubber bumper/Shock absorber							
Lubrication	Not required (Non-lube)							
Stroke length tolerance (mm)	0 to 250 st: $^{+1.0}_0$, 251 to 1000 st: $^{+1.4}_0$, 1001 st and up: $^{+1.8}_0$							
Holding force (N)	Type H	19.6	53.9	137	231	363	588	922
	Type L	-	-	81.4	154	221	358	569
Standard equipment	Auto switch mounting rail							

* In the case of setting an auto switch at the intermediate position, the maximum piston speed is subject to restrict for detection upon the response time of a load (Relays, Sequence controller, etc.).

Standard Stroke

Bore size (mm)	Standard stroke (mm)	Maximum available stroke (mm)
6	50, 100, 150, 200	300
10	50, 100, 150, 200, 250, 300	500
15	50, 100, 150, 200, 250, 300, 350 400, 450, 500	750
20	100, 150, 200, 250, 300, 350 400, 450, 500, 600, 700, 800	1000
25		1500
32	100, 150, 200, 250, 300, 350 400, 450, 500, 600, 700, 800 900, 1000	1500
40		1500

Note) Intermediate stroke is available in 1 mm increments.

Weight

Number of magnets	Bore size (mm)							
	6	10	15	20	25	32	40	
Basic weight	CY1L□H	0.324	0.580	1.10	1.85	2.21	4.36	4.83
	CY1L□L	—	—	1.02	1.66	2.04	4.18	4.61
Additional weight per each 50mm of stroke	0.044	0.077	0.104	0.138	0.172	0.267	0.406	

Calculation

(Example) CY1L32H-500

• Basic weight 4.36 kg • Additional weight 0.267/50 st • Cylinder stroke 500 st
4.36 + 0.267 x 500 ÷ 50 = 7.03 kg

Shock Absorber Specifications

Refer to the RB series in the **Web Catalog** for the details on shock absorbers.

Applicable rodless cylinder	Bore size (mm)				
	6 CY1L10 15	10 CY1L20	15 CY1L25	20 CY1L32 40	
Shock absorber model	RB0805	RB1006	RB1411	RB2015	
Maximum energy absorption: (J)	0.98	3.92	14.7	58.8	
Stroke absorption: (mm)	5	6	11	15	
Collision speed: (m/s)	0.05 to 5				
Max. operating frequency: (cycle/min) *	80	70	45	25	
Ambient temperature range	-10 to 80 °C				
Spring force: (N)	Extended	1.96	4.22	6.86	8.34
	Retracted	3.83	6.18	15.3	20.50

* It denotes the values at the maximum energy absorption per one cycle. Therefore, the operating frequency can be increased according to the energy absorption.

The shock absorber service life is different from that of the CY1L cylinder. Refer to the Specific Product Precautions for the replacement period.

CY1L Series

Construction

Slider type/Ball bushing bearing

CY1L6

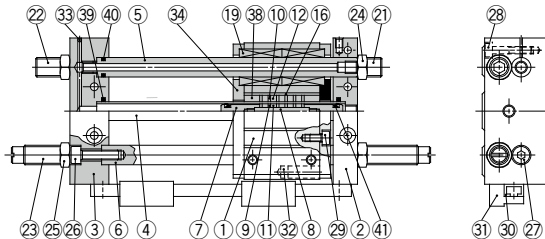

CY1L10 to 40

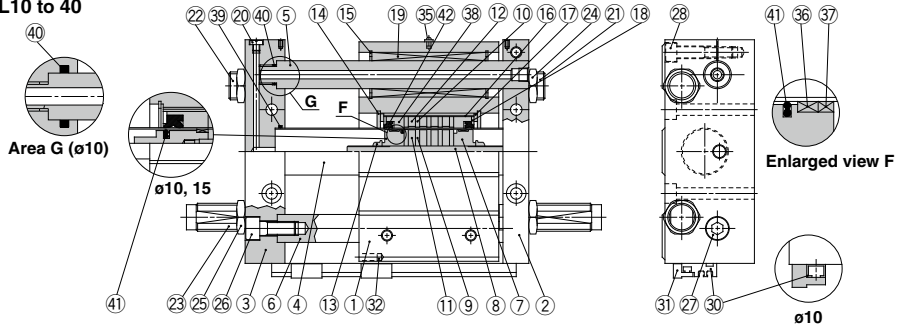

Component Parts

No.	Description	Material	Note
1	Slide block	Aluminum alloy	Anodized
2	Plate A	Aluminum alloy	Anodized
3	Plate B	Aluminum alloy	Anodized
4	Cylinder tube	Stainless steel	
5	Guide shaft A	Carbon steel	Hard chrome plated
6	Guide shaft B	Carbon steel	Hard chrome plated
7	Piston	Aluminum alloy ^{Note 1)}	Chromated
8	Shaft	Stainless steel	
9	Piston side yoke	Rolled steel	Zinc chromated
10	External slider side yoke	Rolled steel	Zinc chromated
11	Magnet A	—	
12	Magnet B	—	
13	Piston nut	Carbon steel	Zinc chromated ø25 to ø40
14	Retaining ring	Carbon tool steel	Phosphate coated
15	Retaining ring	Carbon tool steel	Phosphate coated
16	External slider tube	Aluminum alloy	
17	Slider spacer	Rolled steel	Nickel plated
18	Spacer	Rolled steel	Nickel plated
19	Ball bushing	—	
20	Plug	Brass	Nickel plated ø25 to ø40 only
21	Adjusting bolt A	Chromium molybdenum steel	Nickel plated
22	Adjusting bolt B	Chromium molybdenum steel	Nickel plated
23	Shock absorber	—	
24	Hexagon nut	Carbon steel	Nickel plated
25	Hexagon nut	Carbon steel	Nickel plated
26	Hexagon socket head cap screw	Chromium molybdenum steel	Nickel plated
27	Hexagon socket head cap screw	Chromium molybdenum steel	Nickel plated
28	Hexagon socket head cap screw	Chromium molybdenum steel	Nickel plated

Note 1) Brass for ø6

No.	Description	Material	Note
29	Hexagon socket head cap screw	Chromium molybdenum steel	Nickel plated
30	Switch mounting rail	Aluminum alloy	
31	Auto switch	—	
32	Magnet for auto switch	—	
33	Steel ball	—	ø6, ø10, ø15 only
34	Side cover	Carbon steel	ø6 only
35	Grease cup	Carbon steel	ø15 or larger
36*	Wear ring A	Special resin	
37*	Wear ring	Special resin	
38*	Wear ring B	Special resin	
39*	Cylinder tube gasket	NBR	
40*	Guide shaft gasket	NBR	
41*	Piston seal	NBR	
42*	Scrapers	NBR	

Replacement Parts: Seal Kit

Bore size (mm)	Kit no.	Contents
6	CY1S6-PS-N	Set of nos. above 38, 39, 40, 41
10	CY1L10-PS-N	Set of nos. above 38, 39, 40, 41, 42
15	CY1L15-PS-N	Set of nos. above 36, 37, 38, 39, 40, 41, 42
20	CY1L20-PS-N	
25	CY1L25-PS-N	
32	CY1L32-PS-N	
40	CY1L40-PS-N	

Note 1) Seal kit includes 38, 39, 40, 41 for ø6, 36, 38 to 42 are for ø10, ø15.
36 to 42 are for ø20 to ø40. Order the seal kit, based on each bore size.

Note 2) ø6: Same for CY1S6

Note 3) For replacement of the ø10 wear ring A, contact SMC or your nearest sales representative.

* Seal kit includes a grease pack (ø6, ø10: 5 and 10 g, ø15 to ø40: 10 g).
Order with the following part number when only the grease pack is needed.
Grease pack part no. for ø6, ø10: GR-F-005 (5 g) for external sliding parts,
GR-S-010 (10 g) for tube interior
Grease pack part no. for ø15 to ø40: GR-S-010 (10 g)

Magnetically Coupled Rodless Cylinder Slider Type: Ball Bushing Bearing **CY1L Series**

Dimensions

Slider type/Ball bushing bearing

CY1L6/10

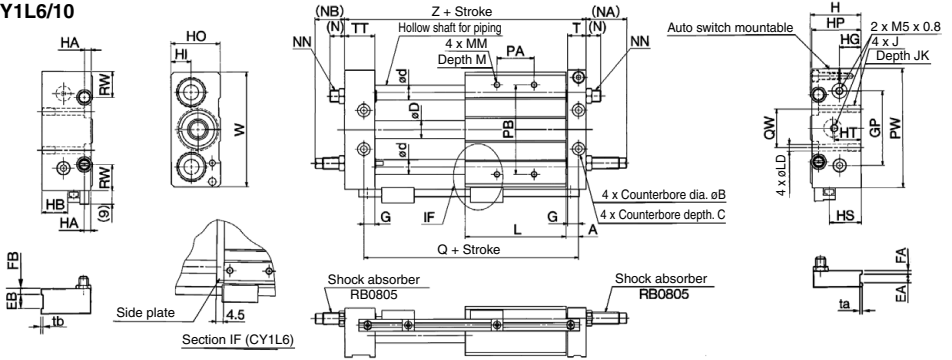

Model	A	B	C	D	d	EA	EB	FA	FB	G	GP	H	HA	HB	HG	HI	HO	HP	HS	HT	J	JK
CY1L6	7	6.5	3	7.6	8	—	—	—	6	36	27	5	10	11	9	25	26	14	16	M4 x 0.7	6.5	
CY1L10	8.5	8	4	12	10	6	12	3	5	7.5	50	34	6	17.5	14.5	13.5	33	33	21.5	18	M5 x 0.8	9.5

Model	L	LD	M	MM	(N)	(NA)	(NB)	NN	PA*	PB	PW	Q	QW	RW	T	TT	ta	tb	W	Z
CY1L6	40	3.5	6	M4 x 0.7	11	30	24	M8 x 1.0	24	40	60	54	20	12	10	16	—	—	56	68
CY1L10	68	4.3	8	M4 x 0.7	10.5	27	19	M8 x 1.0	30	60	80	85	26	17.5	12.5	20.5	0.5	1.0	77	103

* PA dimensions are for split from center.

CY1L15/20/25/32/40

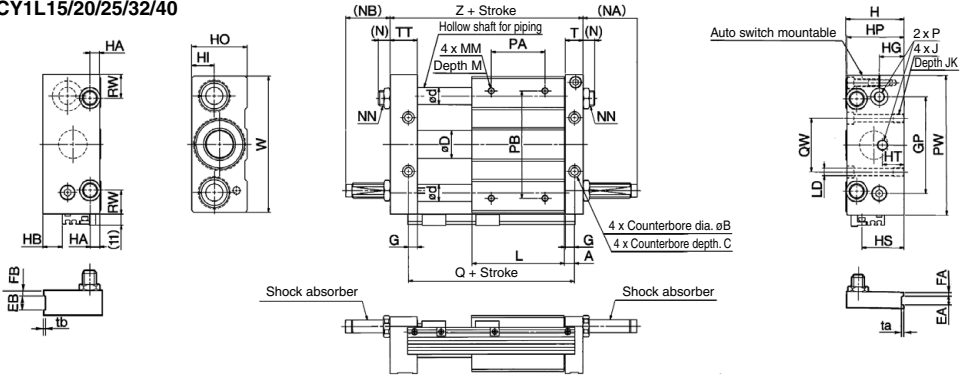

Model	A	B	C	D	d	EA	EB	FA	FB	G	GP	H	HA	HB	HG	HI	HO	HP	HS	HT	J	JK	L	LD	
CY1L15	7.5	9.5	5	16.6	12	6	13	3	6	6.5	65	40	6.5	4	16	14	38	39	25	16	M6 x 1.0	9.5	75	5.6	
CY1L20	9.5	9.5	5.2	21.6	16	—	—	—	8.5	80	46	9	10	18	16	44	45	31	20	—	M6 x 1.0	10	86	5.6	
CY1L25	9.5	11	6.5	26.4	16	8	14	4	7	8.5	90	54	9	18	23	21	52	53	39	20	M8 x 1.25	10	86	7	
CY1L32	10.5	14	8	33.6	20	8	16	5	7	9.5	110	66	12	26.5	26.5	64	64	47.5	25	—	M10 x 1.5	15	100	9.2	
CY1L40	11.5	14	8	41.6	25	10	20	5	10	10.5	130	78	12	35	30.5	28.5	76	74	56	30	—	M10 x 1.5	15	136	9.2

Model	M	MM	(N)	(NA)	(NB)	NN	P	PA*	PB	PW	Q	QW	RW	T	ta	tb	TT	W	Z	Shock absorber
CY1L15	8	M5 x 0.8	8.5	27	17	M8 x 1.0	M5 x 0.8	45	70	95	90	30	15	12.5	0.5	1.0	22.5	92	112	RB0805
CY1L20	10	M6 x 1.0	10.5	29	20	M10 x 1.0	Rc 1/8	50	90	120	105	40	28	16.5	—	—	25.5	117	130	RB1006
CY1L25	10	M6 x 1.0	12.5	49	40	M14 x 1.5	Rc 1/8	60	100	130	105	50	22	16.5	0.5	1.0	25.5	127	130	RB1411
CY1L32	12	M8 x 1.25	13.5	52	42	M20 x 1.5	Rc 1/8	70	120	160	121	60	33	18.5	0.5	1.0	28.5	157	149	RB2015
CY1L40	12	M8 x 1.25	12.5	51	36	M20 x 1.5	Rc 1/4	90	140	190	159	84	35	20.5	1.0	1.0	35.5	187	194	

* PA dimensions are for split from center.

CY1L Series Auto Switch Mounting

Proper Auto Switch Mounting Position (Detection at stroke end)

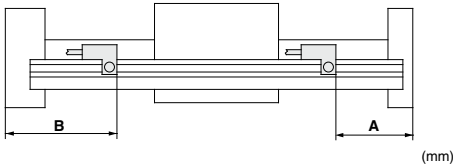

Bore size (mm)	Applicable auto switch					
	D-A73/A80		D-A72 D-A7□H/A80H D-A73C/A80C D-F7□J/J79 D-F7□V/J79C D-F7□W/J79W D-F7□WV D-F7BA/F7BAV D-F79F		D-F7NT	
	A	B	A	B	A	B
6	23	45	23.5	44.5	28.5	39.5
10	58	45	58.5	44.5	63.5	39.5
15	65	47	65.5	46.5	70.5	41.5
20	76	54	76.5	53.5	81.5	48.5
25	76	54	76.5	53.5	81.5	48.5
32	92	57	92.5	56.5	97.5	51.5
40	130	64	130.5	63.5	135.5	58.5

Note 1) 50 mm is the minimum stroke available with 2 auto switches mounted.
In the case of a stroke less than this, please contact SMC.

Note 2) Adjust the auto switch after confirming the operating conditions in the actual setting.

Mounting of Auto Switch

When mounting an auto switch, the auto switch mounting screw should be screwed into a hexagon nut (M3 x 0.5) which has been inserted into the groove of the switch mounting rail. (Tightening torque: Approx. 0.5 to 0.7 N·m)

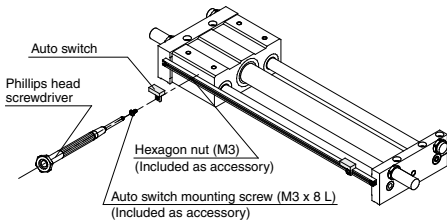

Operating Range

Auto switch model	Bore size (mm)						
	6	10	15	20	25	32	40
D-A7□/A8□	6	6	6	6	6	6	6
D-F7□/J7□	3	3	4	3	3	3	3.5
D-F79F	4.5	4.5	4.5	4.5	4.5	4.5	4.5

* Since this is a guideline including hysteresis, not meant to be guaranteed. (Assuming approximately ±30% dispersion)
There may be the case it will vary substantially depending on an ambient environment.

Other than the models listed in "How to Order", the following auto switches are applicable.
For detailed specifications, refer to page 1340.

Type	Model	Electrical entry (Fetching direction)	Features
Solid state auto switch	D-F7NT	Grommet (In-line)	With timer

* With pre-wired connector is available for D-F7NT type, too.
For details, refer to pages 1358 and 1359.



CY1L Series Specific Product Precautions

Be sure to read this before handling the products. Refer to page 8 for safety instructions and pages 9 to 18 for actuator and auto switch precautions.

Operation

⚠ Warning

1. **Be aware of the space between the plates and the slide block.**
Take sufficient care to avoid getting your hands or fingers caught when the cylinder is operated.
2. **Do not apply a load to a cylinder which is greater than the allowable value stated in the “Model Selection” pages.**
This may cause malfunctions.
3. **Do not use the cylinder in an environment where the cylinder is expose to moisture, adhesive foreign matter, dust or liquid such as water or cutting fluid.**
If the cylinder is used in an environment where the lubrication of the cylinders sliding parts is compromised, please consult SMC.
4. **When applying grease to the cylinder, use the grease that has already been applied to the product. Contact SMC for available grease packs.**

Mounting

⚠ Caution

1. **Avoid operation with the external slider fixed to the mounting surface.**
The cylinder should be operated with the plates fixed to the mounting surface.
2. **Make sure that the cylinder mounting surface is a flatness of 0.2 mm or less.**
If the flatness of the cylinder mounting surface is not appropriate, 2 guide shafts may be twisted. This may adversely affect the operating conditions and shorten the service life due to the increase of sliding resistance and the early abrasion of bearings.
The cylinder mounting surface must be a flatness of 0.2 mm or less, and the cylinder must be mounted as it smoothly operates through the full stroke at the minimum operating pressure (0.18 MPa or less).

Service Life and Replacement Period of Shock Absorber

⚠ Caution

1. **Allowable operating cycle under the specifications set in this catalog is shown below.**
1.2 million times RB08□□
2 million times RB10□□ to RB2725
Note) Specified service life (suitable replacement period) is the value at room temperature (20 to 25°C).
The period may vary depending on the temperature and other conditions. In some cases the absorber may need to be replaced before the allowable operating cycle above.

Disassembly and Maintenance

⚠ Warning

1. **Use caution as the attractive power of the magnets is very strong.**
When removing the external slider and piston slider from the cylinder tube for maintenance, etc., handle with caution, since the magnets installed in each slider have a very strong attractive force.

⚠ Caution

1. **Use caution when removing the external slider, as the piston slider will be directly attracted to it.**
When removing the external slider or piston slider from the cylinder tube, first force the sliders out of their magnetically coupled positions, and then remove them individually when there is no longer any holding force. If they are removed while still magnetically coupled, they will be directly attracted to one another and will not come apart.
2. **Since the magnetic holding force can be changed (for example, from CY1L25L to CY1L25H), please contact SMC if this is necessary.**
3. **Do not disassemble the magnetic components (piston slider, external slider).**
This can cause a loss of holding force and malfunction.
4. **When disassembling to replace the seals and wear ring, refer to the separate disassembly instructions.**
5. **Use caution to the direction of the external slider and the piston slider.**
Since the external slider and piston slider are directional for $\phi 6$, $\phi 10$ and holding force type L, refer to the figures below when performing disassembly or maintenance. Put the external slider and piston slider together, and insert the piston slider into the cylinder tube so that they will have the correct positional relationship as shown in Fig. (1). If they align as shown in Fig. (2), insert the piston slider after turning it around 180°. If the direction is not correct, it will be impossible to obtain the specified holding force.

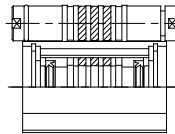

Fig. (1) Correct position



Fig. (2) Incorrect position

Example of $\phi 15$ with holding force type L

Linear Guide Type

CY1H Series

Single Axis Type: $\varnothing 10$, $\varnothing 15$, $\varnothing 20$, $\varnothing 25$ /Double Axis Type: $\varnothing 25$, $\varnothing 32$



CY1H Series Model Selection

E: Kinetic energy of load (J)

$$E = \frac{W}{2} \cdot \left(\frac{V}{1000} \right)^2$$

Es: Allowable kinetic energy for intermediate stop using an air pressure circuit (J)

Ps: Operating pressure limit for intermediate stop using an external stopper, etc. (MPa)

Pv: Maximum operating pressure for vertical operation (MPa)

Wv: Allowable load mass for vertical operation (kg)

α : Load factor

$$\sum \alpha = \frac{\text{Load mass (W)}}{\text{Max. load mass (Wmax)}} + \frac{\text{Static moment (M)}}{\text{Allowable static moment (Mmax)}} + \frac{\text{Dynamic moment (Me)}}{\text{Allowable dynamic moment (Memax)}}$$

Operating Conditions

- W: Load mass (kg)
- V: Speed (mm/s)
- P: Operating pressure (MPa)
- Stroke (mm)
- Position of workpiece center of gravity (m)
- Mode of operation (Horizontal, Inclined, Vertical)

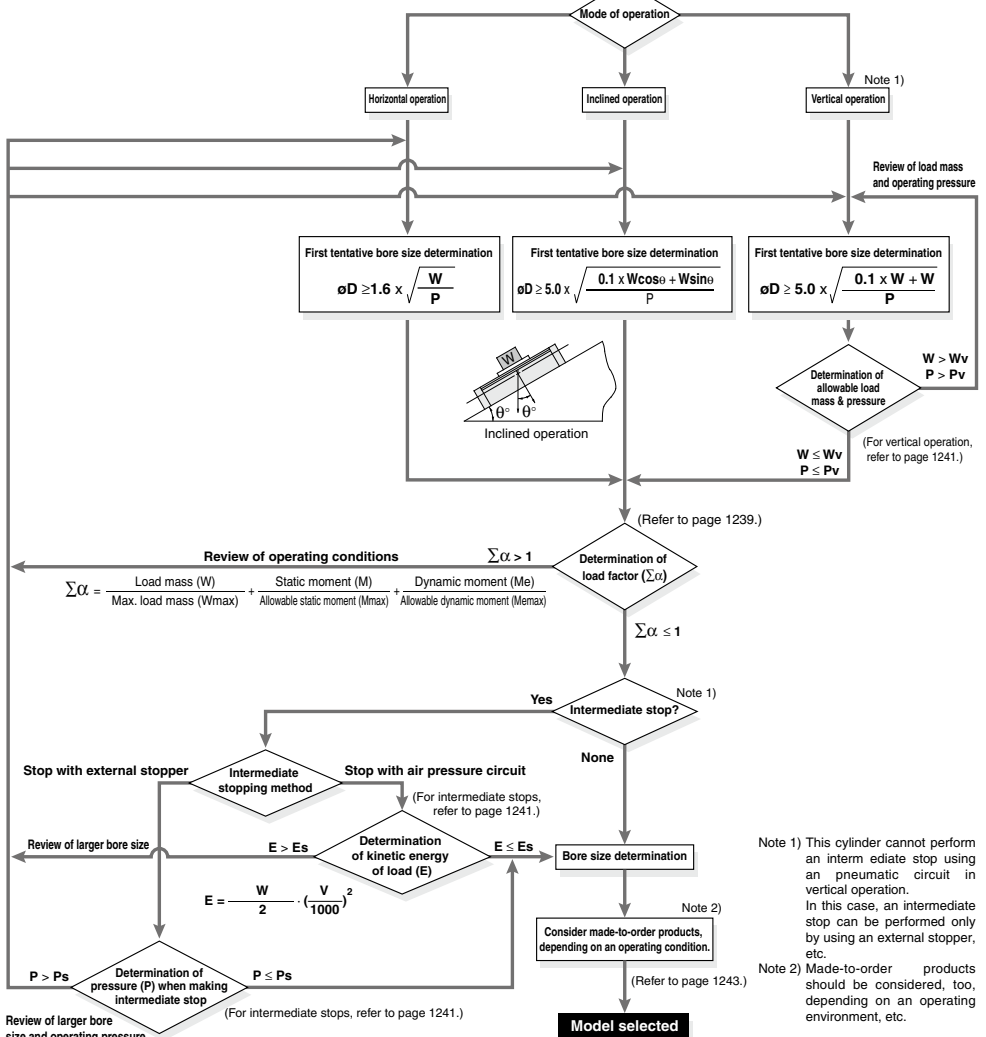

Review of larger bore size and operating pressure

(For intermediate stops, refer to page 1241.)

Caution on Design (1)

The maximum load mass and allowable moment will differ depending on the workpiece mounting method, cylinder mounting orientation and piston speed. A determination of usability is performed based on the operating limit values in the graphs with respect to operating conditions, but the total ($\Sigma \alpha n$) of the load factors (αn) for each mass and moment should not exceed 1.

$$\Sigma \alpha n = \frac{\text{Load mass (W)}}{\text{Maximum load mass (W max)}} + \frac{\text{Static moment (M)}}{\text{Allowable static moment (M max)}} + \frac{\text{Dynamic moment (Me)}}{\text{Allowable dynamic moment (Me max)}} \leq 1$$

Wmax, Mmax and Me max values are according to graph (1), (2) and (3) below.

Load Mass

Maximum Load Mass

Model	W _{max} (kg)
CY1H10	4.0
CY1H15	9.0
CY1H20	16.0
CY1H25	25.0
CY1HT25	25.0
CY1HT32	40.0

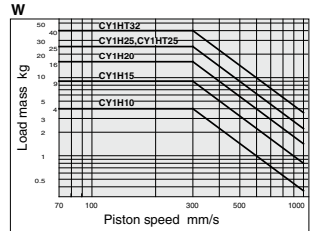
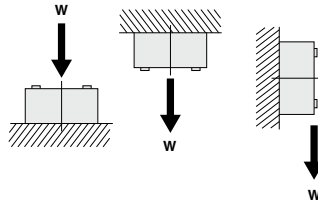

Graph (1)

Moment

Allowable Moment

(Static moment/Dynamic moment) (N·m)

Model	M1	M2	M3	Model	M1	M2	M3
CY1H10	1.5	2.5	1.5	CY1H25	28	26	28
CY1H15	10	16	10	CY1HT25	56	85	56
CY1H20	13	16	13	CY1HT32	64	96	64

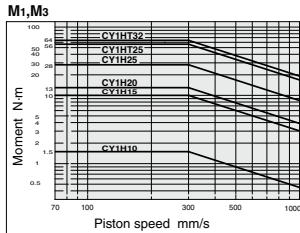
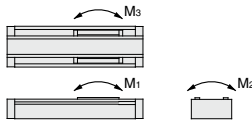

Graph (2)

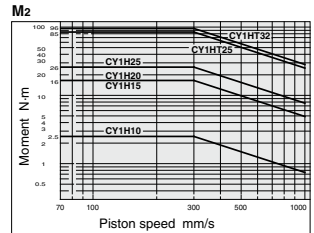

Graph (3)

Static Moment

Moment generated by the workpiece weight even when the cylinder is stopped

■ Pitch moment

$$M_1 = W \cdot L$$

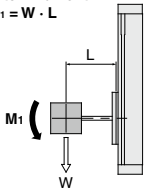

■ Roll moment

$$M_2 = W \cdot L$$

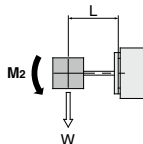

■ Yaw moment

$$M_3 = W \cdot (L - A)$$

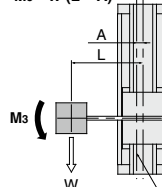

(mm)

Model	A
CY1H10	15
CY1H15	17.5
CY1H20	19.5
CY1H25	23.5
CY1HT25	0*
CY1HT32	0*

* Since there are 2 guides, the guides' central axis and the cylinder's central axis are the same.

Dynamic Moment

Moment generated by the load equivalent to impact at the stroke end

$$We = \delta \cdot W \cdot V$$

$$V = 1.4 Va$$

We: Load equivalent to impact [N]
 δ : Bumper coefficient
 With adjusting bolt (standard) = 4/100
 With shock absorber = 1/100
 W: Load mass [kg]
 V: Collision speed [mm/s]
 Va: Average speed [mm/s]

■ Pitch moment

$$Me_1 = 1/3 \cdot We \cdot L$$

* Average load coefficient

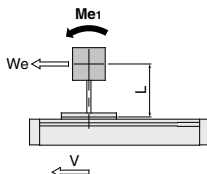

■ Yaw moment

$$Me_3 = 1/3 \cdot We \cdot (L - A)$$

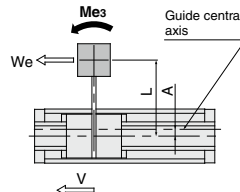

(mm)

Model	A
CY1H10	15
CY1H15	17.5
CY1H20	19.5
CY1H25	23.5
CY1HT25	0*
CY1HT32	0*

* Since there are 2 guides, the guides' central axis and the cylinder's central axis are the same.

CY1H Series

Selection Calculation

The selection calculation finds the load factors (α_n) of the items below, where the total ($\Sigma\alpha_n$) does not exceed 1.

$$\Sigma\alpha_n = \alpha_1 + \alpha_2 + \alpha_3 \leq 1$$

Item	Load factor α_n	Note
1. Max. load mass	$\alpha_1 = W/W_{max}$	Examine W . W_{max} is the max. load mass for Va .
2. Static moment	$\alpha_2 = M/M_{max}$	Examine M1 , M2 , M3 . M_{max} is the allowable moment for Va .
3. Dynamic moment	$\alpha_3 = Me/Me_{max}$	Examine Me1 , Me3 . Me_{max} is the allowable moment for V .

V : Collision speed Va : Average speed

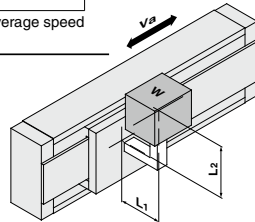

Calculation Example

Operating Conditions

Cylinder: CY1H15
 Cushion: Standard (Adjusting bolt)
 Mounting: Horizontal wall mounting
 Speed (average): $V_a = 300$ [mm/s]
 Load mass: $W = 1$ [kg] (excluding mass of arm section)
 $L_1 = 50$ [mm]
 $L_2 = 50$ [mm]

Item	Load factor α_n	Note
1 Maximum load mass 	$\alpha_1 = W/W_{max}$ $= 1/9$ $= 0.111$	Examine W . Find the value of W_{max} when Va = 300 mm/s from Graph (1).
2 Static moment 	$M_2 = W \cdot L_1$ $= 10 \cdot 0.05$ $= 0.5$ [N·m] $\alpha_2 = M_2/M_2 \text{ max}$ $= 0.5/16$ $= 0.031$	Examine M2 . Since M1 & M3 are not generated, investigation is unnecessary. Find the value M2 max when Va = 300 mm/s from Graph (3).
3 Dynamic moment 	From $V = 1.4 V_a$ $We = \delta \cdot W \cdot V$ $= 4/100 \cdot 10 \cdot 1.4 \cdot 300$ $= 168$ [N] $Me_3 = 1/3 \cdot We (L_2 - A)$ $= 1/3 \cdot 168 \cdot 0.032$ $= 1.8$ [N·m] $\alpha_3 = Me_3/Me_3 \text{ max}$ $= 1.8/7.2$ $= 0.250$	Examine Me3 . Find the load equivalent to impact We . Damper coefficient $\delta = 4/100$ (urethane damper) Find the value of Me3 max when V = 1.4 and Va = 420 mm/s from Graph (2).
	$Me_1 = 1/3 \cdot We \cdot L_1$ $= 1/3 \cdot 168 \cdot 0.05$ $= 2.8$ [N·m] $\alpha_4 = Me_1/Me_1 \text{ max}$ $= 2.8/7.2$ $= 0.389$	Examine Me1 . From above, We = 168 Find the value of Me3 max when V = 1.4 and Va = 420 mm/s from Graph (2).

$$\Sigma\alpha_n = \alpha_1 + \alpha_2 + \alpha_3 + \alpha_4$$

$$= 0.111 + 0.031 + 0.250 + 0.389$$

$$= 0.781$$

Can be used based on $\Sigma\alpha_n = 0.781 \leq 1$

Caution on Design (2)

Table Deflection (Note)

Table Displacement due to Pitch Moment Load

Displacement of Section A when force acts on Section F

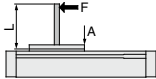

$$M1 = F \times L$$

CY1H10

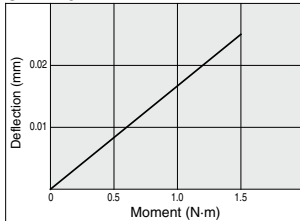

CY1H15/20/25

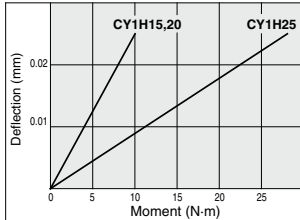

CY1HT25/32

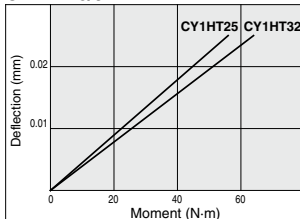
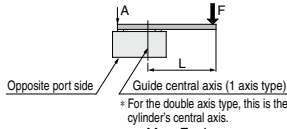

Table Displacement due to Roll Moment Load

Displacement of Section A when force acts on Section F



$$M2 = F \times L$$

CY1H10

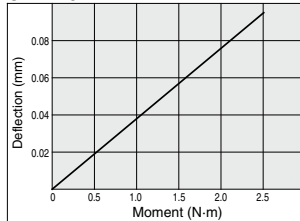

CY1H15/20/25

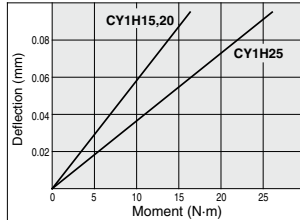

CY1HT25/32

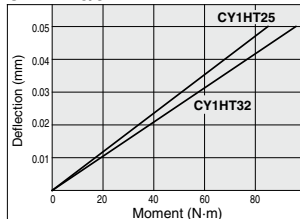
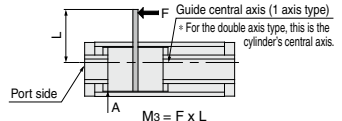

Table Displacement due to Yaw Moment Load

Displacement of Section A when force acts on Section F



$$M3 = F \times L$$

CY1H10

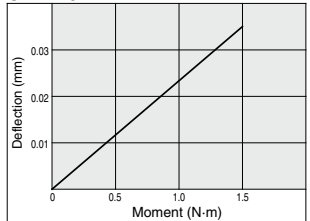

CY1H15/20/25

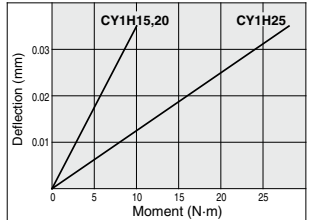

CY1HT25/32

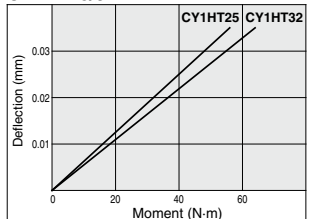

Note) Indicates the displacement (rigidity) on the slide table from the position where the reaction force is generated when the torque is applied to the slide table. (Reference values) Please contact SMC for the accuracy.

Vertical Operation

When using in vertical operation, prevention of workpiece dropping due to breaking of the magnetic coupling should be considered. The allowable load mass and maximum operating pressure should be as shown in the table below. When the cylinder is mounted vertically or sidelong, sliders may move downwards due to the self-weight or workpiece mass. If an accurate stopping position is required at the stroke end or the middle-stroke, use an external stopper to secure accurate positioning.

Model	Allowable load mass (Wv) (kg)	Maximum operating pressure Pv (MPa)
CY1H10	2.7	0.55
CY1H15	7.0	0.65
CY1H20	11.0	0.65
CY1H25	18.5	0.65
CY1HT25	18.5	0.65
CY1HT32	30.0	0.65

Intermediate Stop

(1) Intermediate Stopping of Load with External Stopper, etc.

When stopping a load in mid-stroke using an external stopper, etc., operate within the operating pressure limits shown in the table below. The magnetic coupling will break if operated at a pressure exceeding these limits.

Model	Operating pressure limit for intermediate stop Ps (MPa)
CY1H10	0.55
CY1H15	0.65
CY1H20	0.65
CY1H25	0.65
CY1HT25	0.65
CY1HT32	0.65

(2) Intermediate Stopping of Load with Air Pressure Circuit

When stopping a load using an air pressure circuit, operate at or below the kinetic energy shown in the table below. The magnetic coupling will break if the allowable value is exceeded.

Model	Allowable kinetic energy for intermediate stop Es (J)
CY1H10	0.03
CY1H15	0.13
CY1H20	0.24
CY1H25	0.45
CY1HT25	0.45
CY1HT32	0.88

Magnetically Coupled Rodless Cylinder Linear Guide Type

CY1H Series

Single axis: $\varnothing 10, \varnothing 15, \varnothing 20, \varnothing 25$ /Double axis: $\varnothing 25, \varnothing 32$



How to Order

CY1H **25** - **300** - **Y7BW** -

Linear guide type **Guide** **Made to Order**
Refer to page 1243 for details.

Bore size (mm)	10	15	20	25	32
Symbol	10	15	20	25	32
Nil	1 axis	●	●	●	—
T	2 axis	—	—	●	●

Number of auto switches

Nil	2 pcs.
S	1 pc.
n	"n" pcs.

Auto switch

Nil	Without auto switch (Built-in magnet)
-----	---------------------------------------

* For the applicable auto switch model, refer to the table below.

Adjustment type

Nil	With adjusting bolt
B	With shock absorbers (2 pcs.)
BS	With shock absorber (1 pc. on port side)

* The adjusting bolt is installed even when B or BS is selected. (Except $\varnothing 10$)

Bore size

10	10 mm
15	15 mm
20	20 mm
25	25 mm
32	32 mm

Port thread type

Symbol	Type	Bore size
Nil	M thread	$\varnothing 10, \varnothing 15$
TN	Rc	$\varnothing 20, \varnothing 25, \varnothing 32$
TF	NPT	
	G	

Standard stroke (mm)
Refer to "Standard Stroke" on page 1243.

Shock Absorbers

Model	Type	Bore size (mm)				
		10	15	20	25	32
CY1H	Standard (shock absorber RB series)	RB0805	RB0806	RB1006	RB1411	—
	Shock absorber soft type RJ series type (-XB22)	RJ0806H		RJ1007H	RJ1412H	—
CY1HT	Standard (shock absorber RB series)	—	—	—	RB1411	RB2015
	Shock absorber soft type RJ series type (-XB22)	—	—	—	RJ1412H	—

* The shock absorber service life is different from that of the CY1H cylinder.

Refer to "Specific Product Precautions" for each shock absorber for the replacement period.

* The shock absorber soft type RJ series type (-XB22) is a made to order specification. For details, refer to page 1468.

Applicable Auto Switches/Refer to pages 1289 to 1383 for further information on auto switches.

Type	Special function	Electrical entry	Indicator light	Wiring (Output)	Load voltage		Auto switch model		Lead wire length (m)*			Pre-wired connector	Applicable load		
					DC	AC	Perpendicular	In-line	0.5 (Nil)	3 (L)	5 (Z)		IC circuit	Relay, PLC	
															Y69A
Solid state auto switch	—	Grommet	Yes	3-wire (NPN)	24 V	5 V, 12 V	—	Y69A	Y59A	●	●	○	○	IC circuit	Relay, PLC
				3-wire (PNP)				Y7P	Y7P	●	●	○	○	—	
				2-wire				Y69B	Y59B	●	●	○	○	—	
	Diagnostic indication (2-color indicator)			3-wire (NPN)	Y7NWV	Y7NW	●	●	○	○	IC circuit				
				3-wire (PNP)	Y7PWW	Y7PW	●	●	○	○	—				
				2-wire	Y7BWW	Y7BW	●	●	○	○	—				
Water resistant (2-color indicator)	—	Grommet	Yes	2-wire	12 V	—	—	Y7BA**	—	●	○	○	—		
				3-wire (NPN equivalent)	5 V	—	—	Z76	●	●	—	—	IC circuit	—	
					24 V	12 V	100 V	—	Z73	●	●	—	—	Relay, PLC	
5 V, 12 V	100 V or less	—	Z80	●	●	—	—	—	IC circuit	—					

** Water resistant type auto switches can be mounted on the above models, but in such case SMC cannot guarantee water resistance.

Consult with SMC regarding water resistant types with the above model numbers.

* Lead wire length symbols: 0.5 m..... Nil (Example) Y7BW * Solid state auto switches marked with "○" are produced upon receipt of order.
3 m..... L (Example) Y7BWL
5 m..... Z (Example) Y7BWZ

• For details about auto switches with pre-wired connector, refer to pages 1358 and 1359.

• Normally closed (NC = b contact) solid state auto switches (D-Y7G/Y7H types) are also available. Refer to page 1310 for details.

* Auto switches are shipped together, (but not assembled).

Symbol

Rubber bumper
(Magnet type)



Made to Order: Individual Specifications
(For details, refer to pages 1252.)

Symbol	Specifications
-X168	Helical insert thread specifications

Made to Order Specifications

[Click here for details](#)

Symbol	Specifications
-XB10	Intermediate stroke (Using exclusive bolt)
-XB11	Long stroke
-XB22	Shock absorber soft type RJ series type

Theoretical Output

Bore size (mm)	Piston area (mm ²)	Operating pressure (MPa)					
		0.2	0.3	0.4	0.5	0.6	0.7
10	78	15	23	31	39	46	54
15	176	35	52	70	88	105	123
20	314	62	94	125	157	188	219
25	490	98	147	196	245	294	343
32	804	161	241	322	402	483	563

Note) Theoretical output (N) = Pressure (MPa) x Piston area (mm²)

Amount of Adjustment by Adjusting Bolt

Stroke adjustment on one side of 15 mm (CY1H10/15/20) or 30 mm (CY1H25, CY1HT25, CY1HT32) can be performed with the adjustment bolt, but when the amount of adjustment exceeds 3 mm, the magnetic coupling may be broken depending on the operating conditions. Therefore, operation should conform to the intermediate stop conditions on page 1241.

Do not adjust strokes by moving the stopper, as this can cause cylinder damage.

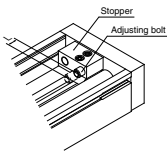

Model	Stroke adjustment range L (mm)
CY1H10, CY1H15, CY1H20	0 to 15
CY1H25, CY1HT25, CY1HT32	0 to 30

Specifications

Bore size (mm)	10	15	20	25	32
Fluid	Air				
Action	Double acting				
Maximum operating pressure	0.7 MPa				
Minimum operating pressure	0.2 MPa				
Proof pressure	1.05 MPa				
Ambient and fluid temperature	-10 to 60°C (No freezing)				
Piston speed	70 to 500 mm/s				
Cushion (External stopper)	Urethane bumpers on both ends (Standard), Shock absorber (Option)				
Lubrication	Not required (Non-lube)				
Stroke length tolerance	0 to 1.8 mm				
Holding force (N)	53.9	137	231	363	588
Piping	Centralized piping type				
Piping port size	M5 x 0.8		Rc 1/8		

Standard Stroke

Bore size (mm)	Number of axes	Standard stroke (mm) Note)	Maximum available stroke (mm)
10	1 axis	100, 200, 300	500
15		100, 200, 300, 400, 500	750
20		100, 200, 300, 400, 500, 600	1000
25		100, 200, 300, 400, 500, 600, 800	1200
25	2 axis	100, 200, 300, 400, 500, 600, 800, 1000	
32		1500	

Note) Strokes are manufacturable in 1 mm increments up to the maximum strokes. Suffix "XB10" to the end of the part number for intermediate strokes excluding standard strokes and "XB11" for strokes exceeding standard strokes up to the manufacturable maximum strokes.

Weight

Model	Standard stroke (mm)								(kg)
	100	200	300	400	500	600	800	1000	
CY1H10	1.0	1.3	1.6	—	—	—	—	—	—
CY1H15	2.2	2.7	3.2	3.6	4.1	—	—	—	—
CY1H20	3.0	3.5	4.0	4.4	4.9	5.4	—	—	—
CY1H25	4.6	5.3	6.0	6.6	7.3	8.0	9.4	—	—
CY1HT25	5.1	6.2	7.3	8.3	9.4	10.4	12.5	14.6	—
CY1HT32	8.4	9.6	10.7	11.9	13.0	14.2	16.5	18.8	—

Shock Absorber Specifications

Refer to the RB series in the [Web Catalog](#) for the details on shock absorbers.

Applicable cylinder size (mm)	10	15	20	25	32
Shock absorber model	RB0805	RB0806	RB1006	RB1411	RB2015
Maximum energy absorption (J)	0.98	2.94	3.92	14.7	58.8
Stroke absorption (mm)	5	6	6	11	15
Collision speed (m/s) *	0.05 to 5				
Max. operating frequency (cycle/min)	80		70		45
Spring force (N)	Extended		1.96		4.22
	Retracted		3.83		22
Weight (g)	15		25		65

* It denotes the values at the maximum energy absorption per one cycle. Therefore, the operating frequency can be increased according to the energy absorption.

The shock absorber service life is different from that of the CY1H cylinder. Refer to the Specific Product Precautions for the replacement period.

CY1H Series

Construction ^{Note)}

Single axis type / CY1H

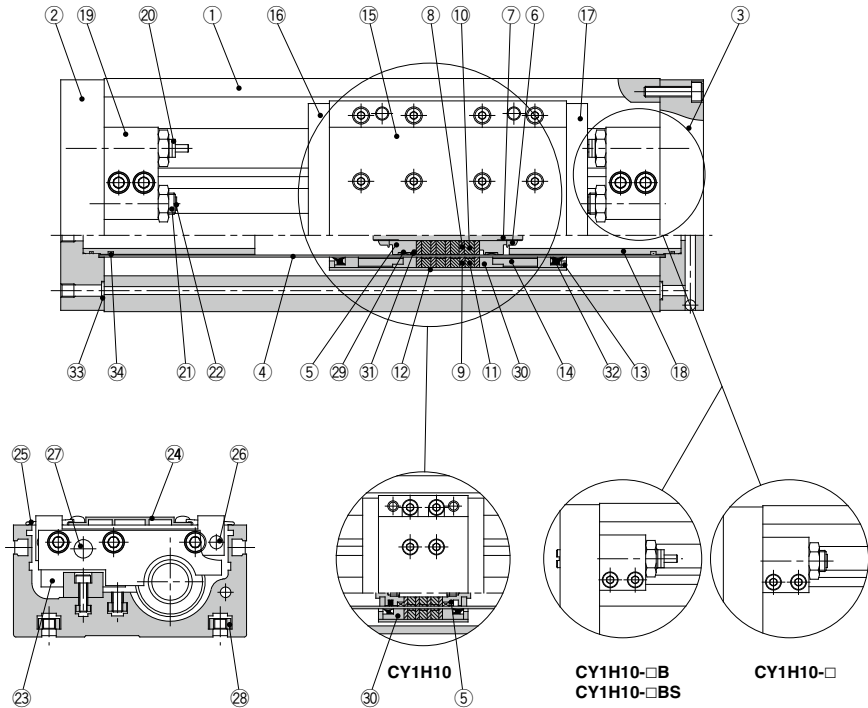

Component Parts

No.	Description	Material	Note
1	Body	Aluminum alloy	Anodized
2	Plate A	Aluminum alloy	Anodized
3	Plate B	Aluminum alloy	Anodized
4	Cylinder tube	Stainless steel	
5	Piston	Aluminum alloy	Chromated
6	Piston nut	Carbon steel	Zinc chromated (Except CY1H10/15)
7	Shaft	Stainless steel	
8	Piston side yoke	Rolled steel plate	Zinc chromated
9	External slider side yoke	Rolled steel plate	Zinc chromated
10	Magnet A	—	
11	Magnet B	—	
12	External slider tube	Aluminum alloy	
13	Spacer	Rolled steel plate	Nickel plated
14	Space ring	Aluminum alloy	Chromated (Except CY1H10)
15	Slide table	Aluminum alloy	Anodized
16	Side plate A	Aluminum alloy	Anodized
17	Side plate B	Aluminum alloy	Anodized
18	Internal stopper	Aluminum alloy	Anodized
19	Stopper	Aluminum alloy	Anodized
20	Shock absorber	—	RB series
21	Adjusting bolt	Chrome molybdenum steel	Nickel plated
22	Adjusting bumper	Urethane rubber	
23	Linear guide	—	
24	Top cover	Aluminum alloy	Anodized
25	Dust cover	Special resin	
26	Magnet (For auto switch)	—	

No.	Description	Material	Note
27	Parallel pin	Carbon steel	Nickel plated
28	Square nut for body mounting	Carbon steel	Nickel plated
29*	Wear ring A	Special resin	
30*	Wear ring B	Special resin	
31*	Piston seal	NBR	
32*	Scraper	NBR	
33*	O-ring	NBR	
34*	O-ring	NBR	

Note) 4 square nuts for body mounting are included regardless of strokes.

Replacement Parts: Seal Kit

Bore size (mm)	Kit no.	Contents
10	CY1H10-PS	Set of the above nos. 30, 31, 32, 33, 34
15	CY1H15-PS	Set of the above nos. 29, 30, 31, 32, 33, 34
20	CY1H20-PS	
25	CY1H25-PS	

Note 1) Seal kit includes 29 to 34. Order the seal kit, based on each bore size.

Note 2) For replacement of the ϕ 10 wear ring A, contact SMC or your nearest sales representative.

* Seal kit includes a grease pack (ϕ 10: 5 and 10 g, ϕ 15 to ϕ 25: 10 g).

Order with the following part number when only the grease pack is needed.

Grease pack part no. for ϕ 10: GR-F-005 (5 g) for external sliding parts,

GR-S-010 (10 g) for tube interior

Grease pack part no. for ϕ 15 to ϕ 25: GR-S-010 (10 g)

Construction

Double axis type / CY1HT

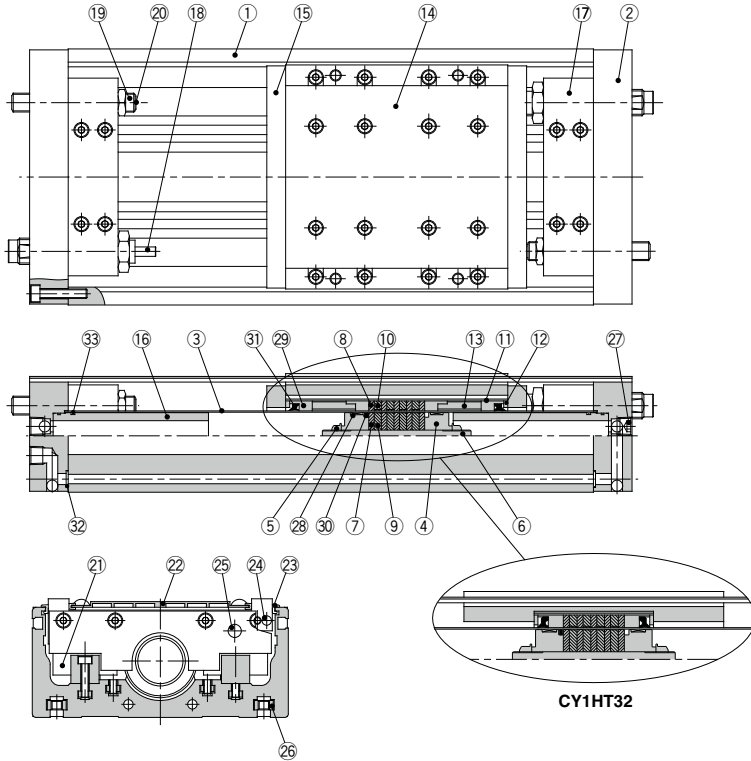

Component Parts

No.	Description	Material	Material
1	Body	Aluminum alloy	Anodized
2	Plate	Aluminum alloy	Anodized
3	Cylinder tube	Stainless steel	
4	Piston	Aluminum alloy	Chromated
5	Piston nut	Carbon steel	Zinc chromated
6	Shaft	Stainless steel	
7	Piston side yoke	Rolled steel plate	Zinc chromated
8	External slider side yoke	Rolled steel plate	Zinc chromated
9	Magnet A	—	
10	Magnet B	—	
11	External slider tube	Aluminum alloy	
12	Spacer	Rolled steel plate	Nickel plated
13	Space ring	Aluminum alloy	Chromated (Except CY1HT32)
14	Slide table	Aluminum alloy	Anodized
15	Side plate	Aluminum alloy	Anodized (Except CY1HT32)
16	Internal stopper	Aluminum alloy	Anodized
17	Stopper	Aluminum alloy	Anodized
18	Shock absorber	—	RB series
19	Adjusting bolt	Chrome molybdenum steel	Nickel plated
20	Adjusting bumper	Urethane rubber	
21	Linear guide	—	
22	Top cover	Aluminum alloy	Anodized
23	Dust cover	Special resin	
24	Magnet (For auto switch)	—	
25	Parallel pin	Stainless steel	

No.	Description	Material	Material
26	Square nut for body mounting	Carbon steel	Nickel plated
27	Hexagon socket head taper plug	Carbon steel	Nickel plated
28*	Wear ring A	Special resin	
29*	Wear ring B	Special resin	
30*	Piston seal	NBR	
31*	Scraper	NBR	
32*	O-ring	NBR	
33*	O-ring	NBR	

Note) 4 square nuts for body mounting are included regardless of strokes.

Replacement Parts: Seal Kit

Bore size (mm)	Kit no.	Contents
25	CY1HT25-PS	Set of the above nos.
32	CY1HT32-PS	28, 29, 30, 31, 32, 33

* Seal kit includes 28 to 33. Order the seal kit, based on each bore size.
 * Seal kit includes a grease pack (10 g).
 Order with the following part number when only the grease pack is needed.
Grease pack part no.: GR-S-010 (10 g)

CY1H Series

Dimensions

Single axis type / $\varnothing 10$

CY1H10

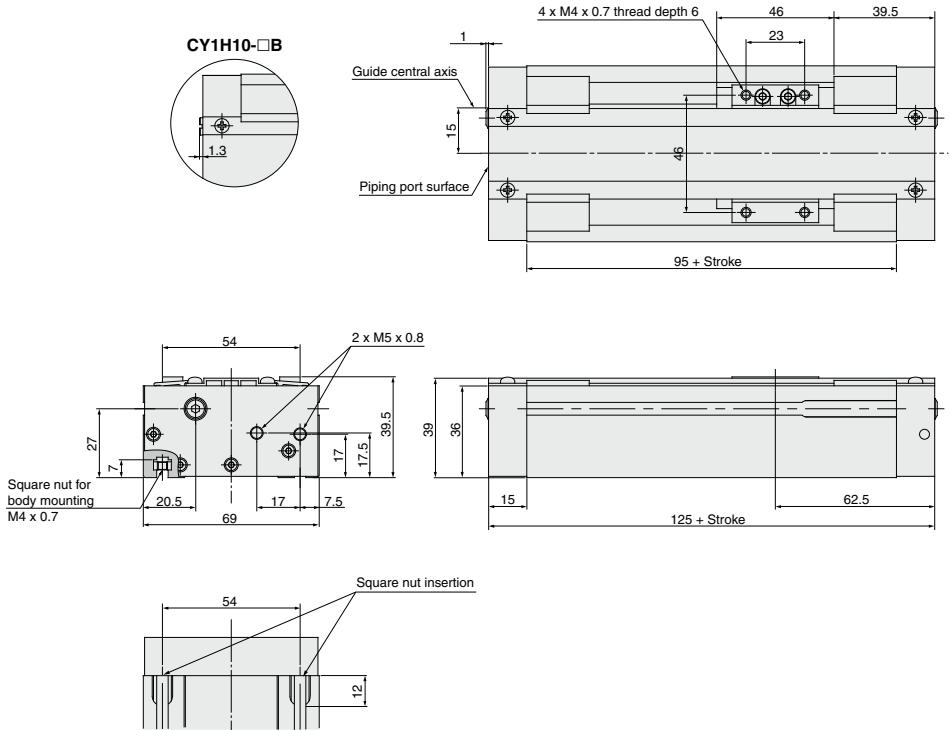

Dimensions

Single axis type / $\varnothing 15, \varnothing 20, \varnothing 25$

CY1H15/20/25

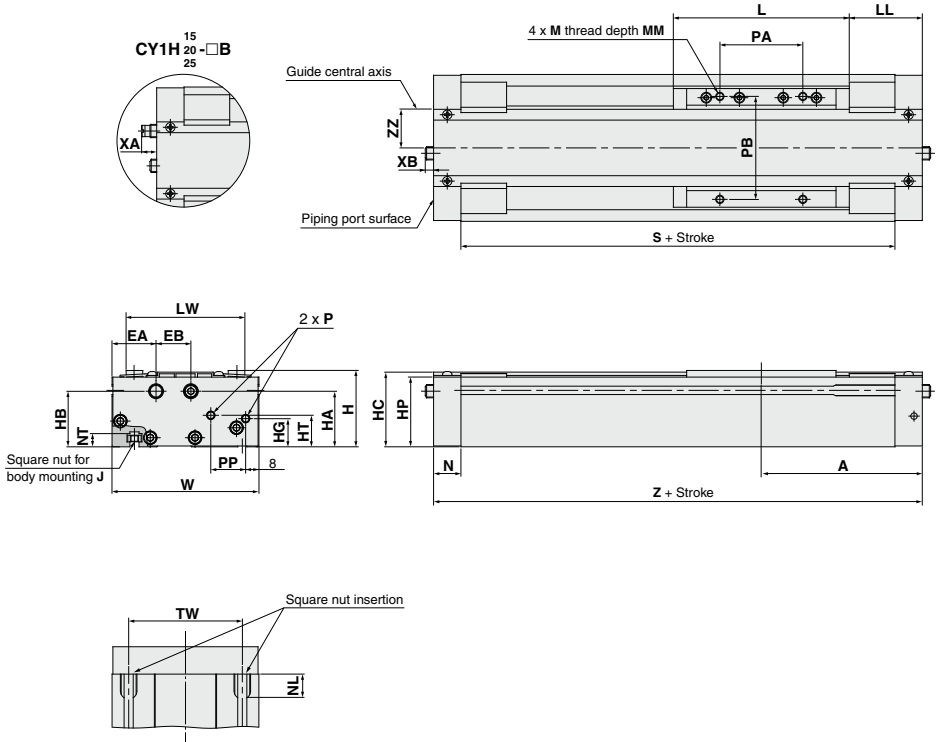

(mm)

Model	A	EA	EB	H	HA	HB	HC	HG	HP	HT	J	L	LL	LW	M	MM	N	NL	NT
CY1H15	97	26.5	21	46	33.5	33.5	45	17	42	19	M5 x 0.8	106	44	71.5	M5 x 0.8	8	16.5	15	8
CY1H20	102.5	26.5	22	54	42.5	41.5	53	16	50	23.5	M5 x 0.8	108	48.5	75.5	M5 x 0.8	8	18	15	8
CY1H25	125	29	24	63	46	46	61.5	25	58.5	28	M6 x 1.0	138	56	86	M6 x 1.0	10	20.5	18	9

Model	P	PA	PB	PP	S	TW	W	XA	XB	Z	ZZ
CY1H15	M5 x 0.8	50	62	21	161	65	88.5	—	—	194	17.5
CY1H20	Rc1/8	50	65	23	169	70	92.5	—	—	205	19.5
CY1H25	Rc1/8	65	75	27	209	75	103	11.3	9.5	250	23.5

CY1H Series

Dimensions

Double axis type: / $\varnothing 25$, $\varnothing 32$

CY1HT25/32

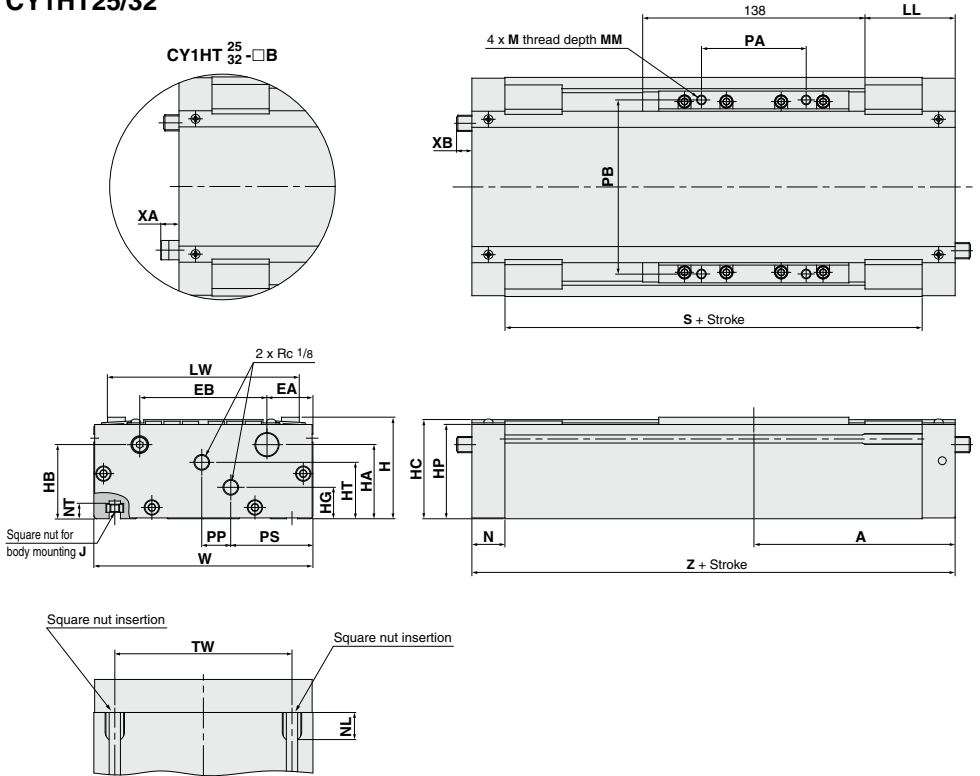

(mm)

Model	A	EA	EB	H	HA	HB	HC	HG	HP	HT	J	LL	LW	M	MM	N	NL	NT	PA
CY1HT25	125	28.5	79	63	46	46	61.5	19.5	58.5	35	M6 x 1.0	56	119	M6 x 1.0	10	20.5	18	9	65
CY1HT32	132.5	30	90	75	52.5	57.5	72.5	25	69.5	43	M8 x 1.25	63.5	130	M8 x 1.25	12	23	22.5	12	66

Model	PB	PP	PS	S	TW	W	XA	XB	Z
CY1HT25	108	18	51	209	110	136	11.3	9.5	250
CY1HT32	115	14	61	219	124	150	9.7	2	265

CY1H Series Auto Switch Mounting

Proper Auto Switch Mounting Position (Detection at stroke end)

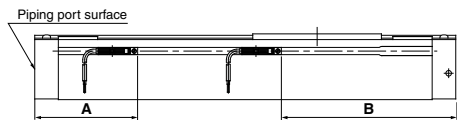

Cylinder model	Applicable auto switch	
	D-Z7□/ Z80/ Y5□/ Y6□/ Y7□	
	A	B
CY1H10	65.5	59.5
CY1H15	72	122
CY1H20	77.5	127.5
CY1H25	86	164
CY1HT25	86	164
CY1HT32	82	183

* 50 mm is the minimum stroke available with 2 auto switches mounted. Please contact SMC in the case of a stroke less than this.

Note) Adjust the auto switch after confirming the operating conditions in the actual setting.

Mounting of Auto Switch

To install the auto switch, insert the auto switch into the installation groove of the cylinder from the direction shown in the drawing on the right, and tighten the auto switch mounting screws attached to the auto switch with a watchmaker's screwdriver after setting the mounting position.

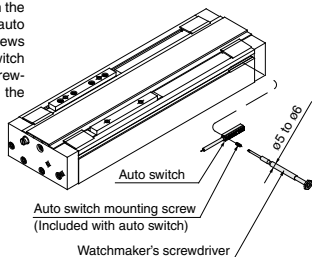

Note) Use a watchmaker's screwdriver with a grip diameter of 5 to 6 mm to tighten the auto switch mounting screws (attached to the auto switch).

The tightening torque should be 0.05 to 0.1 N•m.

Auto Switch Lead Wire Containment Groove

On models CY1H20 and CY1H25 a groove is provided on the side of the body (one side only) to contain auto switch lead wires. This should be used for management of wiring.

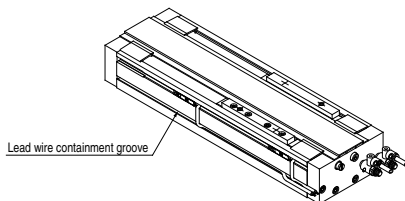

Operating Range

Cylinder model	Auto switch model	Bore size (mm)				
		10	15	20	25	32
CY1H	D-Z7□/ Z80	8	6	6	6	—
	D-Y5□/ Y6□/ Y7□	6	5	5	5	—
CY1HT	D-Z7□/ Z80	—	—	—	6	9
	D-Y5□/ Y6□/ Y7□	—	—	—	5	6

* Some auto switches cannot be mounted.

* Since this is a guideline including hysteresis, not meant to be guaranteed. (Assuming approximately $\pm 30\%$ dispersion)

There may be the case it will vary substantially depending on an ambient environment.



CY1H Series Specific Product Precautions 1

Be sure to read this before handling the products. Refer to page 8 for safety instructions and pages 9 to 18 for actuator and auto switch precautions.

Operation

⚠ Warning

1. Be aware of the space between the plates and the slide block.

Take sufficient care to avoid getting your hands or fingers caught when the cylinder is operated.

2. Do not apply a load to a cylinder which is greater than the allowable value stated in the "Model Selection" pages.

This may cause malfunctions.

3. When the cylinder is used in a place where water or cutting oil may splash or the lubrication condition on the cylinder sliding parts would be deteriorated, please consult with SMC.

4. When applying grease to the cylinder, use the grease that has already been applied to the product. Contact SMC for available grease packs.

⚠ Caution

1. The unit can be used with a direct load within the allowable range, but when connecting to a load which has an external guide mechanism, careful alignment is necessary.

Since variation of the shaft center increases as the stroke becomes longer, a connection method should be devised which allows for this displacement.

2. Since the guide is adjusted at the time of shipment, unintentional movement of the adjustment setting should be avoided.

3. This unit can be operated without lubrication. If lubrication is performed, use turbine oil Class 1 (with no additives), ISO VG32. (Machine oil and spindle oil cannot be used.)

4. Do not use the cylinder in an environment where the cylinder is exposed to moisture, adhesive foreign matter, dust or liquid such as water or cutting fluid.
If the cylinder is used in an environment where the lubrication of the cylinders sliding parts is compromised, please consult SMC.

5. Do not operate with the magnetic coupling out of position.

In case the magnetic coupling is out of position, push the external slider back into the correct position by hand at the end of the stroke (or correct the piston slider with air pressure).

6. Do not disassemble the magnetic components (piston slider, external slider).

This can cause a loss of holding power and malfunction.

Mounting

⚠ Caution

1. The interior is protected to a certain extent by the top cover, however, when performing maintenance, etc., take care not to cause scratches or other damage to the cylinder tube, slide table or linear guide by striking them or placing objects on them.

Cylinder bores are manufactured to precise tolerances, so that even a slight deformation may cause faulty operation.

2. Because the slider is supported by precision bearings, take care not to apply strong impacts or excessive moments to the table when loading a workpiece.

3. Mounting of the cylinder body

The body is mounted using the square nuts, which are included, in the two T-slots on the bottom of the body. Refer to the table below for mounting bolt dimensions and tightening torque.

Model		CY1H10	CY1H15	CY1H20	CY1H25	CY1HT25	CY1HT32
Bolt dimensions	Thread size	M4 x 0.7	M5 x 0.8		M6 x 1.0		M8 x 1.25
	Dimension t	L-7	L-8	L-8	L-9		L-12
Tightening torque	N · m	1.37	2.65		4.4		13.2

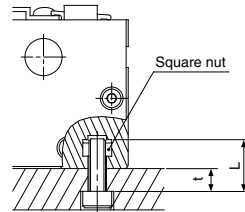

Service Life and Replacement Period of Shock Absorber

⚠ Caution

1. Allowable operating cycle under the specifications set in this catalog is shown below.

- 1.2 million times RB08□□
- 2 million times RB10□□ to RB2725

Note) Specified service life (suitable replacement period) is the value at room temperature (20 to 25°C).

The period may vary depending on the temperature and other conditions. In some cases the absorber may need to be replaced before the allowable operating cycle above.



CY1H Series Specific Product Precautions 2

Be sure to read this before handling the products. Refer to page 8 for safety instructions and pages 9 to 18 for actuator and auto switch precautions.

Stroke Adjustment Method

Loosen the round head Phillips Screws, and remove the top cover and dust covers (4 pcs.).

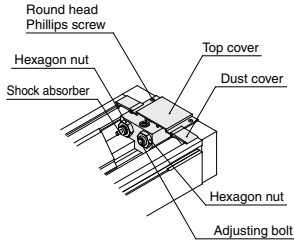

Loosen the hexagon nut, adjust the stroke with a hexagon wrench from the plate side, and secure by retightening the hexagon nut. When there is a shock absorber, loosen the hexagon nut, adjust the stroke, and then retighten the hexagon nut.

Adjustment should be performed to make effective use of the shock absorber's absorption capacity, with its position relative to the adjustment bolt as shown in the figure to the right.

⚠ Caution

1. If the effective stroke of the shock absorber is shortened by the stroke adjustment, its absorption capacity will be drastically reduced. Therefore, the adjusting bolt should be secured at a position where it projects about 0.5 mm farther than the shock absorber.

Lock Nut Tightening Torque

N·m

Model	For shock absorber	For adjusting bolt
CY1H10	1.67	1.67
CY1H15		
CY1H20	3.14	3.14
CY1H25	10.8	
CY1HT25		
CY1HT32	23.5	

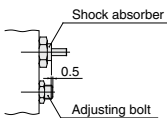

After completing the above adjustment, replace the top cover and dust covers back into place.

The round head Phillips screws for securing the top cover should be tightened with a torque of 0.58 N·m.

CY1L/H Series

Made to Order: Individual Specifications

Please contact SMC for detailed dimensions, specifications and lead times.



Applicable Series

No.	Symbol	Specifications/Description	Slider type	
			Ball bushing type CY1L	High precision guide type CY1H
1	-X116	Hydro specifications	●(ø25 to ø40)	—
2	-X168	Helical insert thread specifications	●(ø20 to ø40)	●(ø20 to ø32)
3	-X322	Outside of cylinder tube with hard chrome plated	●(ø15 to ø40)	—
4	-X431	Auto switch rails on both side faces (With 2 pcs.)	●(ø6 to ø40)	—

1 Hydro Specifications **-X116**

This type is applicable for precision constant speed feed, intermediate stop and skip feed.

[Slider type]

CY1L - - - **X116**

Hydro specifications

Specifications

Type	Slider type
Bore size	Slider type CY1L25 to 40
Fluid	Turbine oil
Piston speed	15 to 300 mm/s

Note) Piping is from each plate on both sides.

Dimensions

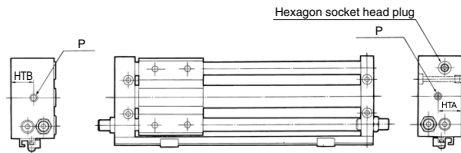

(mm)				
Model	HTA	HTB	P	Throttle dia.
CY1L25	20	23	Rc 1/8	8.2
CY1L32	24	26.5	Rc 1/8	8.2
CY1L40	25	30.5	Rc 1/4	11

* Dimensions other than the above are the same as the standard type.

2 Helical Insert Thread Specifications **-X168**

CY1L - - **X168**

Helical insert thread specifications

Helical insert thread is used for standard mounting thread.

Specifications

Applicable Series	CY1L/CY1H
Bore size	CY1L : ø20 to ø40 CY1H : ø20 to ø32

3 Outside of Cylinder Tube with Hard Chrome Plated **-X322**

CY1L - - **X322**

Outside of cylinder tube with hard chrome plated

The cylinder tube outer circumference is plated with hard chrome, which further reduces bearing abrasion.

Note) The slider type (slide block) is provided with a greasing port.

Specifications

Applicable Series	Bore size (mm)
CY1L	ø15 to ø40

Construction/Dimensions

CY1L (Slider type)

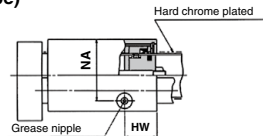

Bore size (mm)	CY1L (mm)	
	NA	HW
15	33.0	37.5
20	38.0	43.0
25	43.0	43.0
32	50.0	50.0
40	61.0	68.0

Symbol

4 Auto Switch Rails on Both Side Faces (With 2 pcs.)

-X431

CY1L

Bore size

Magnetic holding force

 —

Stroke

 — X431

Auto switch rails on both side faces (With 2 pcs.)

This auto switch is effective in the case of short strokes.

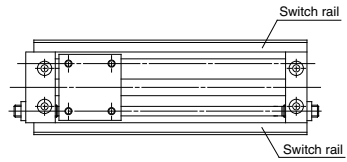

Specifications

Applicable Series	CY1L
Bore size	ø6 to ø40

Bore size (mm)	Applicable stroke (mm)
6	20 to
10	25 to
15	
20	
25	
32	35 to
40	