

Air Cylinder

CG3 Series

ø20, ø25, ø32, ø40, ø50, ø63, ø80, ø100

Compact with a new construction!
New release with full functions

Minimized with shorter total length!

Space saving; contributes to downsizing of equipment.

RoHS

Up to

24%
lighter

Up to
51 mm shorter

129mm

37 mm shorter

CG3

Female thread

CG3

Male thread

Current model **CG1**

Male thread

CG3BN40-50 □ stroke



CJ1

CJP

CJ2

JCM

CM2

CM3

CG1

CG3

JMB

MB

MB1

CA2

CS1

CS2

D-□

-X□

Technical
Data

Air Cylinder Short Type

Standard: Double Acting, Single Rod

CG3 Series



ø20, ø25, ø32, ø40, ø50, ø63, ø80, ø100

How to Order



With auto switch

CG3 L N 25 - 100 - [] - []

CDG3 L N 25 - 100 - [] - M9BW - [] - C - []

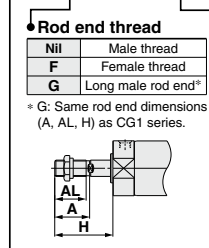
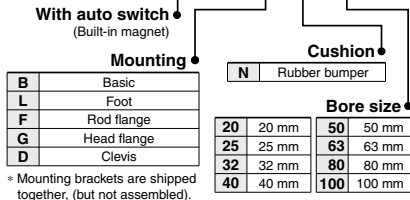

Made to Order
 For details, refer to page 366.
 • Auto switch mounting bracket (Note)
 Note) This symbol is indicated when the D-A9□ or M9□ type auto switch is specified. This mounting bracket does not apply to other auto switches (D-C7□ and H7□, etc.) (Nil)
 • Number of auto switches

Nil	2 pcs.
S	1 pc.
n	"n" pcs.

 • Auto switch

Nil	Without auto switch
-----	---------------------

 * For applicable auto switches, refer to the below table.

Built-in Magnet Cylinder Model

If a built-in magnet cylinder without an auto switch is required, there is no need to enter the symbol for the auto switch.
 (Example) CDG3FN32-100

Applicable Auto Switches

Refer to pages 1575 to 1701 in Best Pneumatics No. 2 for further information on auto switches.

Type	Special function	Electrical entry	Indicator light	Wiring (Output)	Load voltage		Auto switch model			Lead wire length (m)					Pre-wired connector	Applicable load																				
					DC	AC	Applicable bore size			Lead wire length (m)																										
							ø20 to ø63	ø80, ø100	Perpendicular	In-line	In-line	0.5 (Nil)	1 (M)	3 (L)			5 (Z)	None (N)																		
Solid state auto switch	—	Grommet	Yes	3-wire (NPN)	5 V, 12 V	—	M9NV	M9N	G59	●	●	○	○	○	○	IC circuit	Relay, PLC																			
				3-wire (PNP)						●	●	○	○	○	○																					
		Connector		2-wire						12 V	—	—	—	—	—			—	—	—	—	—	—													
				—						—	—	—	—	—	—			—	—	—	—	—	—													
		Diagnostic indication (2-color indicator)		Grommet						Yes	3-wire (NPN)	24 V	5 V, 12 V	M9NVW	M9NW			G59W	●	●	○	○	○	○	IC circuit											
											3-wire (PNP)								●	●	○	○	○	○												
	Grommet		2-wire	12 V	—	—	—	—	—		—					—			—	—	—															
			—	—	—	—	—	—	—		—					—			—	—	—															
	Water resistant (2-color indicator)		Grommet	Yes	3-wire (NPN)	5 V, 12 V	—	M9NAV*1	M9NA*1		—					○			○	○	○	○	○	IC circuit												
					3-wire (PNP)											○			○	○	○	○	○													
	Connector	2-wire	12 V		—					—		—	—	—	—	—		—	—	—																
		—	—		—					—		—	—	—	—	—		—	—	—																
With diagnostic output (2-color indicator)	Grommet	Yes	4-wire (NPN)		5 V, 12 V					—		M9BAV*1	M9BA*1	—	○	○	○	○	○	○	IC circuit															
			—												—	—	—	—	—	—		—	—		—											
Reed auto switch	Grommet		Yes	No		3-wire (NPN equivalent)	—	—	A96V		A96				—	●	●	○	○	○		IC circuit														
						—										—	—	—	—	—			—	—	—											
Connector	Grommet					Yes										No	2-wire	24 V	12 V	A93V*2			A93	—	●	●	●	●	—	IC circuit						
																									—	—	—	—	—		—	—	—	—		
Grommet	Grommet	Yes			No					2-wire		24 V	12 V	A90V							A90				—	●	●	●	●		—	IC circuit				
																										—	—	—	—		—		—	—	—	—
Grommet	Grommet		Yes	No			2-wire	24 V	12 V		—				B54							B64				—	●	●	●		●		—	—		
																											—	—	—		—		—		—	—
Grommet	Grommet					Yes										No	2-wire	24 V	12 V	—			C73C	C80C			—	●	●	●	●		—		IC circuit	
																												—	—	—	—		—			—
Grommet	Grommet	Yes			No					2-wire		24 V	12 V	—							B59W				—			—	●	●	●	●	—			—
																													—	—	—	—	—			

*1 Water resistant type auto switches can be mounted on the above models, but in such case SMC cannot guarantee water resistance.
 *2 A water resistant type cylinder is recommended for use in an environment which requires water resistance. However, please contact SMC for water-resistant products of ø20 and ø25.
 *3 2 m type lead wire is only applicable to D-A93.
 *4 Lead wire length symbols: 0.5 m Nil (Example) M9NW
 1 m M (Example) M9NWM
 3 m L (Example) M9NL
 5 m Z (Example) M9NZ
 None N (Example) H7CN
 * Solid state auto switches marked with "○" are produced upon receipt of order.
 * The D-G5□/K5□/B5□/B6□ types cannot be mounted on the bore size ø40.
 * Since there are other applicable auto switches than listed above, refer to page 376 for details.
 * For details about auto switches with pre-wired connector, refer to pages 1648 and 1649.
 * The D-A9□(V)/M□□(V)/M9□□(V)/M9□□(V) type auto switches are shipped together, (but not assembled). (However, auto switch mounting brackets are assembled when being shipped.)



- CJ1
- CJP
- CJ2
- JCM
- CM2
- CM3
- CG1
- CG3**
- JMB
- MB
- MB1
- CA2
- CS1
- CS2

- D-□
- X□
- Technical Data

Symbol

Rubber bumper



Refer to pages 373 to 376 for cylinders with auto switches.

- Auto switch proper mounting position (detection at stroke end) and its mounting height
- Minimum stroke for auto switch mounting
- Operating range
- Auto switch mounting brackets/Part no.



Made to Order
[Click here for details](#)

Symbol	Specification
-XA□	Change of rod end shape

Specifications

Bore size (mm)		20	25	32	40	50	63	80	100
Action		Double acting, Single rod							
Lubrication		Not required (Non-lube)							
Fluid		Air							
Proof pressure		1.0 MPa							
Maximum operating pressure		0.7 MPa							
Minimum operating pressure		0.05 MPa							
Ambient and fluid temperature		Without auto switch: -10 to 70°C (No freezing)							
		With auto switch: -10 to 60°C (No freezing)							
Piston speed		50 to 1000 mm/s							30 to 700 mm/s
Stroke length tolerance		+ ^{1.4} ₀ mm							
Cushion		Rubber bumper							
Mounting		Basic, Foot, Rod flange, Head flange, Clevis							
Allowable kinetic energy	Male rod end	0.2 J	0.29 J	0.46 J	0.84 J	1.4 J	2.38 J	4.13 J	6.93 J
	Female rod end	0.11 J	0.18 J	0.29 J	0.52 J	0.91 J	1.54 J	2.71 J	4.54 J

* Operate the cylinder within the allowable kinetic energy. Refer to page 368 for details.

Standard Strokes

Bore size (mm)	Standard stroke (mm) ^{Note}
20	25, 50, 75, 100, 125, 150, 200
25	25, 50, 75, 100, 125, 150, 200, 250, 300
32	
40	
50	
63	
80	
100	

Note) Manufacture of intermediate strokes in 1 mm increments is possible. (Spacers are not used.)

Accessories

Mounting		Basic	Foot	Rod flange	Head flange	Clevis
Standard	Rod end nut (male thread)	●	●	●	●	●
	Clevis pin	—	—	—	—	●
Option	Single knuckle joint	●	●	●	●	●
	Double knuckle joint (with pin)*	●	●	●	●	●
	Pivoting bracket	—	—	—	—	●

* A double knuckle joint pin and retaining rings are shipped together.

* For part numbers and dimensions, refer to page 372.

Mounting Brackets/Part No.

Mounting bracket	Order qty.	Bore size (mm)								Contents
		20	25	32	40	50	63	80	100	
Foot	^{Note)} 2	CG-L020	CG-L025	CG-L032	CG-L040	CG-L050	CG-L063	CG-L080	CG-L100	2 feet, 8 mounting bolts
Flange	1	CG3-F020	CG3-F025	CG-F032	CG3-F040	CG-F050	CG-F063	CG-F080	CG-F100	1 flange, 4 mounting bolts
Clevis	1	CG-D020	CG-D025	CG-D032	CG3-D040	CG-D050	CG-D063	CG-D080	CG-D100	1 clevis, 4 mounting bolts, 1 clevis pin, 2 retaining rings
Pivoting bracket	1	CG-020-24A	CG-025-24A	CG-032-24A	CG-040-24A	CG-050-24A	CG-063-24A	CG-080-24A	CG-100-24A	1 pivoting bracket

Note) Order 2 feet per cylinder.

Theoretical Output

Unit: N

Bore size D (mm)	Rod size d (mm)	Operating direction	Piston area (mm ²)	Operating pressure (MPa)					
				0.2	0.3	0.4	0.5	0.6	0.7
20	8	OUT	314	62.8	94.2	125.6	157	188.4	219.8
		IN	264	52.8	79.2	105.6	132	158.4	184.8
25	10	OUT	491	98.2	147.3	196.4	245.5	294.6	343.7
		IN	412	82.4	123.6	164.8	206	247.2	288.4
32	12	OUT	804	160.8	241.2	321.6	402	482.4	562.8
		IN	691	138.2	207.3	276.4	345.5	414.6	483.7
40	14	OUT	1257	251.4	377.1	502.8	628.5	754.2	879.9
		IN	1103	220.6	330.9	441.2	551.5	661.8	772.1
50	18	OUT	1964	392.8	589.2	785.6	982	1178.4	1374.8
		IN	1709	341.8	512.7	683.6	854.5	1025.4	1196.3
63	18	OUT	3117	623.4	935.1	1246.8	1558.5	1870.2	2181.9
		IN	2863	572.6	858.9	1145.2	1431.5	1717.8	2004.1
80	22	OUT	5027	1005.4	1508.1	2010.8	2513.5	3016.2	3518.9
		IN	4646	929.2	1393.8	1858.4	2323	2787.6	3252.2
100	26	OUT	7854	1570.8	2356.2	3141.6	3927	4712.4	5497.8
		IN	7323	1464.6	2196.9	2929.2	3661.5	4393.8	5126.1

Weights

Bore size (mm)		20	25	32	40	50	63	80	100
Basic weight	Basic	0.09	0.14	0.20	0.32	0.66	0.92	1.75	2.74
	Long male rod end (G)	0.10	0.15	0.21	0.34	0.70	0.97	1.84	2.85
	Female rod end (F)	0.08	0.12	0.19	0.29	0.60	0.85	1.61	2.53
Additional weight for bracket	Foot	0.11	0.13	0.16	0.22	0.48	0.72	0.96	1.75
	Flange	0.08	0.10	0.14	0.20	0.34	0.50	0.71	1.35
	Clevis	0.05	0.08	0.15	0.23	0.40	0.68	0.71	1.28
Pivoting bracket		0.08	0.09	0.17	0.25	0.44	0.80	0.98	1.75
Single knuckle joint		0.05	0.09	0.09	0.10	0.22	0.22	0.39	0.57
Double knuckle joint (with pin)		0.05	0.09	0.09	0.13	0.26	0.26	0.64	1.31
Additional weight per 50 mm of stroke		0.05	0.07	0.09	0.13	0.19	0.23	0.31	0.43
Additional weight for switch magnet		0.01	0.01	0.01	0.01	0.01	0.02	0.02	0.04

Calculation: (Example) **CDG3FN20-100** (Built-in magnet, Flange type, ø20, 100 mm stroke)

- Basic weight 0.09 (Basic type, ø20)
- Additional weight for bracket 0.08 (Flange)
- Additional weight for stroke 0.05/50 mm
- Air cylinder stroke 100 mm
- Additional weight for switch magnet 0.01

$$0.09 + 0.08 + 0.05 \times (100/50) + 0.01 = 0.28 \text{ kg}$$

Mounting Procedure

Mounting procedure for clevis

Follow the procedures below when mounting a pivoting bracket on the clevis type.

ø20 to ø63

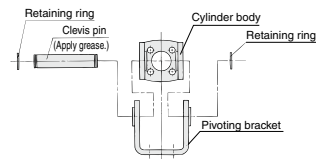

ø80, ø100

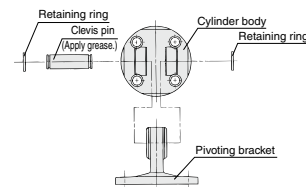

Mounting procedure for rod end nut

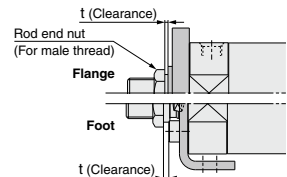

⚠ Caution

1. Tighten clevis bracket mounting bolts with the following proper tightening torque.
ø20: 1.5 N·m, ø25 to ø32: 2.9 N·m, ø40: 4.9 N·m
ø50: 11.8 N·m, ø63 to ø80: 24.5 N·m, ø100: 42.2 N·m
2. For the flange type and the foot type, mount the rod end nut so that distance t (clearance) will be 1 mm or more in order to prevent interference of the nut with the bracket when the rod is retracted.
3. The rod end nut (for male thread) should be mounted so that the hexagon part is on the rod end side. Apply the wrench to the hexagon part.

CJ1
CJP
CJ2
JCM
CM2
CM3
CG1
CG3
JMB
MB
MB1
CA2
CS1
CS2

D-
 -X
 Technical Data

Allowable Kinetic Energy

Table (1) Max. Allowable Kinetic Energy [J]

Bore size (mm)	20	25	32	40	50	63	80	100
Male rod end	0.2	0.29	0.46	0.84	1.4	2.38	4.13	6.93
Female rod end	0.11	0.18	0.29	0.52	0.91	1.54	2.71	4.54

Kinetic energy E (J) = $\frac{(m_1 + m_2) V^2}{2}$

m₁: Mass of cylinder movable parts kg
 m₂: Load mass kg
 V : Piston speed at the end m/s

Table (2) Mass of Cylinder Movable Parts: At Each Rod End/Without Built-in Magnet/0 Stroke [g]

Bore size (mm)	20	25	32	40	50	63	80	100
Basic	30	54	74	121	254	297	603	935
Long male rod end (G)	36	64	89	146	300	343	683	1047
Female rod end (F)	23	40	62	91	184	226	462	728

* Mass of the rod end nut is included for the basic type and the long male rod end type (G).

Table (3) Additional Mass [g]

Bore size (mm)	20	25	32	40	50	63	80	100
Additional mass per 50 mm of stroke	20	31	44	61	99	99	148	207
Switch magnet	4	4	9	13	14	22	24	35

* Do not apply a lateral load over the allowable range to the rod end when it is mounted horizontally.

Calculation: (Example) **CDG3BN40-150**

- Standard mass of movable parts: Table (2) Rod end [Basic], Bore size [40] 121 g
- Additional mass: Additional mass of stroke 61 x 150/50 = 183 g 183 g
- Switch magnet 13 g

Total 317 g

Allowable Lateral Load at Rod End

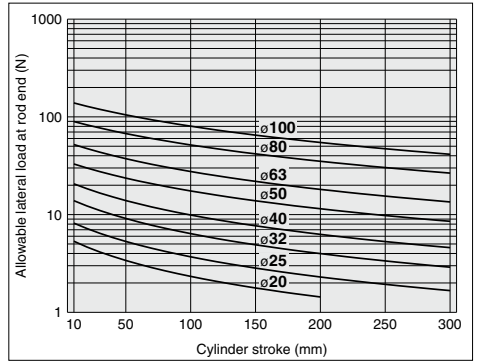

Construction

With rubber bumper

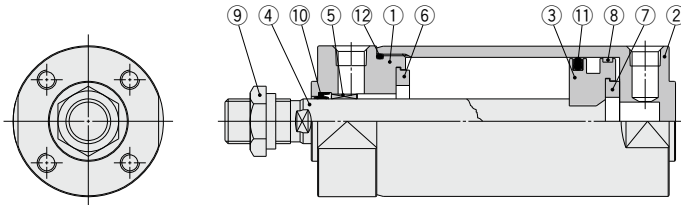

Component Parts

No.	Description	Material	Note
1	Rod cover	Aluminum alloy	Hard anodized
2	Tube cover	Aluminum alloy	Hard anodized
3	Piston	Aluminum alloy	Chromated
4	Piston rod	Carbon steel*	Hard chrome plated*
5	Bushing	Bearing alloy	
6	Bumper A	Resin	
7	Bumper B	Resin	
8	Wear ring	Resin	
9	Rod end nut	Carbon steel	Nickel plated
10	Rod seal	NBR	
11	Piston seal	NBR	
12	Tube gasket	NBR	

Note) In the case of cylinders with auto switches, magnets are installed in the piston.
 * The material for ø20 and ø25 cylinders with auto switches is made of stainless steel.

Replacement Parts/Seal Kit

Bore size (mm)	Kit no.	Contents
20	CG3N20-PS	Set of the nos. (10, 11, 12)
25	CG3N25-PS	
32	CG3N32-PS	
40	CG3N40-PS	

Note) As sizes ø50 and larger cannot be disassembled, the seal cannot be replaced.
 Note) Refer to the following for disassembly/replacement. Order with a part number for each type and bore size.

* The seal kit includes a grease pack (10 g).
 Order with the following part number when only the grease pack is needed.

Grease pack part no.: GR-S-010 (10 g)

Dimensions

Basic: CG3BN **Bore size** – **Stroke**

With rubber bumper

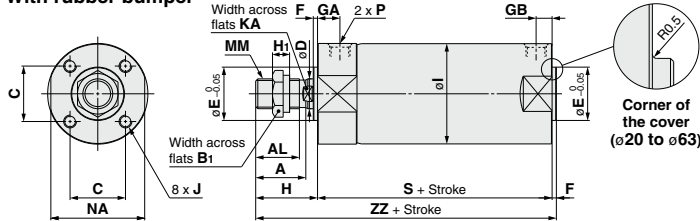

Female rod end

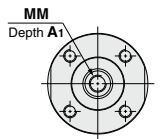

Long male rod end

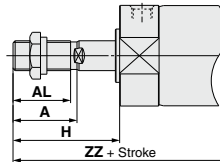

Female Rod End (mm)

Bore size (mm)	Standard stroke	A ₁	H	MM	ZZ
20	Up to 200	8	13	M4 x 0.7	72
25	Up to 300	8	14	M5 x 0.8	76
32	Up to 300	12	14	M6 x 1	78
40	Up to 300	13	15	M8 x 1.25	79
50	Up to 300	18	16	M10 x 1.5	102
63	Up to 300	18	16	M10 x 1.5	102
80	Up to 300	21	19	M14 x 1.5	126
100	Up to 300	25	22	M16 x 1.5	130

Long Male Rod End *2 (mm)

Bore size (mm)	Standard stroke	A	AL	H	ZZ
20	Up to 200	18	15.5	35	94
25	Up to 300	22	19.5	40	102
32	Up to 300	22	19.5	40	104
40	Up to 300	30	27	50	114
50	Up to 300	35	32	58	144
63	Up to 300	35	32	58	144
80	Up to 300	40	37	71	178
100	Up to 300	40	37	71	179

Basic

Bore size (mm)	Standard stroke	A	AL	B ₁	C	D	E	F	GA	GB	H	H ₁	I	J	KA	MM	NA	P	S	ZZ
20	Up to 200	14.5	12	13	14	8	12	2	12	6	20	5	26	M4 x 0.7 depth 7.5	Width across flats 6 length 3.5	M8 x 1.25	24	M5 x 0.8	57	79
25	Up to 300	17.5	15	17	16.5	10	14	2	12.5	7	23	6	31	M5 x 0.8 depth 7.5	Width across flats 8 length 3.5	M10 x 1.25	29	M5 x 0.8	60	85
32	Up to 300	17.5	15	17	20	12	18	2	11	7.5	23	6	38	M5 x 0.8 depth 8	Width across flats 10 length 3.5	M10 x 1.25	35.5	Rc1/8	62	87
40	Up to 300	23.5	20.5	19	26	14	25	2	10.5	7.5	29	8	47	M6 x 1 depth 10	Width across flats 12 length 3.5	M14 x 1.5	44	Rc1/8	62	93
50	Up to 300	29	26	27	32	18	30	2	15	12	35	11	58	M8 x 1.25 depth 16	Width across flats 16 length 4.5	M18 x 1.5	55	Rc1/4	84	121
63	Up to 300	29	26	27	38	18	32	2	15	12	35	11	72	M10 x 1.5 depth 16	Width across flats 16 length 4.5	M18 x 1.5	69	Rc1/4	84	121
80	Up to 300	35.5	32.5	32	50	22	40	3	17	16	44	13	89	M10 x 1.5 depth 22	Width across flats 19 length 4.5	M22 x 1.5	80	Rc1/4	104	151
100	Up to 300	35.5	32.5	41	60	26	50	3	20	16	44	16	110	M12 x 1.75 depth 22	Width across flats 22 length 4.5	M26 x 1.5	100	Rc3/8	105	152

*1 Use a thin wrench when tightening the piston rod.

*2 Long male rod end type (G) is the same rod end dimensions (A, AL, H) as the CG1 series.

*3 When female thread is used, use a washer, etc. to prevent the contact part at the rod end from being deformed depending on the material of the work piece.

Foot: CG3LN **Bore size** – **Stroke**

With rubber bumper

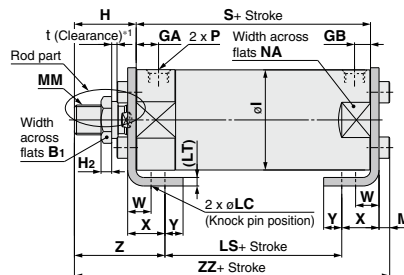
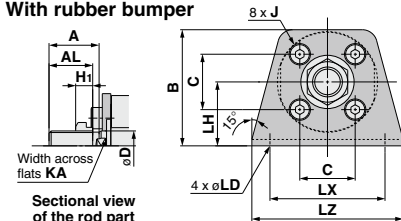

*1 The rod end nut should be mounted in the position t (clearance) so that it will have a clearance of 1 mm or more in order to prevent interference of the nut with the bolt for mounting bracket when the rod is retracted.

Foot

Symbol	A	AL	B	B ₁	C	D	GA	GB	H	H ₁	H ₂	I	J	KA	LC	LD	LS	LT	LX	LZ	M	MM	NA	P	S	W	X	Y	Z	ZZ
20	14.5	12	34	13	14	8	12	6	20	5	4	26	M4 x 0.7	4	6	20	33	(3)	32	44	3	M8 x 1.25	24	M5 x 0.8	57	10	15	7	32	83
25	17.5	15	38.5	17	16.5	10	12.5	7	23	6	4	31	M5 x 0.8	4	6	22	36	(3)	36	49	3.5	M10 x 1.25	29	M5 x 0.8	60	10	15	7	35	89.5
32	17.5	15	45	17	20	12	11	7.5	23	6	4	38	M5 x 0.8	4	7	25	36	(3)	44	58	3.5	M10 x 1.25	35.5	Rc1/8	62	10	16	8	36	91.5
40	23.5	20.5	54.5	19	26	14	10.5	7.5	29	8	5.5	47	M6 x 1	4	7	30	35	(3)	54	71	4	M14 x 1.5	44	Rc1/8	62	10	16.5	8.5	42.5	98
50	29	26	70.5	27	32	18	15	12	35	11	8	58	M8 x 1.25	5	10	40	49	(4.5)	66	86	5	M18 x 1.5	55	Rc1/4	84	17.5	22	11	52.5	128.5
63	29	26	82.5	27	38	18	15	12	35	11	8	72	M10 x 1.5	5	12	45	49	(4.5)	82	106	5	M18 x 1.5	69	Rc1/4	84	17.5	22	13	52.5	128.5
80	35.5	32.5	101	32	50	22	17	16	44	13	9.5	89	M10 x 1.5	6	11	55	56	(4.5)	100	125	5	M22 x 1.5	80	Rc1/4	104	20	28.5	14	68	157.5
100	35.5	32.5	121	41	60	26	20	16	44	16	9.5	110	M12 x 1.75	6	14	65	57	(6)	120	150	7	M26 x 1.5	100	Rc3/8	105	20	30	16	68	162

* Use a thin wrench when tightening the piston rod.

* Refer to the dimensions of the basic type for the female rod end type and the long male rod end type.

CJ1
CJP
CJ2
JCM
CM2
CM3
CG1
CG3
JMB
MB
MB1
CA2
CS1
CS2

D-□
-X□
 Technical Data

CG3 Series

Dimensions

Rod Flange: CG3FN **Bore size** – **Stroke**

With rubber bumper

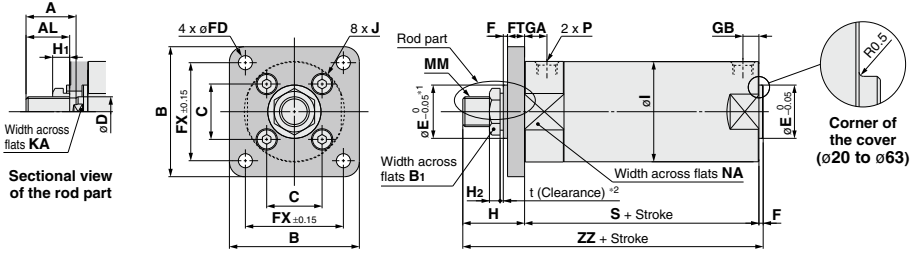

*1 End boss is machined on the flange for ϕE .

*2 The rod end nut should be mounted in the position t (clearance) so that it will have a clearance of 1 mm or more in order to prevent interference of the nut with the bolt for mounting bracket when the rod is retracted.

Rod Flange

Bore size (mm)	Symbol	A	AL	B	B ₁	C	D	E	F	FX	FD	FT	GA	GB	H	H ₁	H ₂	I	J	KA	MM	NA	P	S	ZZ
20		14.5	12	40	13	14	8	12	2	28	5.5	6	12	6	20	5	4	26	M4 x 0.7	Width across flats 6 length 3.5	M8 x 1.25	24	M5 x 0.8	57	79
25		17.5	15	44	17	16.5	10	14	2	32	5.5	7	12.5	7	23	6	4	31	M5 x 0.8	Width across flats 8 length 3.5	M10 x 1.25	29	M5 x 0.8	60	85
32		17.5	15	53	17	20	12	18	2	38	6.6	7	11	7.5	23	6	4	38	M5 x 0.8	Width across flats 10 length 3.5	M10 x 1.25	35.5	Rc1/8	62	87
40		23.5	20.5	61	19	26	14	25	2	46	6.6	8	10.5	7.5	29	8	5.5	47	M6 x 1	Width across flats 12 length 3.5	M14 x 1.5	44	Rc1/8	62	93
50		29	26	76	27	32	18	30	2	58	9	9	15	12	35	11	8	58	M8 x 1.25	Width across flats 16 length 4.5	M18 x 1.5	55	Rc1/4	84	121
63		29	26	92	27	38	18	32	2	70	11	9	17	16	44	13	9.5	89	M10 x 1.5	Width across flats 16 length 4.5	M18 x 1.5	60	Rc1/4	84	121
80		35.5	32.5	104	32	50	22	40	3	82	11	11	17	16	44	13	9.5	89	M10 x 1.5	Width across flats 19 length 4.5	M22 x 1.5	80	Rc1/4	104	151
100		35.5	32.5	128	41	60	26	50	3	100	14	14	20	16	44	16	9.5	110	M12 x 1.75	Width across flats 22 length 4.5	M26 x 1.5	100	Rc3/8	105	152

* Use a thin wrench when tightening the piston rod.

* Refer to the dimensions of the basic type for the female rod end type and the long male rod end type.

Head Flange: CG3GN **Bore size** – **Stroke**

With rubber bumper

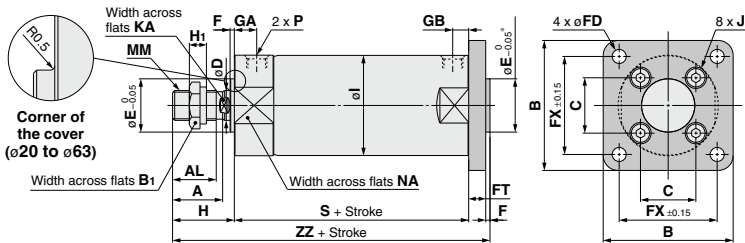

* End boss is machined on the flange for ϕE .

Head Flange

Bore size (mm)	Standard stroke	A	AL	B	B ₁	C	D	E	F	FX	FD	FT	GA	GB	H	H ₁	I	J	KA	MM	NA	P	S	ZZ	
20	Up to 200	14.5	12	40	13	14	8	12	2	28	5.5	6	12	6	20	5	4	26	M4 x 0.7	Width across flats 6 length 3.5	M8 x 1.25	24	M5 x 0.8	57	85
25	Up to 300	17.5	15	44	17	16.5	10	14	2	32	5.5	7	12.5	7	23	6	4	31	M5 x 0.8	Width across flats 8 length 3.5	M10 x 1.25	29	M5 x 0.8	60	92
32	Up to 300	17.5	15	53	17	20	12	18	2	38	6.6	7	11	7.5	23	6	4	38	M5 x 0.8	Width across flats 10 length 3.5	M10 x 1.25	35.5	Rc1/8	62	94
40	Up to 300	23.5	20.5	61	19	26	14	25	2	46	6.6	8	10.5	7.5	29	8	5.5	47	M6 x 1	Width across flats 12 length 3.5	M14 x 1.5	44	Rc1/8	62	101
50	Up to 300	29	26	76	27	32	18	30	2	58	9	9	15	12	35	11	8	58	M8 x 1.25	Width across flats 16 length 4.5	M18 x 1.5	55	Rc1/4	84	130
63	Up to 300	29	26	92	27	38	18	32	2	70	11	9	15	12	35	11	7.2	89	M10 x 1.5	Width across flats 16 length 4.5	M18 x 1.5	60	Rc1/4	84	130
80	Up to 300	35.5	32.5	104	32	50	22	40	3	82	11	11	17	16	44	13	8.9	110	M10 x 1.5	Width across flats 19 length 4.5	M22 x 1.5	80	Rc1/4	104	162
100	Up to 300	35.5	32.5	128	41	60	26	50	3	100	14	14	20	16	44	16	11.0	110	M12 x 1.75	Width across flats 22 length 4.5	M26 x 1.5	100	Rc3/8	105	166

* Use a thin wrench when tightening the piston rod.

* Refer to the dimensions of the basic type for the female rod end type and the long male rod end type.

Dimensions

Clevis: CG3DN **Bore size** – **Stroke** (ø20 to ø63)

With rubber bumper

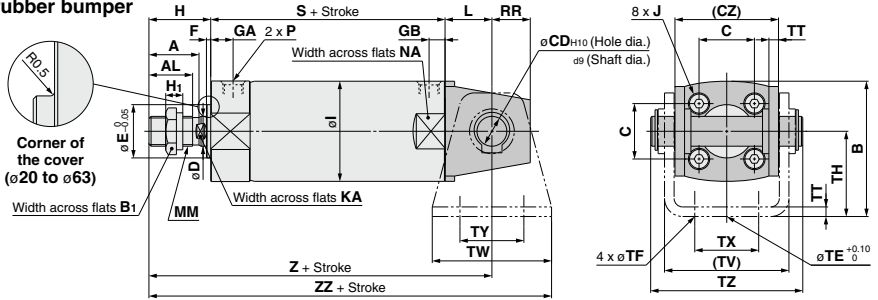

Clevis (ø20 to ø63)

Bore size (mm)	Standard stroke	A	AL	B	B ₁	C	CD	CZ	D	E	F	GA	GB	H	H ₁	I	J	KA	L	MM
20	Up to 200	14.5	12	38	13	14	8 (29)	8	12	2	12	6	20	5	26	M4 x 0.7	Width across flats 6 length 3.5	14	M8 x 1.25	
25	Up to 300	17.5	15	45.5	17	16.5	10 (33)	10	14	2	12.5	7	23	6	31	M5 x 0.8	Width across flats 8 length 3.5	16	M10 x 1.25	
32	Up to 300	17.5	15	54	17	20	12 (40)	12	18	2	11	7.5	23	6	38	M5 x 0.8	Width across flats 10 length 3.5	20	M10 x 1.25	
40	Up to 300	23.5	20.5	63.5	19	26	14 (49)	14	25	2	10.5	7.5	29	8	47	M6 x 1	Width across flats 12 length 3.5	22	M14 x 1.5	
50	Up to 300	29	26	79	27	32	16 (60)	18	30	2	15	12	35	11	58	M8 x 1.25	Width across flats 16 length 4.5	25	M18 x 1.5	
63	Up to 300	29	26	96	27	38	18 (74)	18	32	2	15	12	35	11	72	M10 x 1.5	Width across flats 16 length 4.5	30	M18 x 1.5	

Bore size (mm)	Standard stroke	NA	P	RR	S	TE	TF	TH	TT	TV	TW	TX	TY	TZ	Z	ZZ	Applicable pin part no.
20	Up to 200	24	M5 x 0.8	11	57	10	5.5	25	3.2 (35.8)	42	16	28	43.4	91	112	CD-G02	
25	Up to 300	29	M5 x 0.8	13	60	10	5.5	30	3.2 (39.8)	42	20	28	48	99	120	CD-G25	
32	Up to 300	35.5	Rc1/8	15	62	10	6.6	35	4.5 (49.4)	48	22	28	59.4	105	129	CD-G03	
40	Up to 300	44	Rc1/8	18	62	10	6.6	40	4.5 (58.4)	56	30	30	71.4	113	141	CD-G04	
50	Up to 300	55	Rc1/4	20	84	20	9	50	6 (72.4)	64	36	36	86	144	176	CD-G05	
63	Up to 300	69	Rc1/4	22	84	20	11	60	8 (90.4)	74	46	46	105.4	149	186	CD-G06	

* Use a thin wrench when tightening the piston rod. * Refer to the dimensions of the basic type for the female rod end type and the long male rod end type.
* Refer to page 372 for pivoting bracket.

Clevis: CG3DN **Bore size** – **Stroke** (ø80, ø100)

With rubber bumper

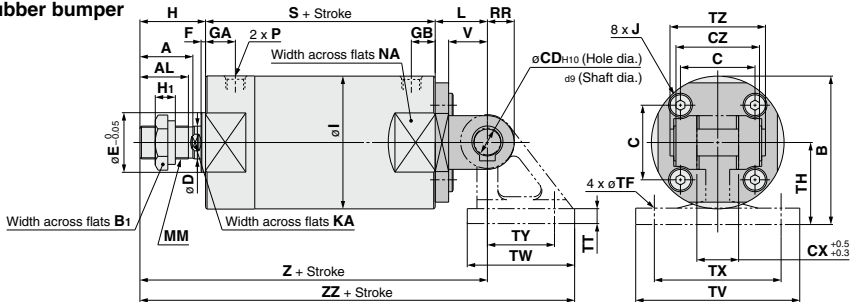

Clevis (ø80, ø100)

Bore size (mm)	Standard stroke	A	AL	B	B ₁	C	CD	CX	CZ	D	E	F	GA	GB	H	H ₁	I	J	KA	L
80	Up to 300	35.5	32.5	99.5	32	50	18	28	56	22	40	3	17	16	44	13	89	M10 x 1.5	Width across flats 19 length 4.5	35
100	Up to 300	35.5	32.5	120	41	60	22	32	64	26	50	3	20	16	44	16	110	M12 x 1.75	Width across flats 22 length 4.5	43

Bore size (mm)	Standard stroke	MM	NA	P	RR	S	TF	TH	TT	TV	TW	TX	TY	TZ	V	Z	ZZ	Applicable pin part no.
80	Up to 300	M22 x 1.5	80	Rc1/4	18	104	11	55	11	110	72	85	45	64	26	183	241.5	IY-G08
100	Up to 300	M26 x 1.5	100	Rc3/8	22	105	13.5	65	12	130	93	100	60	72	32	192	268.5	IY-G10

* Use a thin wrench when tightening the piston rod. * Refer to the dimensions of the basic type for the female rod end type and the long male rod end type.
* Refer to page 372 for pivoting bracket.

- CG1
- CG2
- CG3
- JMB
- MB
- MB1
- CA2
- CS1
- CS2

- D-□
- X□

Technical Data

Dimensions of Accessories

Single Knuckle Joint

I-G02, I-G03

Material: Carbon steel

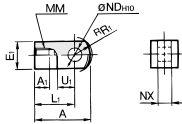

I-G04, I-G05, I-G08, I-G10

Material: Cast iron

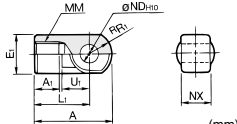

Part no.	Applicable bore size (mm)	A	A1	E1	L1	MM	R1	U1	ND _{H10}	NX
I-G02	20	34	8.5	□16	25	M8 x 1.25	10.3	11.5	8 ^{+0.058} ₋₀	8 ^{-0.2} _{-0.4}
I-G03	25, 32	41	10.5	□20	30	M10 x 1.25	12.8	14	10 ^{+0.058} ₋₀	10 ^{-0.2} _{-0.4}
I-G04	40	42	14	□22	30	M14 x 1.5	12	14	10 ^{+0.058} ₋₀	18 ^{-0.3} _{-0.5}
I-G05	50, 63	56	18	□28	40	M18 x 1.5	16	20	14 ^{+0.070} ₋₀	22 ^{-0.3} _{-0.5}
I-G08	80	71	21	□38	50	M22 x 1.5	21	27	18 ^{+0.070} ₋₀	28 ^{-0.3} _{-0.5}
I-G10	100	79	24	□44	55	M26 x 1.5	24	31	22 ^{+0.084} ₋₀	32 ^{-0.3} _{-0.5}

Knuckle Pin

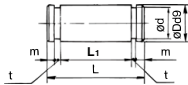

Material: Iron (mm)

Part no.	Applicable bore size (mm)	Dd9	L	d	L1	m	t	Included retaining ring
IY-G02	20	8 ^{-0.040} _{-0.076}	21	7.6	16.2	1.5	0.9	Type C8 for axis
IY-G03	25, 32	10 ^{-0.040} _{-0.076}	25.6	9.6	20.2	1.55	1.15	Type C10 for axis
IY-G04	40	10 ^{-0.040} _{-0.076}	41.6	9.6	36.2	1.55	1.15	Type C10 for axis
IY-G05	50, 63	14 ^{-0.050} _{-0.095}	50.6	13.4	44.2	2.05	1.15	Type C14 for axis
IY-G08	80	18 ^{-0.050} _{-0.093}	64	17	56.2	2.55	1.35	Type C18 for axis
IY-G10	100	22 ^{-0.065} _{-0.117}	72	21	64.2	2.55	1.35	Type C22 for axis

* Retaining rings are included.

Clevis Pin

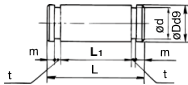

Material: Carbon steel (mm)

Part no.	Applicable bore size (mm)	Dd9	L	d	L1	m	t	Included retaining ring
CD-G02	20	8 ^{-0.040} _{-0.076}	43.4	7.6	38.6	1.5	0.9	Type C8 for axis
CD-G25	25	10 ^{-0.040} _{-0.076}	48	9.6	42.6	1.55	1.15	Type C10 for axis
CD-G03	32	12 ^{-0.050} _{-0.093}	59.4	11.5	54	1.55	1.15	Type C12 for axis
CD-G04	40	14 ^{-0.050} _{-0.093}	71.4	13.4	65	2.05	1.15	Type C14 for axis
CD-G05	50	16 ^{-0.050} _{-0.093}	86	15.2	79.6	2.05	1.15	Type C16 for axis
CD-G06	63	18 ^{-0.050} _{-0.093}	105.4	17	97.8	2.45	1.35	Type C18 for axis

* Retaining rings are included.

* A clevis pin and a knuckle pin are common for the bore size ø80 and ø100.

Rod End Nut (For Male Thread)

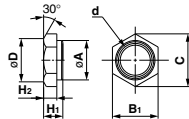

Material: Carbon steel (mm)

Part no.	Applicable bore size (mm)	d	H1	H2	B1	C	øD	øA
NT-02G3	20	M8 x 1.25	5	4	13	(15)	12.5	10
NT-03G3	25, 32	M10 x 1.25	6	4	17	(19.6)	16.5	12
NT-04G3	40	M14 x 1.5	8	5.5	19	(21.9)	18	16.4
NT-05G3	50, 63	M18 x 1.5	11	8	27	(31.2)	26	20.4
NT-08G3	80	M22 x 1.5	13	9.5	32	(37)	31	28
NT-10G3	100	M26 x 1.5	16	9.5	41	(47.3)	39	33

Double Knuckle Joint

Y-G02, Y-G03

Material: Carbon steel

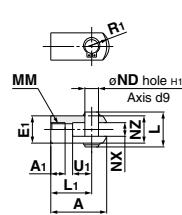

Y-G04, Y-G05, Y-G08, Y-G10

Material: Cast iron

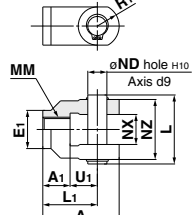

Part no.	Applicable bore size (mm)	A	A1	E1	L1	MM	R1	U1	ND	NX	NZ	L	Included pin part no.
Y-G02	20	34	8.5	□16	25	M8 x 1.25	10.3	11.5	8	8 ^{+0.4} _{-0.2}	16	21	IY-G02
Y-G03	25, 32	41	10.5	□20	30	M10 x 1.25	12.8	14	10	10 ^{+0.4} _{-0.2}	20	25.6	IY-G03
Y-G04	40	42	16	□22	30	M14 x 1.5	12	14	10	18 ^{+0.5} _{-0.3}	36	41.6	IY-G04
Y-G05	50, 63	56	20	□28	40	M18 x 1.5	16	20	14	22 ^{+0.5} _{-0.3}	44	50.6	IY-G05
Y-G08	80	71	23	□38	50	M22 x 1.5	21	27	18	28 ^{+0.5} _{-0.3}	56	64	IY-G08
Y-G10	100	79	24	□44	55	M26 x 1.5	24	31	22	32 ^{+0.5} _{-0.3}	64	72	IY-G10

* A knuckle pin and retaining rings are included.

Pivoting Bracket (Order separately)

ø20 to ø63 Material: Carbon steel

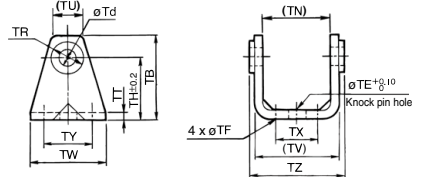

ø80, ø100 Material: Cast iron

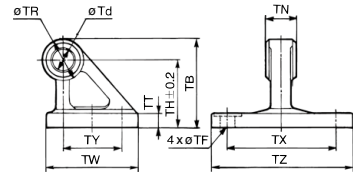

Part no.	Applicable bore size (mm)	TB	Td	TE	TF	TH	TN	TR	TT
CG-020-24A	20	36	8	10	5.5	25 (29.3)	13	3.2	3.2
CG-025-24A	25	43	10	10	5.5	30 (33.1)	15	3.2	3.2
CG-032-24A	32	50	12	10	6.6	35 (40.4)	17	4.5	4.5
CG-040-24A	40	58	14	10	6.6	40 (49.2)	21	4.5	4.5
CG-050-24A	50	70	16	20	9	50 (60.4)	24	6	6
CG-063-24A	63	82	18	20	11	60 (74.6)	26	8	8
CG-080-24A	80	73	18	—	11	55 (28.3)	36	11	11
CG-100-24A	100	90	22	—	13.5	65 (32.3)	50	12	12

Part no.	Applicable bore size (mm)	TU	TV	TW	TX	TY	TZ	Applicable pin O.D
CG-020-24A	20	(18.1)	(35.8)	42	16	28	38.3	8 ^{+0.040} _{-0.040}
CG-025-24A	25	(20.7)	(39.8)	42	20	28	42.1	10 ^{+0.040} _{-0.040}
CG-032-24A	32	(23.6)	(49.4)	48	22	28	53.8	12 ^{+0.050} _{-0.050}
CG-040-24A	40	(27.3)	(58.4)	56	30	30	64.6	14 ^{+0.050} _{-0.050}
CG-050-24A	50	(29.7)	(72.4)	64	36	36	79.2	16 ^{+0.050} _{-0.050}
CG-063-24A	63	(34.3)	(90.4)	74	46	46	97.2	18 ^{+0.050} _{-0.050}
CG-080-24A	80	—	—	72	85	45	110	18 ^{+0.050} _{-0.050}
CG-100-24A	100	—	—	93	100	60	130	22 ^{+0.065} _{-0.117}

Auto Switch Mounting

Auto Switch Proper Mounting Position (Detection at stroke end) and Its Mounting Height

Solid state auto switch

D-M9□, M9□W/D-M9□A
 ø20 to ø63

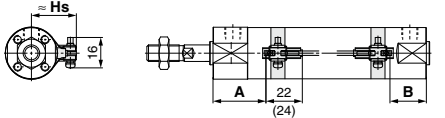

() : Dimension of the D-M9□A.
 A and B are the dimensions from the end of the head cover/rod cover to the end of the auto switch.

D-M9□V, M9□WV/D-M9□AV
 ø20 to ø63

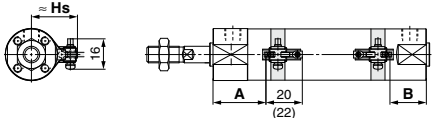

() : Dimension of the D-M9□A.
 A and B are the dimensions from the end of the head cover/rod cover to the end of the auto switch.

D-G5, K5, G5□W, G5BA
 D-K59W, D-G59F, D-G5NT
 ø20 to ø100

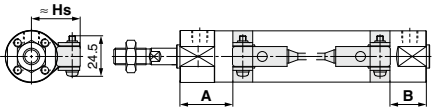

D-H7□, H7□W
 D-H7NF, H7BA, D-H7C
 ø20 to ø63

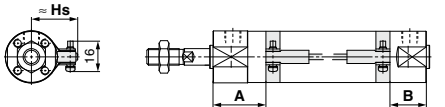

Reed auto switch

D-A9□
 ø20 to ø63

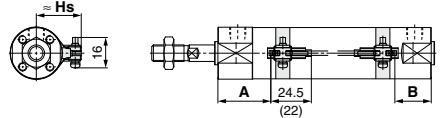

() : Dimension of the D-A9□.
 A and B are the dimensions from the end of the head cover/rod cover to the end of the auto switch.

D-A9□V
 ø20 to ø63

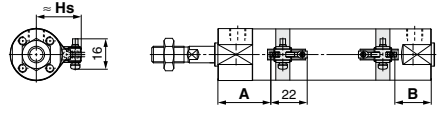

A and B are the dimensions from the end of the head cover/rod cover to the end of the auto switch.

D-C7, C8/D-C73C, C80C
 ø20 to ø63

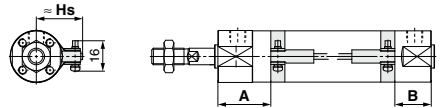

D-B5, B6, B59W
 ø20 to ø100

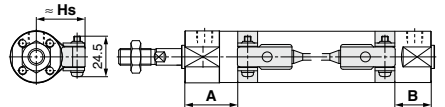

Auto Switch Proper Mounting Position

Auto switch model	D-M9□(V) D-M9□W(V) D-M9□A(V)		D-A9□(V)		D-C7/C8 D-C73C D-C80C		D-B5 D-B6		D-B59W		D-H7□ D-H7C D-H7□W D-H7BA D-H7NF		D-G5□W D-K59W D-G59F D-G5 D-K5 D-G5NT D-G5BA	
	A	B	A	B	A	B	A	B	A	B	A	B	A	B
20	28.5	16.5	24.5	12.5	25	13	19	8	22	10	24	12	20.5	8.5
25	29	19	25	15	25.5	15.5	19.5	9.5	22.5	12.5	24.5	14.5	21	11
32	30.5	19.5	26.5	15.5	27	16	21	10	24	13	26	15	22.5	11.5
40	31	19	27	15	27.5	15.5	—	—	—	—	26.5	14.5	—	—
50	42.5	29.5	38.5	25.5	39	26	33	20	36	23	38	25	34.5	21.5
63	42.5	29.5	38.5	25.5	39	26	33	20	36	23	38	25	34.5	21.5
80	—	—	—	—	—	—	44	29	47	31.5	—	—	45.5	30.5
100	—	—	—	—	—	—	44	30	47	32.5	—	—	45.5	31.5

Auto Switch Mounting Height

Auto switch model	D-M9□V D-M9□WV D-M9□AV D-A9□V		D-M9□ D-M9□A D-A9□		D-H7□ D-H7□W D-H7NF D-H7BA D-C7/C8		D-C73C D-C80C		D-G5/K5 D-G5NT D-G59F D-H7C D-H7C D-K59W D-B5/B6 D-B59W	
	Hs	Hs	Hs	Hs	Hs	Hs	Hs	Hs	Hs	
20	25.5	24.5	27	27.5	—	—	—	—	—	
25	28	27	29.5	30	—	—	—	—	—	
32	31.5	30.5	33	33.5	—	—	—	—	—	
40	36	35	37.5	38	—	—	—	—	—	
50	41.5	40.5	43	43.5	—	—	—	—	—	
63	48.5	47.5	50	50.5	—	—	—	—	—	
80	—	—	—	—	—	—	—	—	—	
100	—	—	—	—	—	—	—	—	69.5	

Note 1) Adjust the auto switch after confirming the operating condition in the actual setting.

Note 2) For the combination of the following auto switches, bore sizes and mounting positions, the auto switch cannot be mounted to the port side.

- D-H7□ type ... On the head side of the bore size ø20, ø25, ø32, ø40, ø50, ø63
- D-A9□/C7□/C8 types ... On the head side of the bore size ø20, ø32, ø40
- D-G5□/K5□/B59W types ... On the head side of the bore size ø20, ø25, ø32, ø50, ø63
- D-B5□/B6□ types ... On the head side of the bore size ø20, ø25, ø32, ø50, ø63, ø80, ø100 and the rod side of the bore size ø20, ø25, ø32

CJ1
CJP
CJ2
JCM
CM2
CM3
CG1
CG3
JMB
MB
MB1
CA2
CS1
CS2

D-□
-X□
Technical Data

Minimum Stroke for Auto Switch Mounting

Auto switch model	Number of auto switches (mm)				
	With 1 pc.	With 2 pcs.		With n pcs.	
		Different surfaces	Same surface	Different surfaces	Same surface
D-M9□	5	15 <small>Note 1)</small>	40 <small>Note 1)</small>	$20 + 35 \frac{(n-2)}{2}$ <small>(n = 2, 4, 6...)</small> <small>Note 3)</small>	$55 + 35 (n-2)$ <small>(n = 2, 3, 4, 5...)</small>
D-M9□W	10	15 <small>Note 1)</small>	40 <small>Note 1)</small>	$20 + 35 \frac{(n-2)}{2}$ <small>(n = 2, 4, 6...)</small> <small>Note 3)</small>	$55 + 35 (n-2)$ <small>(n = 2, 3, 4, 5...)</small>
D-M9□A	10	25	40 <small>Note 1)</small>	$25 + 35 \frac{(n-2)}{2}$ <small>(n = 2, 4, 6...)</small> <small>Note 3)</small>	$60 + 35 (n-2)$ <small>(n = 2, 3, 4, 5...)</small>
D-A9□	5	15	30 <small>Note 1)</small>	$15 + 35 \frac{(n-2)}{2}$ <small>(n = 2, 4, 6...)</small> <small>Note 3)</small>	$50 + 35 (n-2)$ <small>(n = 2, 3, 4, 5...)</small>
D-M9□V	5	20	35	$20 + 35 \frac{(n-2)}{2}$ <small>(n = 2, 4, 6...)</small> <small>Note 3)</small>	$35 + 35 (n-2)$ <small>(n = 2, 3, 4, 5...)</small>
D-A9□V	5	15	25	$15 + 35 \frac{(n-2)}{2}$ <small>(n = 2, 4, 6...)</small> <small>Note 3)</small>	$25 + 35 (n-2)$ <small>(n = 2, 3, 4, 5...)</small>
D-M9□WV D-M9□AV	10	20	35	$20 + 35 \frac{(n-2)}{2}$ <small>(n = 2, 4, 6...)</small> <small>Note 3)</small>	$35 + 35 (n-2)$ <small>(n = 2, 3, 4, 5...)</small>
D-C7□ D-C80	5	20	60	$20 + 45 \frac{(n-2)}{2}$ <small>(n = 2, 4, 6...)</small> <small>Note 3)</small>	$60 + 45 (n-2)$ <small>(n = 2, 3, 4, 5...)</small>
D-H7□ D-H7□W D-H7BA D-H7NF	10	25	70	$25 + 45 \frac{(n-2)}{2}$ <small>(n = 2, 4, 6...)</small> <small>Note 3)</small>	$70 + 45 (n-2)$ <small>(n = 2, 3, 4, 5...)</small>
D-C73C D-C80C D-H7C	5	30	80	$30 + 50 \frac{(n-2)}{2}$ <small>(n = 2, 4, 6...)</small> <small>Note 3)</small>	$80 + 50 (n-2)$ <small>(n = 2, 3, 4, 5...)</small>
D-B5□ D-B64 D-G5□ D-K59□	5	25	70	$25 + 50 \frac{(n-2)}{2}$ <small>(n = 2, 4, 6...)</small> <small>Note 3)</small>	$70 + 50 (n-2)$ <small>(n = 2, 3, 4, 5...)</small>
D-B59W	10	30	75	$30 + 50 \frac{(n-2)}{2}$ <small>(n = 2, 4, 6...)</small> <small>Note 3)</small>	$75 + 50 (n-2)$ <small>(n = 2, 3, 4, 5...)</small>

Note 3) When "n" is an odd number, an even number that is one larger than this odd number is used for the calculation.

Note 1) Auto switch mounting

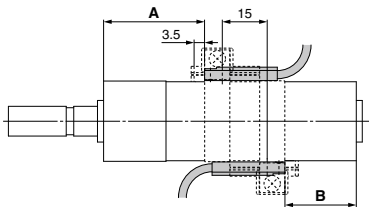
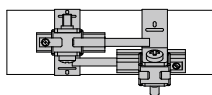
Auto switch model	With 2 auto switches	
	Different surfaces	Same surface
	 <p>The auto switch proper mounting position is 3.5 mm from the back face of the switch holder.</p>	 <p>The auto switch is mounted by slightly displacing it in a direction (cylinder tube circumferential exterior) so that the auto switch and lead wire do not interfere with each other.</p>
D-M9□ D-M9□W	Less than 20 mm stroke <small>Note 2)</small>	Less than 55 mm stroke <small>Note 2)</small>
D-M9□A	Less than 20 mm stroke <small>Note 2)</small>	Less than 60 mm stroke <small>Note 2)</small>
D-A9□	—	Less than 50 mm stroke <small>Note 2)</small>

Note 2) Minimum stroke for auto switch mounting in types other than those mentioned in Note 1

Auto Switch Mounting Brackets/Part No.

Auto switch model	Bore size (mm)							
	20	25	32	40	50	63	80	100
D-M9□(V) D-M9□W(V) D-A9□(V)	Note 1) BMA3-020	Note 1) BMA3-025	Note 1) BMA3-032	Note 1) BMA3-040	Note 1) BMA3-050	Note 1) BMA3-063	—	—
D-M9□A(V)	Note 2) BMA3-020S	Note 2) BMA3-025S	Note 2) BMA3-032S	Note 2) BMA3-040S	Note 2) BMA3-050S	Note 2) BMA3-063S	—	—
D-C7□/C80 D-C73C/C80C D-H7□ D-H7□W D-H7NF	BMA2-020A	BMA2-025A	BMA2-032A	BMA2-040A	BMA2-050A	BMA2-063A	—	—
D-H7BA	BMA2-020AS	BMA2-025AS	BMA2-032AS	BMA2-040AS	BMA2-050AS	BMA2-063AS	—	—
D-B5□/B64 D-B59W D-G5□/K59 D-G5□W/K59F D-G5BA/G59F D-G5NT	BA-01	BA-02	BA-32	BA-04	BA-05	BA-06	BA-08	BA-10

Note 1) Set part number which includes the auto switch mounting band (BMA2-□□□A) and the holder kit (BJ5-1/Switch bracket: Transparent).
 Since the switch bracket (made from nylon) are affected in an environment where alcohol, chloroform, methylamines, hydrochloric acid or sulfuric acid is splashed over, so it cannot be used. Please consult SMC regarding other chemicals.

Note 2) Set part number which includes the auto switch mounting band (BMA2-□□□AS/Stainless steel screw) and the holder kit (BJ4-1/Switch bracket: White).

For the D-M9□A (V) type auto switch, do not install the switch bracket on the indicator light.

[Stainless Steel Mounting Screw]

The following stainless steel mounting screw kit is available. Use it in accordance with the operating environment.
 (Since the auto switch mounting bracket is not included, order it separately.)

BBA3: D-B5, B6, G5, K5 types

BBA4: D-C7, C80, H7 types

Note 3) Refer to page 1681 for details on the BBA3.

The above stainless steel screws are used when a cylinder is shipped with the D-H7BA/G5BA auto switches.
 When only an auto switch is shipped independently, the BBA3 or BBA4 is attached.

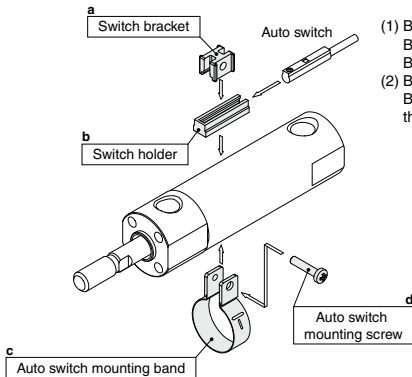

- (1) BJ□-1 is a set of "a" and "b".
 BJ4-1 (Switch bracket: White)
 BJ5-1 (Switch bracket: Transparent)
- (2) BMA2-□□□A(S) is a set of "c" and "d".
 Band (c) is mounted so that the projected part is on the internal side (contact side with the tube).

- CG1
- CJP
- CJ2
- JCM
- CM2
- CM3
- CG1
- CG3
- JMB
- MB
- MB1
- CA2
- CS1
- CS2



- D-□
- X□
- Technical Data

Operating Range

Auto switch model	Bore size (mm)							
	20	25	32	40	50	63	80	100
D-M9□(V) D-M9□W(V) D-M9□A(V)	4.5	5.0	4.5	5.5	5.0	5.5	—	—
D-A9□	7	6	8	8	8	9	—	—
D-C7/C80 D-C73C/C80C	8	10	9	10	10	11	—	—
D-B5□/B64 D-B59W	8	10	9	10	10	11	11	11
D-H7□/H7□W D-H7NF/H7BA	4	4	4.5	5	6	6.5	—	—
D-H7C	7	8.5	9	10	9.5	10.5	—	—
D-G5□/G5□W/G59F D-G5BA/K59/K59W	4	4	4.5	5	6	6.5	6.5	7
D-G5NT	4	4	4.5	5	6	6.5	6.5	7

* Values which include hysteresis are for guideline purposes only, they are not a guarantee (assuming approximately ±30% dispersion) and may change substantially depending on the ambient environment.

Cylinder Mounting Bracket, by Stroke/Auto Switch Mounting Surfaces

Auto switch model	Basic, Foot, Flange, Clevis st: Stroke (mm)		
	With 1 pc. (Rod cover side)	With 2 pcs. (Different surfaces)	With 2 pcs. (Same surface)
Auto switch mounting surface	Port side 	Port side 	Port side 
Auto switch model			
D-M9□(V) D-M9□W(V) D-M9□A(V) D-A9□	10 st or more	15 to 44 st	45 st or more
D-C7/C8	10 st or more	15 to 49 st	50 st or more
D-H7□/H7□W D-H7BA/H7NF	10 st or more	15 to 59 st	60 st or more
D-C73C/C80C/H7C	10 st or more	15 to 64 st	65 st or more
D-B5/B6/G5/K5 D-G5□W/K59W/G5BA D-G59F/G5NT	10 st or more	15 to 74 st	75 st or more
D-B59W	15 st or more	20 to 74 st	75 st or more

Other than the applicable auto switches listed in “How to Order”, the following auto switches are mountable.

Refer to pages 1575 to 1701 for detailed specifications.

Type	Model	Electrical entry	Features	Applicable bore size	
Solid state	D-H7A1, H7A2, H7B	Grommet (In-line)	—	ø20 to ø63	
	D-H7NW, H7PW, H7BW		Diagnostic indication (2-color indicator)		
	D-H7BA		Water resistant (2-color)		
	D-G5NT		With timer	ø20 to ø100	
Reed	D-C73, C76		Grommet (In-line)	—	ø20 to ø63
	D-C80			Without indicator light	
	D-B53	—		ø20 to ø100	

* With pre-wired connector is also available for solid state auto switches. For details, refer to pages 1648 and 1649.

* Normally closed (NC = b contact) solid state auto switches (D-M9□E(V)) are also available. For details, refer to page 1592-1.



CG3 Series

Specific Product Precautions 1

Be sure to read this before handling the products. Refer to back page 50 for Safety Instructions and pages 3 to 12 for Actuator and Auto Switch Precautions.

Handling

Warning

1. Operate the cylinder within the specified cylinder speed, kinetic energy and lateral load at the rod end. Otherwise, cylinder and seal damage may occur.
2. The allowable kinetic energy is different between the cylinders with male rod end and with female rod end due to the different thread sizes. Refer to page 368.
3. When the cylinder is used as mounted with a single side fixed or free (basic type, flange type), be careful not to apply vibration or impact to the cylinder body. A bending moment will be applied to the cylinder due to the vibration generated at the stroke end, and the cylinder may be damaged. In such a case, mount a bracket to reduce the vibration of the cylinder or use the cylinder at a piston speed low enough to prevent the cylinder from vibrating at the stroke end. Furthermore, when the cylinder is moved or mounted horizontally and with a single side fixed, use a bracket to fix the cylinder.
4. When female rod end is used, use a washer, etc. to prevent the contact part at the rod end from being deformed depending on the material of the work piece.

Caution

1. Do not use the air cylinder as an air-hydro cylinder. This will result in oil leakage and damage the product.
2. Use a thin wrench when tightening the piston rod.
3. Check the mounting direction of the rod end nut (for male thread). Refer to Mounting Procedure on page 367 for details.
4. There are some changes in the dimensions and the specifications of this model from the current model. Please check them when replacing from the current model. Check the operating conditions and interference with workpieces before use.

Disassembly/Replacement

Warning

1. Only people who have sufficient knowledge and experience are allowed to replace seals.

The person who disassembles and reassembles the cylinder is responsible for the safety of the product. Repeatedly disassembling and reassembling the product may cause wearing or deformation of the screws as well as a decline in screw tightening strength. When reassembling the product, be sure to check the cover and tubing screws for wear, deformities, or any other abnormalities. Operating the product with damaged screws may result in the cover or tubing coming off during operation, which could lead to a serious accident. Caution must be taken to avoid such incidents.

Caution

1. Do not replace the bushings.

The bushings are press-fit. To replace them, they must be replaced together with the cover assembly.

2. To replace a seal, apply grease to the new seal before installing it.

If the cylinder is put into operation without applying grease to the seal, it could cause the seal to wear significantly, leading to premature air leakage.

3. Cylinders with $\phi 50$ or larger bore sizes cannot be disassembled.

When disassembling cylinders with bore sizes $\phi 20$ through $\phi 40$, grip the double flat part of either the head cover or the rod cover with a vise and loosen the other side with a wrench or a monkey wrench, etc., and then remove the cover. When re-tightening, tighten approximately 2 degrees more than the original position. (Cylinders with $\phi 50$ or larger bore sizes are tightened with a large tightening torque and cannot be disassembled. If disassembly is required, please contact SMC.)

4. When replacing seals, take care not to hurt your hand or finger on the corners of parts.

CJ1

CJP

CJ2

JCM

CM2

CM3

CG1

CG3

JMB

MB

MB1

CA2

CS1

CS2

D-□

-X□

Technical Data