

The ZSE30AF-X576 to X580 series high-precision digital pressure switch (for low pressure) is to be discontinued. Consider selecting a ZSE20AF-X576 to X580 as a substitute.
 Discontinuation date
 ZSE30AF-□-X576 March 31, 2023
 ZSE30AF-□-X577, X578, X579 September 30, 2023
 ZSE30AF-□-X580 June 30, 2023



2-Color Display High-Precision Digital Pressure Switch (for Low Pressure)



Able to detect and display pressures of 10 kPa or less

● Rated pressure range

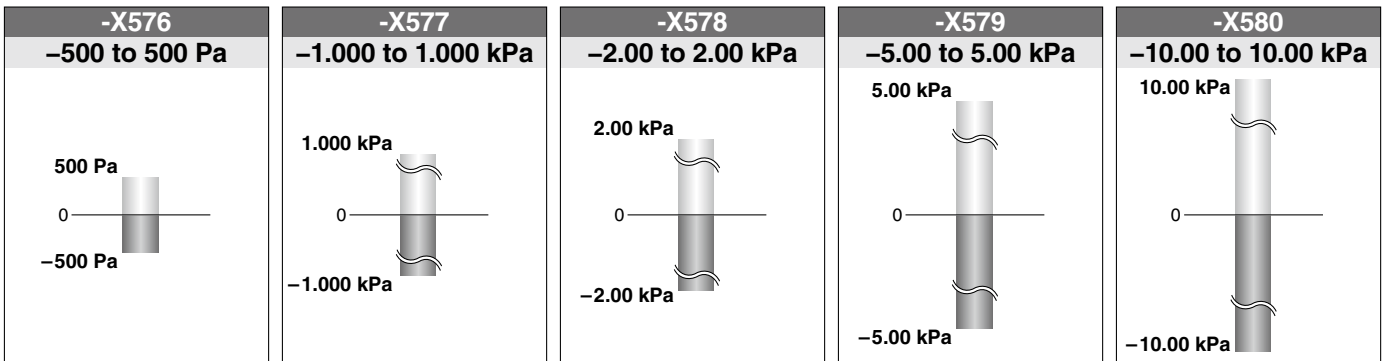

● Can copy to up to 10 switches simultaneously

The set values of the sensor can be copied.
 ●Reduced setting time ●Minimized risk of setting mistakes

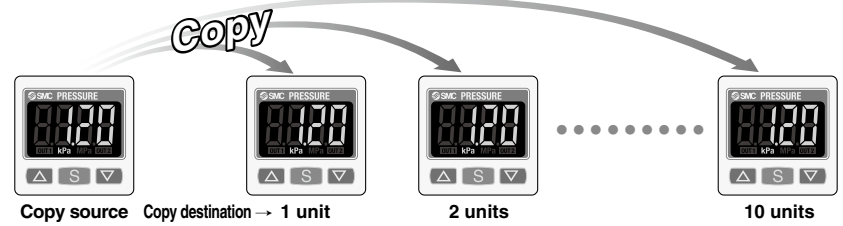

The sensors can be connected by a dedicated lead wire (ZS-38-5L (for 1:1 copy) or ZS-38-U (for 1:10 copy)).

● 3-step setting

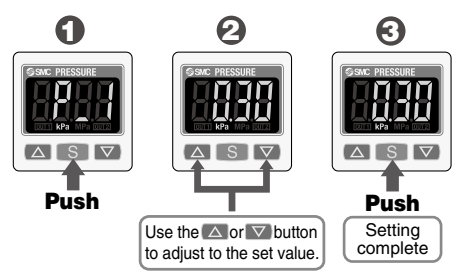

● With display low-cut function (zero-cut function)

"0" is displayed within the effective range.
 Low-cut function "ON": 0 → 0 → 4 → → 500 Pa
 Low-cut function "OFF": 0 → 1 → 2 → 3 → 4 → → 500 Pa

Model	Effective range
-X576	-3 Pa to 3 Pa
-X577	-0.005 kPa to 0.005 kPa
-X578	-0.01 kPa to 0.01 kPa
-X579	-0.03 kPa to 0.03 kPa
-X580	-0.05 kPa to 0.05 kPa

Application Examples

Flow control

Can control air flow by monitoring the flow rate inside the duct

Liquid level detection

Can detect the liquid level through changes in the purge pressure

Liquid Level Detection Range (for water)

Pressure range	Liquid level detection range	Minimum set value
±500 Pa	50 mm	0.1 mm
±1 kPa	100 mm	0.1 mm
±2 kPa	200 mm	1 mm
±5 kPa	500 mm	1 mm
±10 kPa	1000 mm	1 mm

ZSE30AF-X576 to X580



ZSE30AF-X576 to X580

How to Order

ZSE30AF - 01 - A - M - [] - [] - [] - []

Piping specification

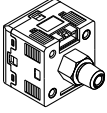
01	R1/8 (M5 female threaded)	
N01	NPT1/8 (M5 female threaded)	

Output specification

A	NPN open collector 2 outputs
B	PNP open collector 2 outputs
C	NPN open collector 1 output + Analog voltage
D	NPN open collector 1 output + Analog current

Unit specification

Nil	With unit selection function*1
M	Fixed SI unit

*1 Under the New Measurement Act, switches with the unit selection function are not permitted for use in Japan.

Available Display Units *1

Model	Rated	kPa	Pa	mbar	psi	inHg	mmHg	inH ₂ O	mmH ₂ O
-X576	±500 Pa	○	○*2	○	○	○	○	○	○
-X577	±1 kPa	○*2	○	○	○	○	○	○	○
-X578	±2 kPa	○*2	○	○	○	○	○	○	○
-X579	±5 kPa	○*2	×	○	○	○	○	○	○
-X580	±10 kPa	○*2	×	○	○	○	○	○	○

*1 This setting is only available for models with the unit selection function.

*2 Setting has been completed by the time of shipment from the factory.

Option 1

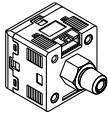
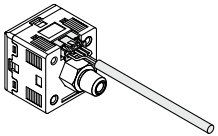
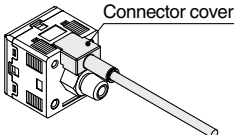
Nil	Without lead wire	
L	Lead wire with connector (Lead wire length 2 m) *1	
G	Lead wire with connector (Lead wire length 2 m) *1 With connector cover	

*1 4-core lead wires

Made to order

Symbol	Rated pressure range
X576	-500 to 500 Pa
X577	-1.000 to 1.000 kPa
X578	-2.00 to 2.00 kPa
X579	-5.00 to 5.00 kPa
X580	-10.00 to 10.00 kPa

Option 3

Symbol	Operation manual*1*2	Calibration certificate*2
Nil	○	—
Y	—	—
K	○	○
T	—	○

*1 Provided with the operation manual of the standard product

*2 All texts in both English and Japanese

Option 2

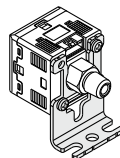
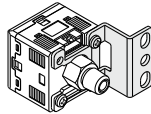
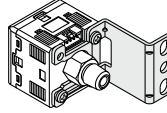
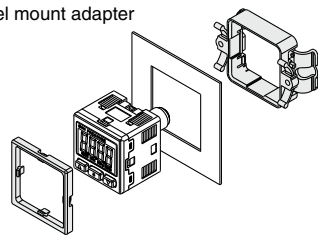
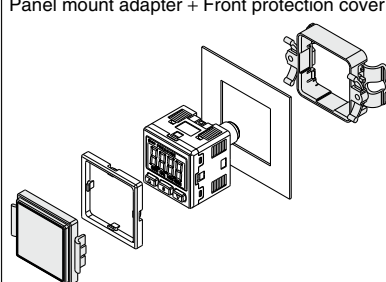
Nil	None	
A1	Bracket A	
A2	Bracket B	
A3	Bracket C	
B	Panel mount adapter	
D	Panel mount adapter + Front protection cover	

2-Color Display High-Precision Digital Pressure Switch (for Low Pressure) **ZSE30AF-X576 to X580**

Specifications

Model	-X576	-X577	-X578	-X579	-X580	
Rated pressure range	-500 to 500 Pa	-1.000 to 1.000 kPa	-2.00 to 2.00 kPa	-5.00 to 5.00 kPa	-10.00 to 10.00 kPa	
Set pressure range	-525 to 525 Pa	-1.050 to 1.050 kPa	-2.10 to 2.10 kPa	-5.25 to 5.25 kPa	-10.50 to 10.50 kPa	
Withstand pressure	2.5 kPa	5 kPa	10 kPa	25 kPa	50 kPa	
Smallest settable increment	1 Pa	0.001 kPa	0.01 kPa	0.01 kPa	0.01 kPa	
Applicable fluid	Air, Non-corrosive gas, Non-flammable gas					
Power supply voltage	12 to 24 VDC $\pm 10\%$, Ripple (p-p) 10% or less					
Current consumption	40 mA or less					
Switch output	NPN or PNP open collector 1 output, NPN or PNP open collector 2 outputs					
Maximum load current	80 mA					
Maximum applied voltage	28 V (at NPN output)					
Residual voltage	1 V or less (with a load current of 80 mA)					
Delay time	4 ms or less*1 (with anti-chattering function: 20 ms, 100 ms, 500 ms, 1000 ms, 2000 ms, 10 s, 30 s, 60 s)					
Short circuit protection	Yes					
Repeatability	$\pm 1\%$ F.S. ± 1 digit					
Hysteresis	Hysteresis mode	Variable (0 or above)				
	Window comparator mode					
Analog output	Voltage output *2	Output voltage (Rated pressure range)	1 to 5 V ± 2.5 F.S.			
		Linearity	$\pm 1.5\%$ F.S.	$\pm 1\%$ F.S.		
		Output impedance	Approx. 1 k Ω			
	Current output *3	Output current (Rated pressure range)	4 to 20 mA $\pm 2.5\%$ F.S.			
		Linearity	$\pm 1.5\%$ F.S.	$\pm 1\%$ F.S.		
	Load impedance	Maximum load impedance: Power supply voltage 12 V: 300 Ω , Power supply voltage 24 V: 600 Ω Minimum load impedance: 50 Ω				
Display	4-digit, 7-segment, 2-color LCD (Red/Green)					
Display accuracy	$\pm 2\%$ F.S. ± 1 digit (Ambient temperature of 25 $\pm 3^\circ\text{C}$)					
Indicator light	Lights up when switch output is turned ON. (OUT1: Green, OUT2: Red)					
Digital filter *4 *5	Rough adjustment mode: 0, 0.2, 0.5, 1 (Initial value), 2, 5, 10, 20 s					
	Fine adjustment mode: 200 to 1000 ms (in 5 ms increments)					
Effective range of display low-cut function *6	± 3 Pa	± 0.005 kPa	± 0.01 kPa	± 0.03 kPa	± 0.05 kPa	
Environment	Enclosure	IP 40				
	Operating temperature range	Operating: 0 to 50 $^\circ\text{C}$ (No freezing or condensation) Stored: -10 to 60 $^\circ\text{C}$ (No freezing or condensation)				
	Operating humidity range	Operating/Stored: 35 to 85% RH (No condensation)				
	Withstand voltage	1000 VAC for 1 minute between terminals and housing				
	Insulation resistance	50 M Ω or more (500 VDC measured via megohmmeter) between terminals and housing				
Temperature characteristics (25 $^\circ\text{C}$ reference)	$\pm 3\%$ F.S.					
Lead wire	Oilproof heavy-duty vinyl cable, 4-core $\phi 3.5$, 2 m Conductor area: 0.15 mm 2 (AWG 26) Insulator O.D.: 1.0 mm					
Standards	CE marking (EMC directive/RoHS directive), UL/CSA(E216656)					
Main materials of parts in contact with fluid	Sensor pressure receiving area: Silicon Piping port: C3602 (Electroless nickel plating), O-ring: HNBR					
Weight	Including lead wire with connector (4-core, 2 m)	85 g				
	Excluding lead wire with connector	43 g				

*1 Value without digital filter (at 0 ms)

*2 Analog voltage output and, analog current output cannot be selected at the same time.

*3 Analog current output and, analog voltage output cannot be selected at the same time.

*4 The digital filter set value affects the pressure display, switch output (OUT1, OUT 2), and analog output response time.

*5 For the digital filter, the response time indicates when the set value is 90% in relation to the step input.

*6 When the display low-cut function is used, "0" is displayed in the effective range.

Other specifications are the same as the standard product. For details, refer to the **Web Catalog**. Click [here](#) for details.

Options/Part Nos.

When optional parts are required separately, use the following part numbers to place an order.

Part no.	Option	Note
ZS-38-A1	Bracket A	Mounting screw (with 2 pcs. of M3 x 5L)
ZS-38-A2	Bracket B	Mounting screw (with 2 pcs. of M3 x 5L)
ZS-38-A3	Bracket C	Mounting screw (with 2 pcs. of M3 x 5L)
ZS-27-C	Panel mount adapter	Mounting screw (with 2 pcs. of M3 x 8L)
ZS-27-D	Panel mount adapter + Front protection cover	Mounting screw (with 2 pcs. of M3 x 8L)
ZS-27-01	Front protection cover	
ZS-38-4L	Lead wire with connector	4-core, for 2 outputs, 2 m
ZS-38-4G	Lead wire with connector (with connector cover)	4-core, for 2 outputs, 2 m
ZS-38-5L	Lead wire with a connector for copying	3-core, copy function, 1 m
ZS-38-U	Lead wire unit with a connector for copying	Copy function (up to 10 units)

ZSE30AF-X576 to X580

Dimensions

ZSE30AF - ⁰¹N01 - □ - □ □ □ □ - X576 to X580

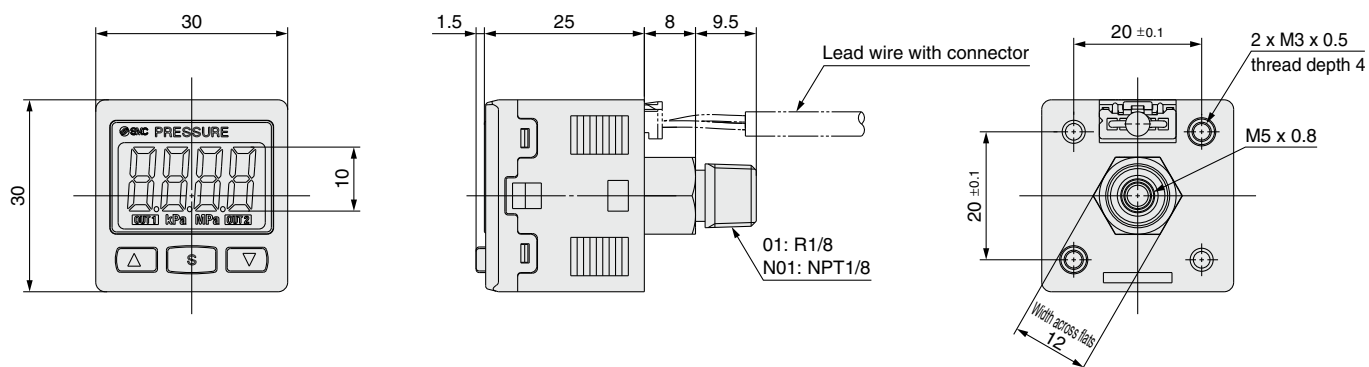

Panel fitting dimensions

1 pc. mounting

Multiple (2 pcs. or more) horizontal mounting

Multiple (2 pcs. or more) vertical mounting

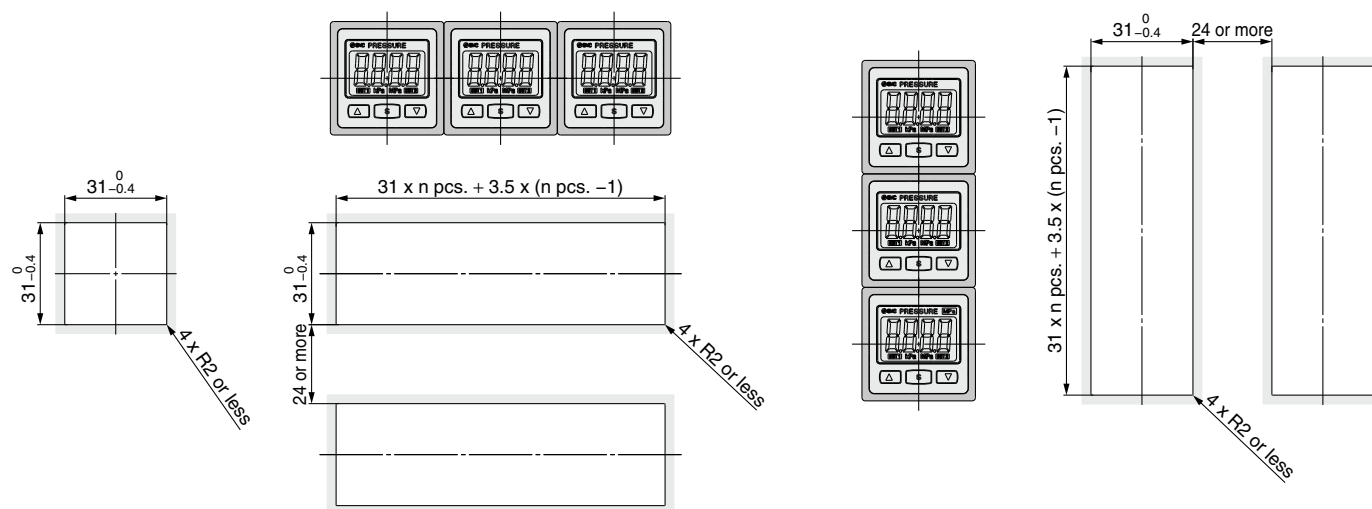

⚠ Precautions

Be sure to read this before handling the products. For safety instructions and pressure switch/flow switch precautions, refer to the "Handling Precautions for SMC Products" and the "Operation Manual" on the SMC website: <http://www.smcworld.com>

Mounting

⚠ Caution

1. Pressure measurements may fluctuate if the housing is exposed to air.
2. Pressure measurements may fluctuate if stress is applied to the housing or piping.

Piping

⚠ Caution

1. The pressure sensor may be damaged if excessive pressure is applied to the piping.

⚠ **Safety Instructions** Be sure to read the "Handling Precautions for SMC Products" (M-E03-3) and "Operation Manual" before use.