

Made to Order Air Gripper

MH  *Series*

Made to Order Common Specifications



	Page
1-X4 Heat Resistance (-10 to 100 °C)	P.858
2-X5 Fluororubber Seal	P.859
3-X7 Closing Direction Spring Assist	P.860
4-X12 Opening Direction Spring Assist	P.862
5-X50 Without Magnet	P.864
6-X53 Ethylene Propylene Rubber Seal (EPDM)	P.865
7-X56 Axial Ported	P.866
8-X63 Fluorine Grease	P.869
9-X64 Finger: Side Tapped	P.870
10-X65 Finger: Through-holes in Opening/Closing Directions	P.872
11-X77 Dust Cover Adhesion	P.874
-X77A (Dust Cover Adhesion)	
-X77B (Dust Cover Adhesion/Finger Part Only)	
12-X78 Dust Cover Caulking	P.876
-X78A (Dust Cover Caulking)	
-X78B (Dust Cover Caulking/Finger Part Only)	
13-X79 Grease for Food Processing Machines/Fluorine Grease	P.878
14-X79A Grease for Food Processing Machines/ Aluminum Complex Soap Base Grease	P.879
15-X81 Anti-corrosive Treatment of Finger	P.880
-X81A (Special black chromium treatment is made on only the finger.)	
-X81B (Special black chromium treatment is made on the finger and guide.)	

Made to Order Common Specifications: Air Gripper -X4: Heat Resistance



1 Heat Resistance (-10 to 100°C)

Symbol

-X4

Seal material and grease have been changed, so that it could be used even at higher temperature up to 100 from -10°C.

Applicable Series

Series	Description	Model	Action	Note	Standard model page
MHC	Angular type	MHC2	Double acting, Single acting (Normally open)		P.807
		MHCA2	Double acting, Single acting (Normally open)	Magnet is not built-in.	P.796
		MHCM2	Single acting (Normally open)	Magnet is not built-in.	P.805
MHF	Low profile	MHF2	Double acting		P.560
MHK	Wedge cam operation slide guide	MHK2	Double acting, Single acting (Normally open, Normally closed)		P.676
		MHKL2	Double acting, Single acting (Normally open, Normally closed)		
MHL2	Wide type	MHL2-Z	Double acting		P.617
		MHL2	Double acting		P.639
MHS	2-finger type	MHS2	Double acting		P.702
	3-finger type	MHS3	Double acting		P.710
	3-finger type with dust cover	MHSJ3	Double acting		P.720
	With through hole	MHSH3	Double acting		P.728
	With through hole and dust cover	MHSHJ3	Double acting		
	Long stroke 3-finger type	MHSL3	Double acting		P.744
	4-finger type	MHS4	Double acting	Including MHT2-□DZ	P.754
MHT	Toggle type	MHT2	Double acting		P.818
MHW	180° angular type	MHW2	Double acting		P.843
MHY	180° angular type cam type	MHY2	Double acting	Magnet is not built-in.	P.836
		MHZ	MHZA2	Double acting, Single acting (Normally open, Normally closed)	Magnet is not built-in.
MHZAJ2	Double acting, Single acting (Normally open, Normally closed)				
MHZ2	Double acting, Single acting (Normally open, Normally closed)			P.496 to 498	
MHZL2	Double acting, Single acting (Normally open, Normally closed)			P.514	
	Parallel type with dust cover	MHZJ2	Double acting, Single acting (Normally open, Normally closed)		P.528

How to Order

Standard part number for each series **-X4**

Heat resistance ↓

Specifications

Ambient temperature range	-10°C to 100°C
Seal material	Fluororubber
Grease	Heat resistant grease (GR-F)
Specifications/dimensions other than the above	Same as the standard type

Note 1) Magnet is built-in, but when using an auto switch, the acceptable temperature range becomes -10 to 60 °C.

Note 2) With the part number for the dust cover option, only fluororubber (F) or silicone rubber (S) options may be selected.

Note 3) With the part number compatible with body options for MHZ series, only E type or M type are compatible.

Note 4) For lubrication, specialized grease GR-F is recommended.

Warning

Handling Precautions

Be aware that smoking cigarettes after your hands have come into contact with the grease used for this air gripper can create a gas that is hazardous to humans.

Replacement Parts: Seal Kit

Series	Model	Seal kit no.	Series	Model	Seal kit no.
MHC	MHC2-10 to 25	MHC□□-PS-X4	MHS	MHSH3	MHSH□□-PS-X4
	MHC2-6	Repaired or replaced by SMC.		MHSHJ3	MHSH□□A-PS-X4(For cylinder type center pusher)
	MHCA2	Repaired or replaced by SMC.		MHSL3	MHSL□□-PS-X4
	MHCM2	MHCM7-PS-X4		MHS4	MHS□□-PS-X4
MHF	MHF2	MHF□□-PS-X4	MHT	MHT2	CQ2B□□-XB6-PS
		MHF8-PS-2-X4 for only MHF2-8DS-X4	MHW	MHW2	MHW□□-PS-X4
MHK	MHK2	MHK□□-PS-X4	MHY	MHY2	MHY□□-PS-X4
	MHKL2	MHK□□-PS-X4		MHZ	MHZA2
MHL	MHL2-Z	MHL□□-PS-X4	MHZAJ2		Repaired or replaced by SMC.
	MHL2		MHZ2-6		Repaired or replaced by SMC.
MHS	MHS2	MHS□□-PS-X4	MHZ2		MHZ□□-PS-X4
	MHS3	MHS□□-PS-X4	MHZL2		MHZL□□-PS-X4
	MHSJ3	MHSJ□□-PS-X4	MHZJ2		MHZJ□□-PS-X4

Note 1) The cylinder bore size enters □□ of the seal kit no. Refer to the replacement parts of each model.

Note 2) The seal kit does not include grease. Please order the grease separately.

• Grease pack part no.: GR-F-005 (5 g)

Made to Order Common Specifications: Air Gripper -X5: Fluororubber Seal



2 Fluororubber Seal

Symbol
-X5

Applicable Series

Series	Description	Model	Action	Note	Standard model page
MHC	Angular type	MHC2	Double acting, Single acting (Normally open)		P.807
		MHCA2	Double acting, Single acting (Normally open)		P.796
		MHCM2	Single acting (Normally open)		P.805
MHF	Low profile	MHF2	Double acting		P.560
MHK	Wedge cam operation slide guide	MHK2	Double acting, Single acting (Normally open, Normally closed)	Dust cover material is fluororubber only.	P.676
		MHKL2	Double acting, Single acting (Normally open, Normally closed)	Dust cover material is fluororubber only.	
MHL2	Wide type	MHL2-Z	Double acting		P.617
		MHL2	Double acting		P.639
MHS	2-finger type	MHS2	Double acting		P.702
	3-finger type	MHS3	Double acting		P.710
	3-finger type with dust cover	MHSJ3	Double acting	Dust cover material is fluororubber only.	P.720
	With through hole	MHSH3	Double acting		P.728
	With through hole and dust cover	MHSHJ3	Double acting	Dust cover material is fluororubber only.	
	Long stroke 3-finger type	MHSL3	Double acting		P.744
MHT	Toggle type	MHT2	Double acting		P.754
		MHT2	Double acting	Including MHT2-□DZ	P.818
MHW	180° angular type	MHW2	Double acting		P.843
MHY	180° angular type cam type	MHY2	Double acting		P.836
MHZ	Parallel type (compact)	MHZA2	Double acting, Single acting (Normally open, Normally closed)		P.486
	Parallel type with dust cover (compact)	MHZAJ2	Double acting, Single acting (Normally open, Normally closed)	Dust cover material is fluororubber only.	
	Parallel type	MHZ2	Double acting, Single acting (Normally open, Normally closed)		P.496 to 498
	Parallel type (long stroke)	MHZL2	Double acting, Single acting (Normally open, Normally closed)		P.514
	Parallel type with dust cover	MHZJ2	Double acting, Single acting (Normally open, Normally closed)	Dust cover material is fluororubber only.	P.528

How to Order

Standard part number for each series **-X5**

Fluororubber Seal

- Note 1) Please contact SMC, since the type of chemical and the operating temperature may not allow the use of this product.
- Note 2) Since the standard-type magnet is built-in, please contact SMC for the product's adaptability to the operating environment.
- Note 3) For the air gripper with a dust cover, the dust cover material is also fluororubber. Thus, enter (F) for the fluororubber dust cover in the part number.
- Note 4) With the part number compatible with body options for the MHZ series, only E type or M type are compatible.

Specifications

Seal material	Fluororubber
Specifications/dimensions other than the above	Same as the standard type of each series

Replacement Parts: Seal Kit

Series	Model	Seal kit no.	Series	Model	Seal kit no.
MHC	MHC2-10 to 25	MHC□□-PS-X4	MHS	MHS3	MHS□□-PS-X4
	MHC2-6	Repaired or replaced by SMC.		MHSHJ3	MHSH□□A-PS-X4(For cylinder type center pusher)
	MHCA2	Repaired or replaced by SMC.		MHSL3	MHSL□□-PS-X4
	MHCM2	MHCM7-PS-X4		MHS4	MHS□□-PS-X4
MHF	MHF2	MHF□□-PS-X4	MHT	MHT2	CQ2B□□-XB6-PS
		MHF8-PS-2-X4 for only MHF2-8DS-X4	MHW	MHW2	MHW□□-PS-X4
MHK	MHK2	MHK□□-PS-X4	MHY	MHY2	MHY□□-PS-X4
	MHKL2	MHKL□□-PS-X4	MHZ	MHZA2	Repaired or replaced by SMC.
MHL	MHL2-Z	MHL□□-PS-X4		MHZAJ2	Repaired or replaced by SMC.
	MHL2	MHL□□-PS-X4		MHZ2-6	Repaired or replaced by SMC.
MHS	MHS2	MHS□□-PS-X4		MHZ2	MHZ□□-PS-X4
	MHS3	MHS□□-PS-X4		MHZL2	MHZL□□-PS-X4
	MHSJ3	MHSJ□□-PS-X4	MHZJ2	MHZJ□□-PS-X4	

- Note 1) The cylinder bore size enters □□ of the seal kit no. Refer to the replacement parts of each model.
- Note 2) The seal kit does not include grease. Please order the grease separately.
- Refer to the "Replacement Parts" section of the standard type for the grease pack part number.

Made to Order Common Specifications: Air Gripper -X7: Closing Direction Spring Assist



Symbol

-X7

3 Closing Direction Spring Assist

When gripping the exterior of the workpiece, this assists to hold the workpiece in place even when there is no supply of compressed air.

Applicable Series

Series	Description	Model	Action	Note	Standard model page
MHK	Wedge cam operation glide guide	MHK2	Double acting		P.676
		MHKL2	Double acting		
MHZ	Parallel type	MHZ2	Double acting		P.496 to 498
	Parallel type (long stroke)	MHZL2	Double acting		P.514
	Parallel type with dust cover	MHZJ2	Double acting		P.528

How to Order

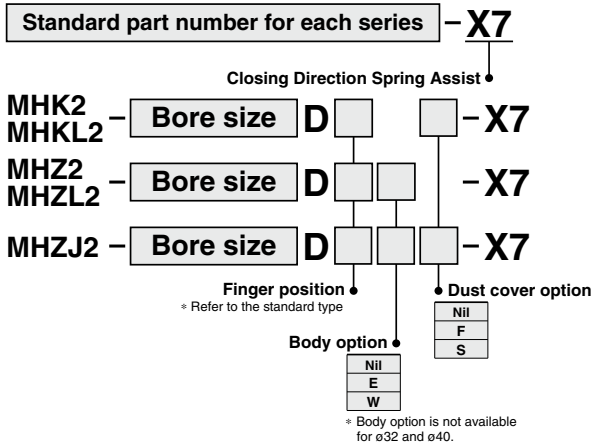

Note 1) Operating pressure is different from that of the standard double acting type. (Refer to the table below.)

Note 2) For the body options of MHZ2, MHZJ2 and MHZL2 ø10 to ø25, only E type or W type are compatible.

Note 3) Dimensions of MHZ2-32D/-40D and MHZL2 are the same as the single acting type.

Note 4) For internal grip, the gripping point range limit is the same as the standard type.

Specifications

MHK□2

Bore size (mm)		12	16	20	25
Operating pressure (MPa)		0.25 to 0.5			
Gripping Point Range Limit (External grip)		Refer to the graphs.			
MHK2	Weight (g)	76	114	237	443
	External grip	18.5	41	57	91.5
MHKL2	Weight (g)	105	165	314	565
	External grip	18.5	34	56.5	103

* Gripping force is measured at a pressure of 0.5 MPa, gripping point L = 20 mm, center of stroke.

MHZ□2

Bore size (mm)		6	10	16	20	25	32	40
Operating pressure (MPa)		0.3 to 0.6	0.35 to 0.6	0.25 to 0.6				
Gripping Point Range Limit (External grip)		Refer to the graphs.						
MHZ2	Weight (g)	27	55	115	240	435	760	1370
	External grip	5.5	14.5	40	50	84	187	300
MHZL2	Weight (g)	-	70	140	290	515	-	-
	External grip	-	14.5	40.5	50	82	-	-
MHZJ2	Weight (g)	28	60	130	255	465	-	-
	External grip	5.5	14.5	38	51	84	-	-

* MHZL2 series ø32 and ø40 have the same dimensions as the single acting type.

* Gripping force is measured at a pressure of 0.5 MPa, gripping point L = 20 mm, center of stroke.

3 Closing Direction Spring Assist

Gripping Point Range Limit

MHZ **2 Series**

MHZ **2-6D** **-X7**

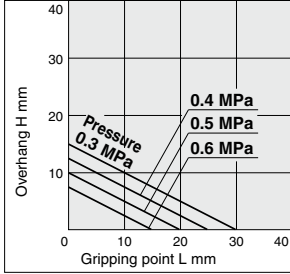

MHZ **2-25D** **-X7**

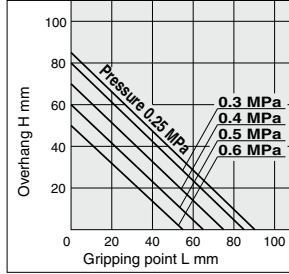

MHK **2 Series**

MHK **2-12D** **-X7**

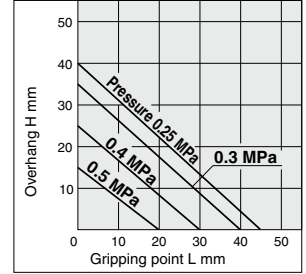

MHZ **2-10D** **-X7**

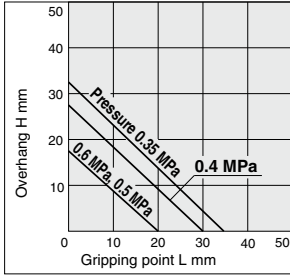

MHZ **2-32D** **-X7**

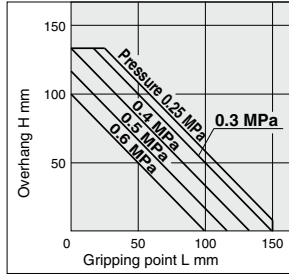

MHK **2-16D** **-X7**

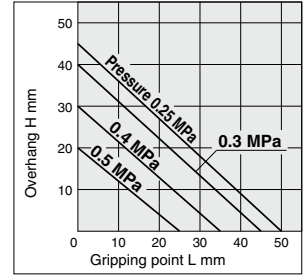

MHZ **2-16D** **-X7**

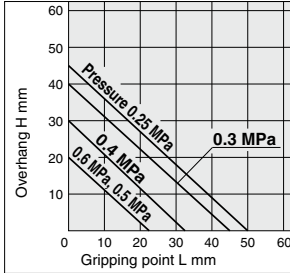

MHZ **2-40D** **-X7**

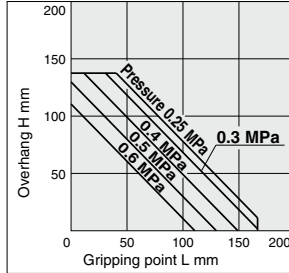

MHK **2-20D** **-X7**

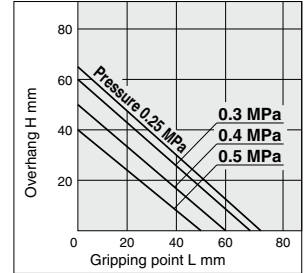

MHZ **2-20D** **-X7**

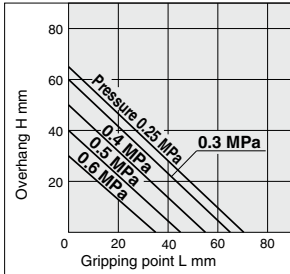

MHK **2-25D** **-X7**

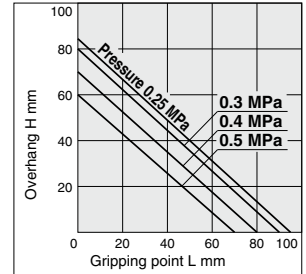

Made to Order Common Specifications: Air Gripper -X12: Opening Direction Spring Assist



4 Opening Direction Spring Assist

Symbol
-X12

When gripping the interior of the workpiece, this assists to hold the workpiece in place even when there is no supply of compressed air.

Applicable Series

Series	Description	Model	Action	Note	Standard model page
MHK	Wedge cam operation glide guide	MHK2	Double acting		P.676
		MHKL2	Double acting		
MHZ	Parallel type (compact)	MHZA2	Double acting		P.486
	Parallel type with dust cover (compact)	MHZAJ2	Double acting		
	Parallel type	MHZ2	Double acting		P.496 to 498
	Parallel type (long stroke)	MHZL2	Double acting		P.514
	Parallel type with dust cover	MHZJ2	Double acting		P.528

How to Order

Standard part number for each series **-X12**

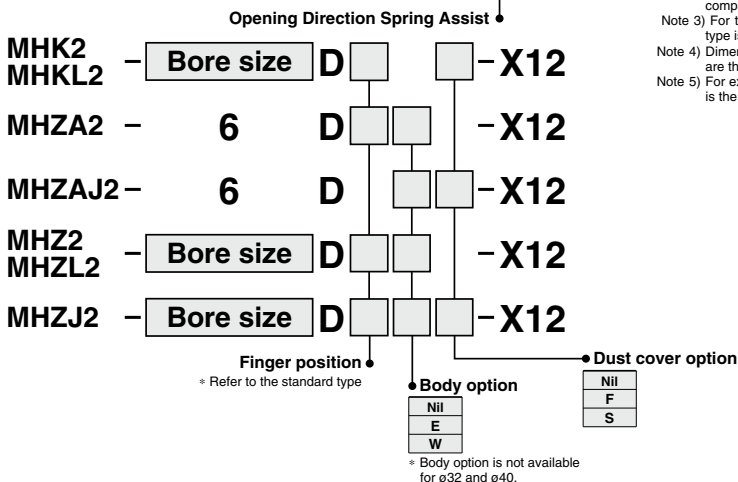

Note 1) Operating pressure is different from that of the standard double acting type. (Refer to the table below.)

Note 2) For the body options of MHZ2, MHZJ2 and MHZL2 ø10 to ø25, only E type or W type are compatible.

Note 3) For the body option of MHZA(J)2-6D, only E type is compatible.

Note 4) Dimensions of MHZ2-32D/40D and MHZL2 are the same as the single acting type.

Note 5) For external grip, the gripping point range limit is the same as the standard type.

Specifications

MHK□2

Bore size (mm)		12	16	20	25
Operating pressure (MPa)		0.25 to 0.5			
Gripping Point Range Limit (Internal grip)		Refer to the graphs.			
MHK2	Weight (g)	76	114	237	443
	Internal gripping force (N)	21.5	43	67	106
MHKL2	Weight (g)	105	165	314	565
	Internal gripping force (N)	20.5	39	64.5	113.5

* Gripping force is measured at a pressure of 0.5 MPa, gripping point L = 20 mm, center of stroke.

MHZ□2

Bore size (mm)		6	10	16	20	25	32	40
Operating pressure (MPa)		0.3 to 0.6	0.35 to 0.6	0.25 to 0.6				
Gripping Point Range Limit (Internal grip)		Refer to the graphs.						
MHZA2	Weight (g)	26	-	-	-	-	-	-
	Internal gripping force (N)	7.3	-	-	-	-	-	-
MHZAJ2	Weight (g)	27	-	-	-	-	-	-
	Internal gripping force (N)	7.3	-	-	-	-	-	-
MHZ2	Weight (g)	27	55	115	240	435	760	1370
	Internal gripping force (N)	7.3	20.5	51.5	74	122	217.5	351.5
MHZL2	Weight (g)	-	70	140	290	515	-	-
	Internal gripping force (N)	-	20.5	51.5	74	117.5	-	-
MHZJ2	Weight (g)	28	60	130	255	465	-	-
	Internal gripping force (N)	7.3	20	45.5	78.5	122	-	-

* MHZL2 series ø32 and ø40 have the same dimensions as the single acting type.

* Gripping force is measured at a pressure of 0.5 MPa, gripping point L = 20 mm, center of stroke.

4 Opening Direction Spring Assist

Gripping Point Range Limit

MHZ **2 Series**

MHZ **2-6D** **-X12**

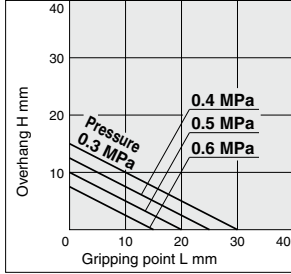

MHZ **2-25D** **-X12**

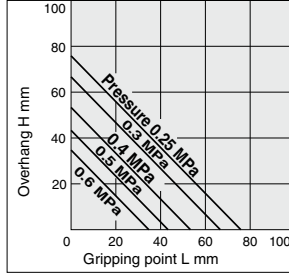

MHK **2 Series**

MHK **2-12D** **-X12**

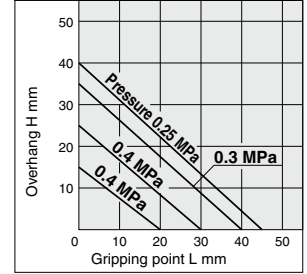

MHZ **2-10D** **-X12**

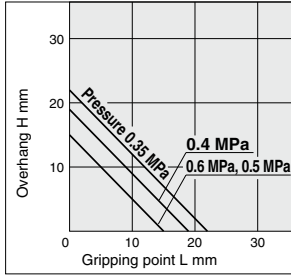

MHZ **2-32D** **-X12**

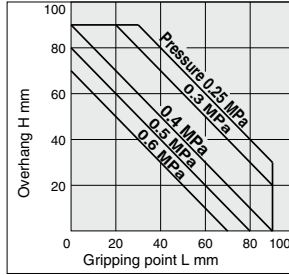

MHK **2-16D** **-X12**

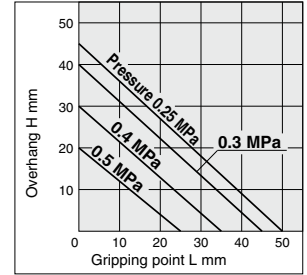

MHZ **2-16D** **-X12**

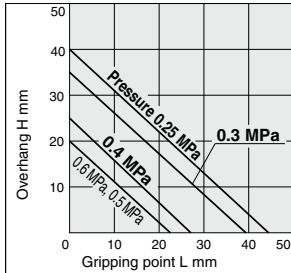

MHZ **2-40D** **-X12**

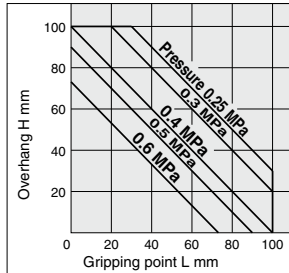

MHK **2-20D** **-X12**

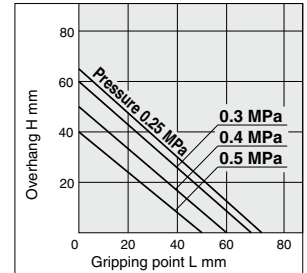

MHZ **2-20D** **-X12**

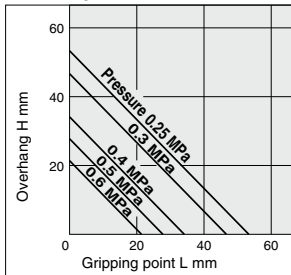

MHK **2-25D** **-X12**

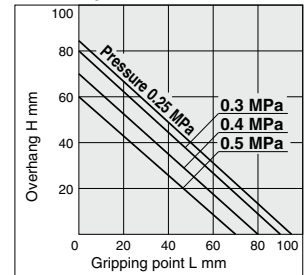

Made to Order Common Specifications: Air Gripper -X50: Without Magnet



5 Without Magnet

Symbol
-X50

Applicable Series

Series	Description	Model	Action	Note	Standard model page
MHC	Angular type	MHC2	Double acting, Single acting (Normally open)		P.807
MHF	Low profile	MHF2	Double acting	Note 3)	P.560
MHK	Wedge cam operation slide guide	MHK2	Double acting, Single acting (Normally open, Normally closed)		P.676
		MHKL2	Double acting, Single acting (Normally open, Normally closed)		
MHL2	Wide type	MHL2-Z	Double acting		P.617
		MHL2	Double acting		P.639
MHS	2-finger type	MHS2	Double acting		P.702
	3-finger type	MHS3	Double acting		P.710
	3-finger type with dust cover	MHSJ3	Double acting		P.728
	With through hole	MHSH3	Double acting		
	With through hole and dust cover	MHSHJ3	Double acting		P.744
	Long stroke 3-finger type	MHSL3	Double acting		P.754
4-finger type	MHS4	Double acting		P.818	
MHT	Toggle type	MHT2	Double acting		P.843
MHW	180° angular type	MHW2	Double acting		P.836
MHY	180° angular type cam type	MHY2	Double acting		P.456
JMHZ2	Compact type parallel style air gripper	JMHZ2	Double acting, Single acting (Normally open, Normally closed)		P.496 to 498
		MHZ2	Double acting, Single acting (Normally open, Normally closed)	Note 4)	
MHZ	Parallel type	MHZL2	Double acting, Single acting (Normally open, Normally closed)		P.514
	Parallel type (long stroke)	MHZL2	Double acting, Single acting (Normally open, Normally closed)		P.528
	Parallel type with dust cover	MHZJ2	Double acting, Single acting (Normally open, Normally closed)	Note 5)	

How to Order

Standard part number for each series **-X50**

Without Magnet

- Note 1) No symbol is specified for a product without a magnet as standard.
- Note 2) MDHR series comes with a magnet. Please use the MHR series when a product without a magnet is needed.
- Note 3) MHC2-6 is not applicable. Please use the MHCA2-6.
- Note 4) MHZ2-6 is not applicable. Please use the MHZA2-6.
- Note 5) MHZJ2-6 is not applicable. Please use the MHZAJ2-6.

Specifications

Same as the standard type of each series
Auto switches cannot be used.

Replacement Parts: MHT2 Cylinder Part Nos.

Replacement Parts

Description	MHT2-32□□DZ-X50	MHT2-40□□DZ-X50	MHT2-50□□DZ-X50	MHT2-63□□DZ-X50	Note
Compact cylinder	CQ2A32-15DZ	CQ2A40-15DZ	CQ2A50-20DZ	CQ2A63-20DZ	MHT2-□□DZ-X50
	CQ2A32TN-15DZ	CQ2A40TN-15DZ	CQ2A50TN-20DZ	CQ2A63TN-20DZ	MHT2-□□TNDZ-X50
	CQ2A32TF-15DZ	CQ2A40TF-15DZ	CQ2A50TF-20DZ	CQ2A63TF-20DZ	MHT2-□□TFDZ-X50

5 Without Magnet

Dimensions (Dimensions other than specified below are the same as the standard type.)

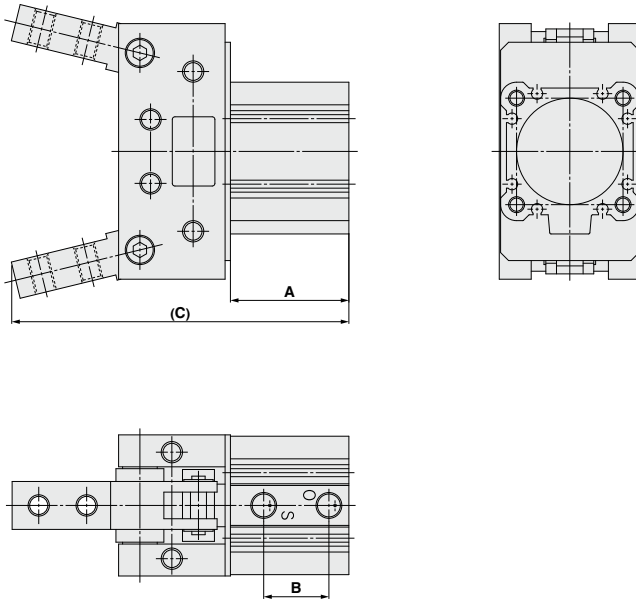

(mm)

Model	A	B	(C)	Weight (g)
MHT2-32 <input type="checkbox"/> DZ-X50	38	20.5	(113.6)	735
MHT2-40 <input type="checkbox"/> DZ-X50	44.5	24.5	(126.5)	990
MHT2-50 <input type="checkbox"/> DZ-X50	50.5	29.5	(147)	1775
MHT2-63 <input type="checkbox"/> DZ-X50	56	30.5	(159.2)	2575



Made to Order Common Specifications: Air Gripper -X53: Ethylene Propylene Rubber Seal (EPDM)

6 Ethylene Propylene Rubber Seal

Symbol

-X53

Seal material has been changed to ethylene propylene (EPDM), and grease to fluorine grease.

Applicable Series

Series	Description	Model	Action	Note	Standard model page
MHC	Angular type	MHC2	Double acting, Single acting (Normally open)		P.807
		MHCA2	Double acting, Single acting (Normally open)		P.796
MHF	Low profile	MHF2	Double acting		P.560
MHK	Wedge cam operation slide guide	MHK2	Double acting, Single acting (Normally open, Normally closed)	Dust cover material is EPDM only.	P.676
		MHKL2	Double acting, Single acting (Normally open, Normally closed)	Dust cover material is EPDM only.	
MHL2	Wide type	MHL2-Z	Double acting		P.617
		MHL2	Double acting		P.639
MHS	2-finger type	MHS2	Double acting		P.702
	3-finger type	MHS3	Double acting		P.710
	3-finger type with dust cover	MHSJ3	Double acting	Dust cover material is EPDM only.	P.728
	With through hole	MHSH3	Double acting		
	With through hole and dust cover	MHSHJ3	Double acting	Dust cover material is EPDM only.	P.744
	Long stroke 3-finger type	MHSL3	Double acting		P.754
MHW	180° angular type	MHW2	Double acting		P.843
MHY	180° angular type cam type	MHY2	Double acting		P.836
MHZ	Parallel type (compact)	MHZA2	Double acting, Single acting (Normally open, Normally closed)		P.486
	Parallel type with dust cover (compact)	MHZAJ2	Double acting, Single acting (Normally open, Normally closed)	Dust cover material is EPDM only.	
	Parallel type	MHZ2	Double acting, Single acting (Normally open, Normally closed)		P.496 to 498
	Parallel type (long stroke)	MHZL2	Double acting, Single acting (Normally open, Normally closed)		P.514
	Parallel type with dust cover	MHZJ2	Double acting, Single acting (Normally open, Normally closed)	Dust cover material is EPDM only.	P.528

How to Order

Standard part number for each series – **X53**

Ethylene Propylene Rubber Seal (EPDM)

Note 1) For the product with a dust cover, dust cover material is also ethylene propylene rubber. Thus, enter no symbol for the dust cover in the part number.

Note 2) With the part number compatible with body options, only E type or M type are compatible.

Note 3) For lubrication, specialized grease GR-F is recommended.

Specifications

Seal material	Ethylene propylene rubber (EPDM)
Grease	Fluorine grease (GR-F)
Specifications/dimensions other than the above	Same as the standard type for each series

Warning

Handling Precautions

Be aware that smoking cigarettes after your hands have come into contact with the grease used for this air gripper can create a gas that is hazardous to humans.

Made to Order Common Specifications: Air Gripper -X56: Axial Ported



7 Axial Ported

Symbol
-X56

Applicable Series

Series	Description	Model	Action	Note	Standard model page	
MHC	Angular type	MHC2	Double acting, Single acting (Normally open)	ø10, 16, 20, 25 only	P.807	
		MHCA2	Double acting, Single acting (Normally open)		P.796	
		MHCM2	Single acting (Normally open)		P.805	
MHS	2-finger type	MHS2	Double acting	ø16, 20, 25, 32, 40, 50, 63 only	P.702	
	3-finger type	MHS3	Double acting		P.710	
	3-finger type with dust cover	MHSJ3	Double acting		P.720	
	With through hole	MHSH3	Double acting		Center pusher type is not compatible.	P.728
	With through hole and dust cover	MHSHJ3	Double acting			
	Long stroke 3-finger type	MHSL3	Double acting		ø16, 20, 25, 32, 40, 50, 63 only	P.744
	4-finger type	MHS4	Double acting			P.754
MHZ	Parallel type (compact)	MHZA2	Double acting, Single acting (Normally open, Normally closed)	ø10, 16, 20, 25 only	P.486	
	Parallel type with dust cover (compact)	MHZAJ2	Double acting, Single acting (Normally open, Normally closed)			
	Parallel type	MHZ2	Double acting, Single acting (Normally open, Normally closed)		P.497	
	Parallel type (long stroke)	MHZL2	Double acting, Single acting (Normally open, Normally closed)		P.514	
	Parallel type with dust cover	MHZJ2	Double acting, Single acting (Normally open, Normally closed)		ø10, 16, 20, 25 only	P.528

How to Order

Standard part number for each series **-X56**

Axial Ported

Note 1) Body option is not compatible.

Note 2) MHS3 and MHSHJ3 series (center pusher type) are not compatible.

Dimensions (Dimensions other than specified below are the same as the standard type.)

(mm)

MHCA2-6 Series

MHZA2-6 Series

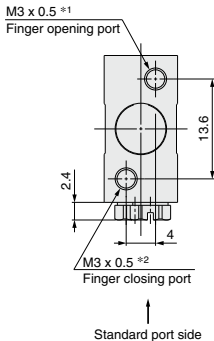

MHCA2 Series

*1) Single acting (normally open) type is not available with a finger opening port. Standard opening port will be a breathing hole.

MHZA2, MHZAJ2 Series

*1) Normally open type is not available with a finger opening port. Standard opening port will be a breathing hole.

*2) Normally closed type is not available with a finger closing port. Standard closing port will be a breathing hole.

Note 1) Standard port is blocked with a M-3P plug. M-3P plug is not interchangeable with a hexagon socket head set screw.
Note 2) This cannot be mounted from top side.

MHCM2-7S Series

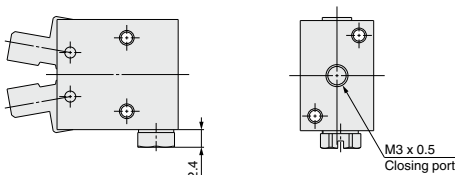

Note 1) Standard port is blocked with a M-3P plug.

7 Axial Ported

Symbol
-X56

Dimensions (Dimensions other than specified below are the same as the standard type.)

MHC2 Series
MHZ2 Series
MHZL2 Series
MHZJ2 Series

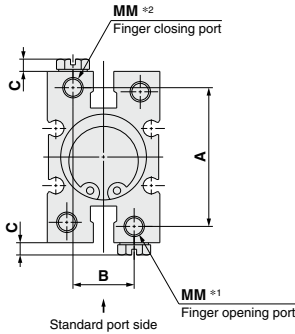

(MHC2 has different switch groove.)

MHC2 Series (mm)

Model	A	B	C	MM
MHC2-10□-X56	13	11	2.4	M3 x 0.5
MHC2-16□-X56	22.6	13	3	M3 x 0.5
MHC2-20□-X56	34	15	3	M5 x 0.8
MHC2-25□-X56	44	20	3	M5 x 0.8

*1) For the single acting type, a standard port does not include a plug and will be a breathing hole.

For the single acting type, axial opening ports are not available.

Note 1) Switch groove and standard port positions are different for each model.

Note 2) Standard port is blocked with a M-3P or M-5P plug.

MHZ2 Series (mm)

Model	A	B	C	MM
MHZ2-10□□-X56	13	11	2.4	M3 x 0.5
MHZ2-16□□-X56	22	15	3	M3 x 0.5
MHZ2-20□□-X56	34	15	3	M5 x 0.8
MHZ2-25□□-X56	44	20	3	M5 x 0.8

MHZL2 Series (mm)

Model	A	B	C	MM
MHZL2-10□□-X56	13	11	2.4	M3 x 0.5
MHZL2-16□□-X56	22.6	13	3	M3 x 0.5
MHZL2-20□□-X56	34	15	3	M5 x 0.8
MHZL2-25□□-X56	44	20	3	M5 x 0.8

MHZJ2 Series (mm)

Model	A	B	C	MM
MHZJ2-10□□-X56	13	11	2.4	M3 x 0.5
MHZJ2-16□□-X56	22.6	13	3	M3 x 0.5
MHZJ2-20□□-X56	34	15	3	M5 x 0.8
MHZJ2-25□□-X56	44	20	3	M5 x 0.8

*1) For the single acting type, the port on one side becomes the breathing hole.

Note 1) Please contact SMC for bore sizes ø32 and ø40 of the MHZ2 series.

Note 2) A plug is located at the same position for the end boss type.

Note 3) Bore size ø6 of the MHZ2 and MHZJ2 series is not compatible.

7 Axial Ported

Symbol
-X56

Dimensions (Dimensions other than specified below are the same as the standard type.)

MHS₄ Series

ø16 to ø25

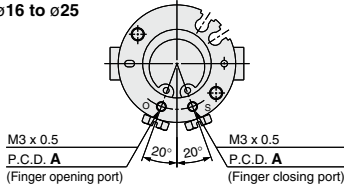

(mm)	
Model	A
MHS ₄ ² -16D-X56	23
MHS ₄ ² -20D-X56	27
MHS ₄ ² -25D-X56	32

ø32 to ø63

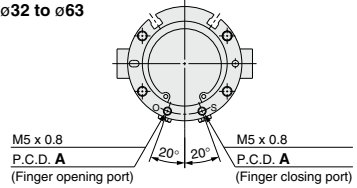

(mm)	
Model	A
MHS ₄ ² -32D-X56	44
MHS ₄ ² -40D-X56	52
MHS ₄ ² -50D-X56	62
MHS ₄ ² -63D-X56	75

MHS₃ Series

ø16 to ø25

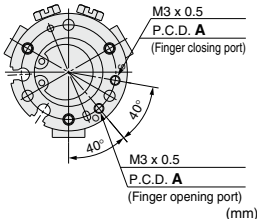

(mm)	
Model	A
MHS ₃ ³ -16D-X56	23
MHS ₃ ³ -20D-X56	28
MHS ₃ ³ -25D-X56	34

ø32 to ø50

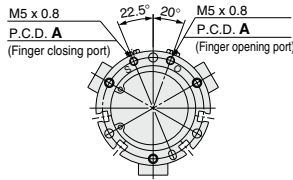

(mm)	
Model	A
MHS ₃ ³ -32D-X56	44
MHS ₃ ³ -40D-X56	53
MHS ₃ ³ -50D-X56	62

ø63

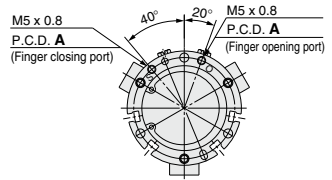

(mm)	
Model	A
MHS ₃ ³ -63D-X56	75

MHSH3 Series

MHS_{H3} Series

ø16 to ø80

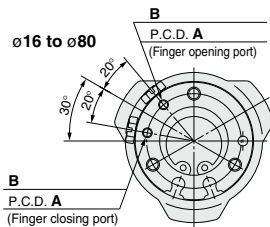

(mm)		
Model	A	B
MHSH3-16D-X56	23	M3 x 0.5
MHSH3-16D□-X56		
MHSH3-20D-X56	27	
MHSH3-20D□-X56		
MHSH3-25D-X56	32	M5 x 0.8
MHSH3-25D□-X56		
MHSH3-32D-X56	44	
MHSH _{H3} ³ -32D□-X56		
MHSH3-40D-X56	52	
MHSH _{H3} ³ -40D□-X56		
MHSH3-50D-X56	63	
MHSH _{H3} ³ -50D□-X56		
MHSH3-63D-X56	78	
MHSH _{H3} ³ -63D□-X56		
MHSH3-80D-X56	94	
MHSH _{H3} ³ -80D□-X56		

Note 1) Standard side piping ports are blocked with the following plugs.
ø16: M-3P plug
ø20 to ø63: M-5P plug

Note 2) For the MHS3 and MHSL3 series, a piping port cannot be used depending on the port size since the port is located close to a positioning pin hole or long hole, or just above the pin hole.

Note 3) Please contact SMC separately for bore sizes ø80, ø100 and ø125 of the MHS3 and MHSL3 series.

Made to Order Common Specifications: Air Gripper -X63: Fluorine Grease



8 Fluoro Grease

Symbol
-X63

Applicable Series

Series	Description	Model	Action	Note	Standard model page
MHC	Angular type	MHC2	Double acting, Single acting (Normally open)		P.807
		MHCA2	Double acting, Single acting (Normally open)		P.796
		MHCM2	Single acting (Normally open)		P.805
MHF	Low profile	MHF2	Double acting		P.560
MHK	Wedge cam operation slide guide	MHK2	Double acting, Single acting (Normally open, Normally closed)		P.676
		MHKL2	Double acting, Single acting (Normally open, Normally closed)		
MHL2	Wide type	MHL2-Z	Double acting		P.617
		MHL2	Double acting		P.639
		MHR2	Double acting		
MHR	Rotary actuator	MDHR2	Double acting		P.643
		MHR3	Double acting		
		MDHR3	Double acting		
					P.656
MHS	2-finger type	MHS2	Double acting		P.702
	3-finger type	MHS3	Double acting		P.710
	3-finger type with dust cover	MHSJ3	Double acting		P.720
	With through hole	MHSH3	Double acting		
	With through hole and dust cover	MHSHJ3	Double acting		P.728
	Long stroke 3-finger type	MHSL3	Double acting		P.744
MHT	Toggle type	MHT2	Double acting	Including MHT2-□DZ	P.818
MHW	180° angular type	MHW2	Double acting		P.843
MHY	180° angular type cam type	MHY2	Double acting		P.836
MHZ	Parallel type (compact)	MHZA2	Double acting, Single acting (Normally open, Normally closed)		
	Parallel type with dust cover (compact)	MHZAJ2	Double acting, Single acting (Normally open, Normally closed)		P.486
	Parallel type	MHZ2	Double acting, Single acting (Normally open, Normally closed)		
	Parallel type (long stroke)	MHZL2	Double acting, Single acting (Normally open, Normally closed)		P.514
	Parallel type with dust cover	MHZJ2	Double acting, Single acting (Normally open, Normally closed)		P.528

How to Order

Standard part number for each series **-X63**
Fluorine Grease

Note) For lubrication, specialized grease GR-F is recommended.

Specifications

Grease	Fluorine grease (GR-F)
Specifications/dimensions other than the above	Same as the standard type for each series

Warning

Handling Precautions

Be aware that smoking cigarettes after your hands have come into contact with the grease used for this air gripper can create a gas that is hazardous to humans.

Made to Order Common Specifications: Air Gripper -X64: Finger: Side Tapped



9 Finger: Side Tapped

Symbol
-X64

Attachments can be mounted even on models without a finger option (side tapped mounting) using a tap on the side.

Applicable Series

Series	Description	Model	Action	Note	Standard model page
MHC	Angular type	MHC2	Double acting, Single acting (Normally open)		P.807
		MHCA2	Double acting, Single acting (Normally open)		P.796
MHK	Wedge cam operation slide guide	MHK2	Double acting, Single acting (Normally open, Normally closed)	Refer to Note 5).	P.676
		MHKL2	Double acting, Single acting (Normally open, Normally closed)		
MHZ	Parallel type with dust cover (compact)	MHZAJ2	Double acting, Single acting (Normally open, Normally closed)		P.486
	Parallel type with dust cover	MHZJ2	Double acting, Single acting (Normally open, Normally closed)		P.528

How to Order

MHCA2 - 6 [] 1 [] - X64

MHC2 - Bore size [] 1 [] - X64

MHZAJ2 - 6 [] 1 [] [] - X64

MHZJ2 - 6 [] 1 [] - X64

MHZJ2 - Bore size [] 1 [] [] - X64

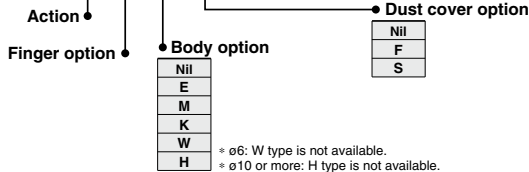

Note 1) Refer to the standard type for the details of body option and dust cover option.

Note 2) Finger option: "1" fixed

Note 3) Since the MHC2 series is a modified version of the standard type and not retreated, modified parts may rust.

Dimensions (Dimensions other than specified below are the same as the standard type.)

MHCA2 Series MHC2 Series

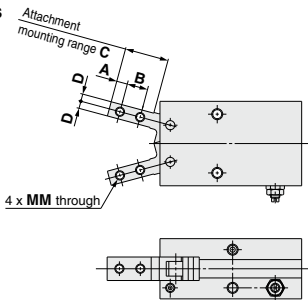

MHZAJ2 Series MHZJ2 Series

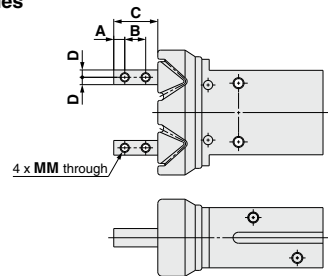

Model	A	B	C	D	MM
MHCA2-6□1□-X64	2.5	5	11	2	M2 x 0.4
MHC2-6□1-X64	2.5	5	11	2	M2 x 0.4
MHC2-10□1-X64	3	5.7	12	2	M2.5 x 0.45
MHC2-16□1-X64	4	7	16	3.5	M3 x 0.5
MHC2-20□1-X64	5.2	9	20	4	M4 x 0.7
MHC2-25□1-X64	8	12	27	5	M5 x 0.8

Model	A	B	C	D	MM
MHZAJ2-6□1□-X64	2.5	5	11	2	M2 x 0.4
MHZJ2-6□1□-X64	2.5	5	11	2	M2 x 0.4
MHZJ2-10□1□-X64	3	5.7	12	2	M2.5 x 0.45
MHZJ2-16□1□-X64	4	7	15	2.5	M3 x 0.5
MHZJ2-20□1□-X64	5	9	20	4	M4 x 0.7
MHZJ2-25□1□-X64	6	12	25	5	M5 x 0.8

9 Finger: Side Tapped

How to Order

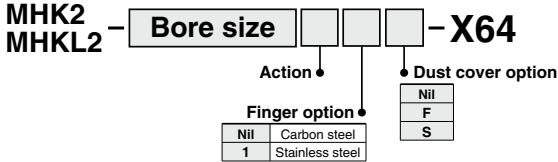

* When 1 is entered for finger option, it means that finger is made of stainless steel.

Note 4) Refer to the standard type for the details of the dust cover option.

Note 5) For only the MHK2 and MHKL2 series, finger option "1" means a stainless steel finger.

Note 6) Since the MHK(L)2 series is additionally modified as a side tapped and not treated, it may rust when the standard finger is used.

Dimensions (Dimensions other than specified below are the same as the standard type.)

MHK2 Series

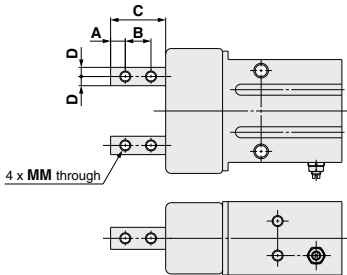

MHKL2 Series

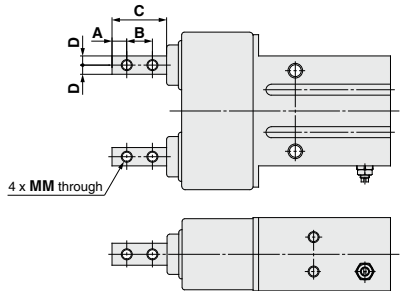

(mm)

Model	A	B	C	D	MM
MHK2-12□□□-X64	4	7	15	2.5	M3 x 0.5
MHKL2-12□□□-X64	4	7	15	2.5	M3 x 0.5
MHK2-16□□□-X64	4	7	15	2.5	M3 x 0.5
MHKL2-16□□□-X64	4	7	15	2.5	M3 x 0.5
MHK2-20□□□-X64	5	9	21	4	M4 x 0.7
MHKL2-20□□□-X64			20		
MHK2-25□□□-X64	6	12	26	5	M5 x 0.8
MHKL2-25□□□-X64			25		

* For ø12, the standard screw is not threaded.



Made to Order Common Specifications: Air Gripper -X65: Finger: Through-holes in Opening/Closing Direction

10 Finger: Through-holes in Opening/Closing Direction Symbol **-X65**

Even for models without a finger option (through-holes in opening/closing directions) setting, attachments are mountable using through-holes in opening and closing directions.

Applicable Series

Series	Description	Model	Action	Note	Standard model page
MHC	Angular type	MHC2	Double acting, Single acting (Normally open)		P.807
		MHCA2	Double acting, Single acting (Normally open)		P.796
MHK	Wedge cam operation slide guide	MHK2	Double acting, Single acting (Normally open, Normally closed)	Refer to Note 5).	P.676
		MHKL2	Double acting, Single acting (Normally open, Normally closed)		
MHZ	Parallel type with dust cover (compact)	MHZA2	Double acting, Single acting (Normally open, Normally closed)		P.486
	Parallel type with dust cover	MHZJ2	Double acting, Single acting (Normally open, Normally closed)		P.528

How to Order

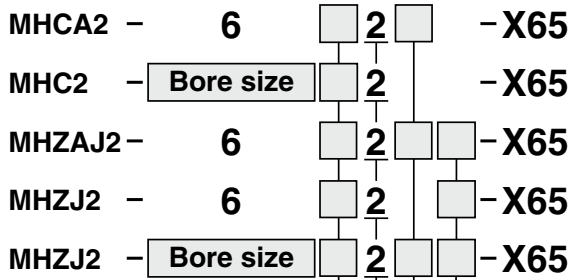

- Note 1) Refer to the standard type for the details of body option and dust cover option.
- Note 2) Finger option: "2" fixed
- Note 3) Since the MHC2 series is a modified version of the standard type and not retreated, modified parts may rust.

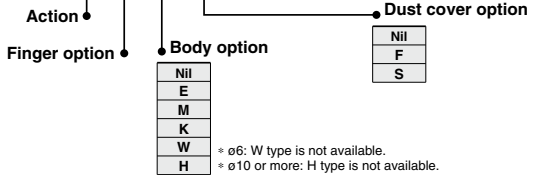

Dimensions (Dimensions other than specified below are the same as the standard type.)

MHCA2 Series MHC2 Series

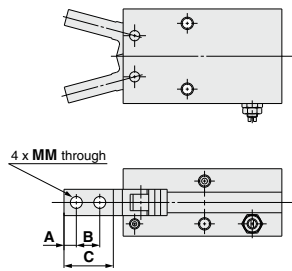

MHZA2 Series MHZJ2 Series

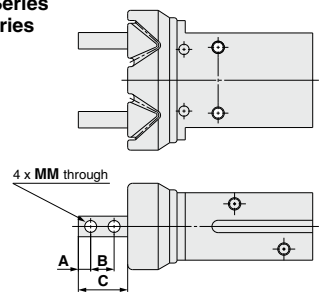

Model	A	B	C	MM
MHCA2-6 2 -X65	2.5	5	11	ø2.4
MHC2-6 2 -X65	2.5	5	11	ø2.4
MHC2-10 2 -X65	3	5.7	12	ø2.9
MHC2-16 2 -X65	4	7	16	ø3.4
MHC2-20 2 -X65	5.2	9	20	ø4.5
MHC2-25 2 -X65	8	12	27	ø5.5

Model	A	B	C	MM
MHZA2-6 2 -X65	2.5	5	11	ø2.4
MHZJ2-6 2 -X65	2.5	5	11	ø2.4
MHZJ2-10 2 -X65	3	5.7	12	ø2.9
MHZJ2-16 2 -X65	4	7	15	ø3.4
MHZJ2-20 2 -X65	5	9	20	ø4.5
MHZJ2-25 2 -X65	6	12	25	ø5.5



10 Finger: Through-holes in Opening/Closing Direction

Symbol
-X65

How to Order

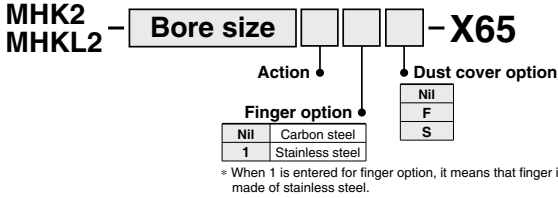

Note 4) Refer to the standard type for the details of the dust cover option.

Note 5) For only the MHK2 and MHKL2 series, finger option "2" means a stainless steel finger. For other models, finger option "2" is not applicable.

Note 6) Since the MHK(L)2 series is additionally modified with through-holes in opening/closing directions and is not treated, it may rust when the standard finger is used.

Dimensions (Dimensions other than specified below are the same as the standard type.)

MHK2 Series

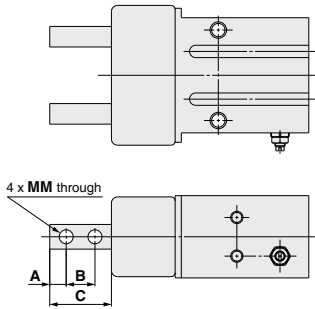

MHKL2 Series

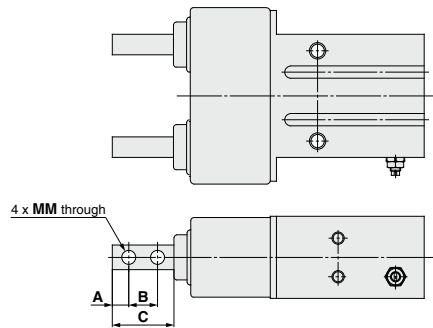

(mm)

Model	A	B	C	MM
MHK2-12 <input type="checkbox"/> <input type="checkbox"/> <input type="checkbox"/> -X65	4	7	15	ø3.4
MHKL2-12 <input type="checkbox"/> <input type="checkbox"/> <input type="checkbox"/> -X65				
MHK2-16 <input type="checkbox"/> <input type="checkbox"/> <input type="checkbox"/> -X65	4	7	15	ø3.4
MHKL2-16 <input type="checkbox"/> <input type="checkbox"/> <input type="checkbox"/> -X65				
MHK2-20 <input type="checkbox"/> <input type="checkbox"/> <input type="checkbox"/> -X65	5	9	21	ø4.5
MHKL2-20 <input type="checkbox"/> <input type="checkbox"/> <input type="checkbox"/> -X65			20	
MHK2-25 <input type="checkbox"/> <input type="checkbox"/> <input type="checkbox"/> -X65	6	12	26	ø5.5
MHKL2-25 <input type="checkbox"/> <input type="checkbox"/> <input type="checkbox"/> -X65			25	

Made to Order Common Specifications: Air Gripper -X77^A_B: Dust Cover Adhesion



11 Dust Cover Adhesion (Powerful adhesive used)

Symbol
-X77

Dustproof and dripproof

Applicable Series

Series	Description	Model	Action	Note	Standard model page
MHK	Wedge cam operation slide guide	MHK2	Double acting, Single acting (Normally open, Normally closed)		P.676
		MHKL2	Double acting, Single acting (Normally open, Normally closed)		
MHS	3-finger type with dust cover	MHSJ3	Double acting		P.720
	With through hole and dust cover	MHSJ3	Double acting		P.728
MHZ	Parallel type with dust cover	MHZJ2	Double acting, Single acting (Normally open, Normally closed)	ø10, 16, 20, 25 only	P.528

How to Order

Standard part number for each series **-X77A**

Dust Cover Adhesion

How to Order

Standard part number for each series **-X77B**

Dust Cover Adhesion/Finger part only

- Note 1) For -X77B, only the finger part is bonded.
 Note 2) The relief port can be attached to both -X77A and -X77B.
 Note 3) The dust cover cannot be removed and replaced.
 Note 4) Be sure to connect the dust cover to the relief port used for dust cover breathing before operating.
 Note 5) For the single acting type, be sure to perform the piping to the breathing port.
 Note 6) For the body option applicable part number of the MHZJ2, only the E type can be applicable.

Specifications

Adhesive	Cyano superglue
----------	-----------------

Dimensions (Dimensions other than specified below are the same as the standard type.)

MHK²₁₂-□□□□-X77^A_B

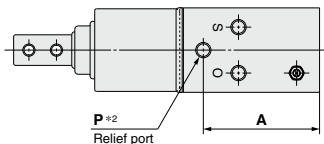
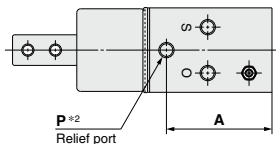
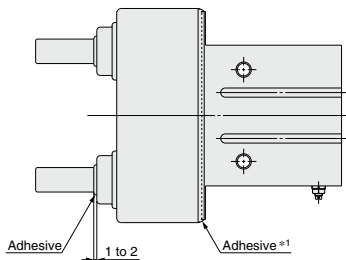
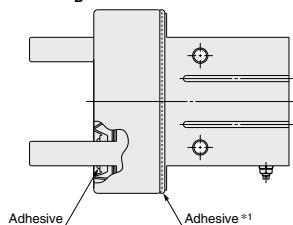

(mm)

Model	A	P
MHK2-12□□□□-X77 ^A _B	26.5	M3 x 0.5
MHK2-16□□□□-X77 ^A _B	28.5	
MHK2-20□□□□-X77 ^A _B	34.5	
MHK2-25□□□□-X77 ^A _B	37	M5 x 0.8
MHKL2-12□□□□-X77 ^A _B	31	M3 x 0.5
MHKL2-16□□□□-X77 ^A _B	33	
MHKL2-20□□□□-X77 ^A _B	38	M5 x 0.8
MHKL2-25□□□□-X77 ^A _B	44	

- *1) For -X77B, the body part is not bonded, but only the finger part.
 *2) Use the relief port after being piped.
 *3) For the single acting type, be sure to perform the piping to the breathing port. For the single acting type, the port on one side becomes the breathing port.

11 Dust Cover Adhesion (Powerful adhesive used)

Symbol
-X77

Dimensions (Dimensions other than specified below are the same as the standard type.)

MHSJ3-□□-X77^A_B
MHSJ3-□□□-X77^A_B

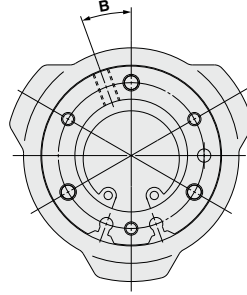
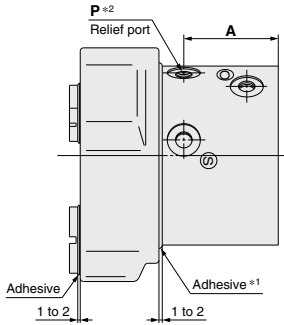

With center pusher

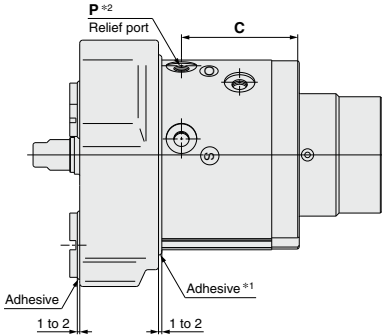

Model	A	B	C	P
MHSJ3-16D□-X77 ^A _B	21	25°	—	M3 x 0.5
MHSJ3-20D□-X77 ^A _B	21		—	
MHSJ3-25D□-X77 ^A _B	25	20°	—	M5 x 0.8
MHS ₃ 3-32D□□-X77 ^A _B	28.5		37.5	
MHS ₃ 3-40D□□-X77 ^A _B	29.5		38.5	
MHS ₃ 3-50D□□-X77 ^A _B	38		49	
MHS ₃ 3-63D□□-X77 ^A _B	41		54	
MHS ₃ 3-80D□□-X77 ^A _B	45		58	

- *1) For -X77B, the body part is not bonded, but only the finger part.
*2) Use the relief port after being piped.
*3) Body through-hole mounting is not possible.

MHZJ2-□□□-X77^A_B

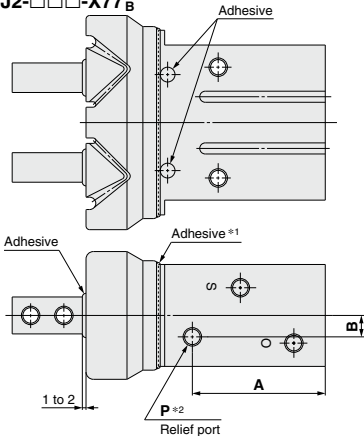

MHZJ2 Series

Model	A	B	P
MHZJ2-10□□-X77 ^A _B	27	4.2	M3 x 0.5
MHZJ2-16□□-X77 ^A _B	29	4.8	
MHZJ2-20□□-X77 ^A _B	36	5.8	M5 x 0.8
MHZJ2-25□□-X77 ^A _B	43	6.8	

- *1) For -X77B, the body part is not bonded, but only the finger part.
*2) Use the relief port after being piped.
*3) For the single acting type, be sure to perform the piping to the breathing port.

Made to Order Common Specifications: Air Gripper -X78^A: Dust Cover Caulking



12 Dust Cover Caulking (Silicone Caulking Agent Used)

Symbol
-X78

Dustproof and dripproof

Applicable Series

Series	Description	Model	Action	Note	Standard model page
MHK	Wedge cam operation slide guide	MHK2	Double acting, Single acting (Normally open, Normally closed)		P.676
		MHKL2	Double acting, Single acting (Normally open, Normally closed)		
MHS	3-finger type with dust cover	MHSJ3	Double acting		P.720
	With through hole and dust cover	MHSJ3	Double acting		P.728
MHZ	Parallel type with dust cover	MHZJ2	Double acting, Single acting (Normally open, Normally closed)	ø10, ø16, ø20, ø25 only	P.528

How to Order

Standard part number for each series **-X78A**

Dust Cover Caulking

How to Order

Standard part number for each series **-X78B**

Dust Cover Caulking/Finger part only

Note 1) For -X78B, caulking is applied to only the finger part.

Note 2) Relief port can be mounted on both -X78A and -X78B.

Note 3) Use the dust cover after being piped to the relief port for dust cover breathing.

Note 4) For the single acting type, be sure to perform the piping to the breathing port.

Note 5) For the body option applicable part number of the MHZJ2, only the E type can be applicable.

Specifications

Caulking agent	Silicone adhesive, sealant (white)
----------------	------------------------------------

Dimensions (Dimensions other than specified below are the same as the standard type.)

MHK²-□□□□-X78^A

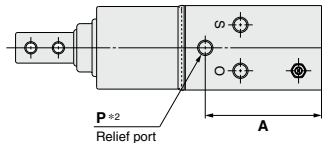
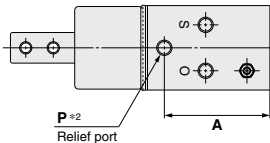
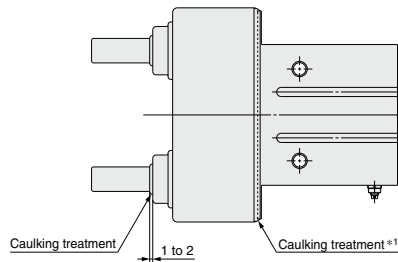
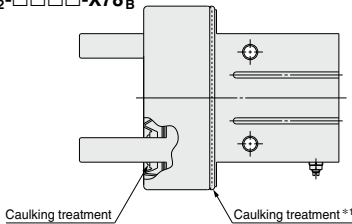

(mm)

Model	A	P
MHK2-12□□□-X78 ^A	26.5	M3 x 0.5
MHK2-16□□□-X78 ^A	28.5	
MHK2-20□□□-X78 ^A	34.5	
MHK2-25□□□-X78 ^A	37	M5 x 0.8
MHKL2-12□□□-X78 ^A	31	M3 x 0.5
MHKL2-16□□□-X78 ^A	33	
MHKL2-20□□□-X78 ^A	38	
MHKL2-25□□□-X78 ^A	44	M5 x 0.8

*1) Caulking treatment is not applied to the body of -X78B, but only to the finger part.

*2) Use the relief port after being piped.

*3) For the single acting type, be sure to perform the piping to the breathing port.

12 Dust Cover Caulking (Silicone Caulking Agent Used)

Symbol
-X78

Dimensions (Dimensions other than specified below are the same as the standard type.)

MHSJ3-□□□-X78^A
MHSHJ3-□□□□-X78^A

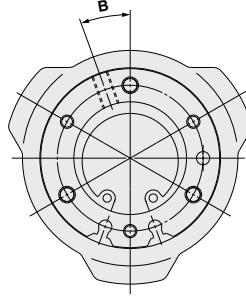
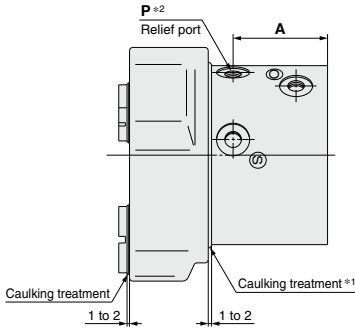

With center pusher

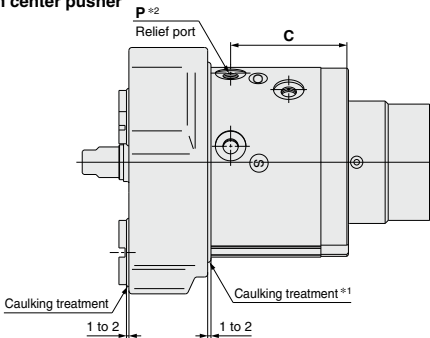

Model	A	B	C	P
MHSJ3-16D□□-X78 ^A	21	25°	—	M3 x 0.5
MHSJ3-20D□□-X78 ^A	21		—	—
MHSJ3-25D□□-X78 ^A	25	20°	—	M5 x 0.8
MHS ₃ 3-32D□□□-X78 ^A	28.5		37.5	
MHS ₃ 3-40D□□□-X78 ^A	29.5		38.5	
MHS ₃ 3-50D□□□-X78 ^A	38		49	
MHS ₃ 3-63D□□□-X78 ^A	41		54	
MHS ₃ 3-80D□□□-X78 ^A	45		58	

- *1) Caulking treatment is not applied to the body of -X78B, but only to the finger part.
- *2) Use the relief port after being piped.
- *3) Body through-hole mounting is not possible.

MHZJ2-□□□□-X78^A

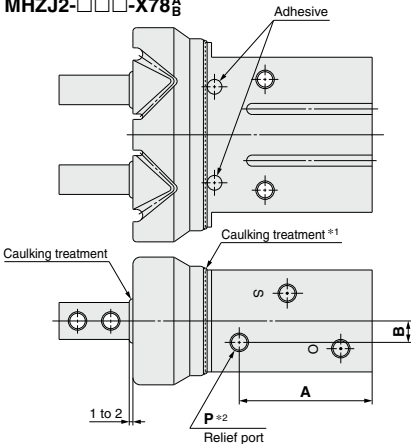

MHZJ2 Series

Model	A	B	P
MHZJ2-10□□□-X78 ^A	27	4.2	M3 x 0.5
MHZJ2-16□□□-X78 ^A	29	4.8	
MHZJ2-20□□□-X78 ^A	36	5.8	M5 x 0.8
MHZJ2-25□□□-X78 ^A	43	6.8	

- *1) Caulking treatment is not applied to the body of -X78B, but only to the finger part.
- *2) Use the relief port after being piped.
- *3) For the single acting type, be sure to perform the piping to the breathing port.

Made to Order Common Specifications: Air Gripper -X79: Grease for Food Processing Machines/Fluorine Grease



13 Grease for Food Processing Machines

Symbol
-X79

Use grease for food processing machines (NSF-H1 certified/fluorine grease).

Applicable Series

Series	Description	Model	Action	Note	Standard model page
MHC	Angular type	MHC2	Double acting, Single acting (Normally open)		P.807
		MHCA2	Double acting, Single acting (Normally open)		P.796
		MHCM2	Single acting (Normally open)		P.805
MHF	Low profile	MHF2	Double acting		P.560
MHK	Wedge cam operation slide guide	MHK2	Double acting, Single acting (Normally open, Normally closed)		P.676
		MHKL2	Double acting, Single acting (Normally open, Normally closed)		
MHL2	Wide type	MHL2-Z	Double acting		P.617
		MHL2	Double acting		P.639
MHS	2-finger type	MHS2	Double acting		P.702
	3-finger type	MHS3	Double acting		P.710
	3-finger type with dust cover	MHSJ3	Double acting		P.720
	With through hole	MHSH3	Double acting		P.728
	With through hole and dust cover	MHSHJ3	Double acting		
	Long stroke 3-finger type	MHSL3	Double acting		P.744
MHW	180° angular type	MHS4	Double acting		P.754
		MHW2	Double acting		P.843
MHY	180° angular type cam type	MHY2	Double acting		P.836
MHZ	Parallel type (compact)	MHZA2	Double acting, Single acting (Normally open, Normally closed)		P.486
	Parallel type with dust cover (compact)	MHZAJ2	Double acting, Single acting (Normally open, Normally closed)		
	Parallel type	MHZ2	Double acting, Single acting (Normally open, Normally closed)		P.496 to 498
	Parallel type (long stroke)	MHZL2	Double acting, Single acting (Normally open, Normally closed)		P.514
	Parallel type with dust cover	MHZJ2	Double acting, Single acting (Normally open, Normally closed)		P.528

How to Order

Standard part number for each series -X79

Grease for Food Processing Machines

(Note) For lubrication, specialized grease GR-H is recommended.

Specifications

Grease	Grease for Food Processing Machines (NSF-H1 certified)/Fluorine Grease
Specifications/dimensions other than the above	Same as the standard type for each series

* If the fluorine grease is not applicable to the working environment, please use "-X79A."

Warning

Handling Precautions

Be aware that smoking cigarettes after your hands have come into contact with the grease used for this air gripper can create a gas that is hazardous to humans.

Caution

Do not use air grippers in a food-related environment.

<Cannot be mounted>

Food zone.....Food may directly contact with air grippers, and is treated as food products.

<Can be mounted>

Splash zone.....Food may directly contact with air grippers, but is not treated as food products.

Non-food zone.....Air grippers do not directly contact food.

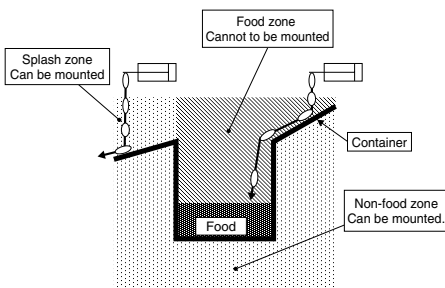

Made to Order Common Specifications: Air Gripper -X79A: Grease for Food Processing Machines



14 Grease for Food Processing Machines

Symbol
-X79A

Use grease for food processing machines (NSF-H1 certified).

Applicable Series

Series	Description	Model	Action	Note	Standard model page
MHC	Angular type	MHC2	Double acting, Single acting (Normally open)		P.807
		MHCA2	Double acting, Single acting (Normally open)		P.796
		MHCM2	Single acting (Normally open)		P.805
MHF	Low profile	MHF2	Double acting		P.560
MHK	Wedge cam operation slide guide	MHK2	Double acting, Single acting (Normally open, Normally closed)		P.676
		MHKL2	Double acting, Single acting (Normally open, Normally closed)		
MHL2	Wide type	MHL2-Z	Double acting		P.617
		MHL2	Double acting		P.639
MHS	2-finger type	MHS2	Double acting		P.702
	3-finger type	MHS3	Double acting		P.710
	3-finger type with dust cover	MHSJ3	Double acting		P.720
	With through hole	MHSH3	Double acting		P.728
	With through hole and dust cover	MHSHJ3	Double acting		
	Long stroke 3-finger type	MHSL3	Double acting		P.744
MHW	180° angular type	MHS4	Double acting		P.754
		MHW2	Double acting		P.843
MHY	180° angular type cam type	MHY2	Double acting		P.836
MHZ	Parallel type (compact)	MHZA2	Double acting, Single acting (Normally open, Normally closed)		P.486
	Parallel type with dust cover (compact)	MHZAJ2	Double acting, Single acting (Normally open, Normally closed)		
	Parallel type	MHZ2	Double acting, Single acting (Normally open, Normally closed)		P.496 to 498
	Parallel type (long stroke)	MHZL2	Double acting, Single acting (Normally open, Normally closed)		P.514
	Parallel type with dust cover	MHZJ2	Double acting, Single acting (Normally open, Normally closed)		P.528

How to Order

Standard part number for each series – **X79A**

Grease for Food Processing Machines

(Note) For lubrication, specialized grease GR-R is recommended.

Specifications

Grease	Grease for Food Processing Machines (NSF-H1 certified)/Aluminum Complex Soap Base Grease
Specifications/dimensions other than the above	Same as the standard type for each series

⚠ Caution

Do not use air grippers in a food-related environment.

<Cannot be mounted>

Food zone.....Food may directly contact with air grippers, and is treated as food products.

<Can be mounted>

Splash zone.....Food may directly contact with air grippers, but is not treated as food products.

Non-food zone.....Air grippers do not directly contact food.

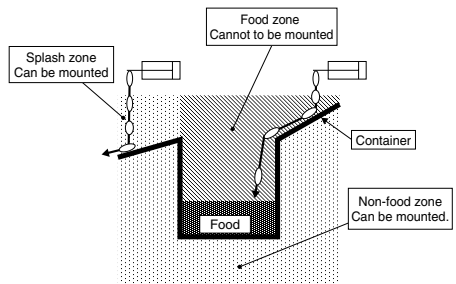

Made to Order Common Specifications: Air Gripper -X81_A_B: Anti-corrosive Treatment of Finger



15 Anti-corrosive Treatment of Finger

Symbol
-X81

- Special black chromium treatment
- The finger and guide use the martensitic stainless steel. When anti-corrosive measures better than the martensitic stainless steel level are required, use these series.

Applicable Series

Series	Description	Model	Action	Note	Standard model page
MHC	Angular type	MHC2	Double acting, Single acting (Normally open)		P.807
		MHCA2	Double acting, Single acting (Normally open)		P.796
		MHCM2	Single acting (Normally open)		P.805
MHF	Low profile	MHF2	Double acting		P.560
MHY	180° angular type cam type	MHY2	Double acting		P.836
	Parallel type (compact)	MHZA2	Double acting, Single acting (Normally open, Normally closed)		P.486
MHZ	Parallel type with dust cover (compact)	MHZA2	Double acting, Single acting (Normally open, Normally closed)		
	Parallel type	MHZ2	Double acting, Single acting (Normally open, Normally closed)		P.496 to 498
	Parallel type (long stroke)	MHZL2	Double acting, Single acting (Normally open, Normally closed)		P.514
	Parallel type with dust cover	MHZJ2	Double acting, Single acting (Normally open, Normally closed)		P.528

How to Order

Standard part number for each series **-X81A**

Anti-corrosive Treatment of Finger •

Applicable Series

Series	Description	Model	Action	Note	Standard model page
MHF	Low profile	MHF2	Double acting		P.560
	Parallel type (compact)	MHZA2	Double acting, Single acting (Normally open, Normally closed)		P.486
MHZ	Parallel type	MHZ2	Double acting, Single acting (Normally open, Normally closed)		P.496 to 498
	Parallel type (long stroke)	MHZL2	Double acting, Single acting (Normally open, Normally closed)		P.514

How to Order

Standard part number for each series **-X81B**

Anti-corrosive Treatment of Finger and Guide •

Specifications

Treatment	Special black chromium treatment
Specifications/dimensions other than the above	Same as the standard type for each series